



**PART No. 2CSD83643**

for more information visit

[www.hammfg.com](http://www.hammfg.com)

Data subject to change without notice

Isometric drawing Not to Scale

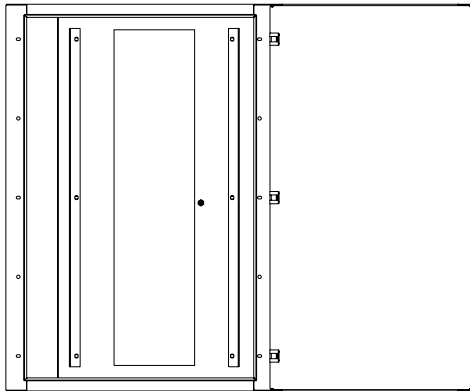

TOP VIEW

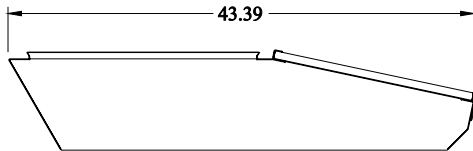

LEFT SIDE VIEW

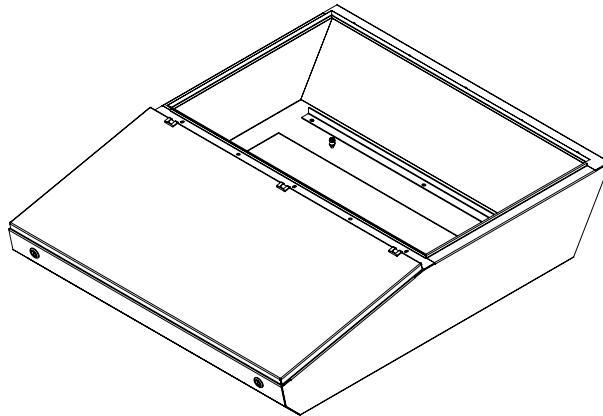

ISOMETRIC VIEW

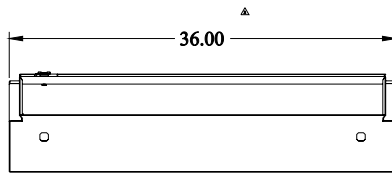

FRONT VIEW

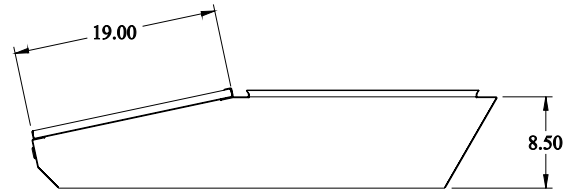

RIGHT SIDE VIEW