

PART NUMBER	SML-LXIL2324USBC-TR	REV.	B
DATE	E.C.N. NUMBER AND REVISION COMMENTS		REV.
10.03.13	E.C.N. #10BRDR. & REDRAWN.		A
10.03.13	E.C.N. #11880.		B

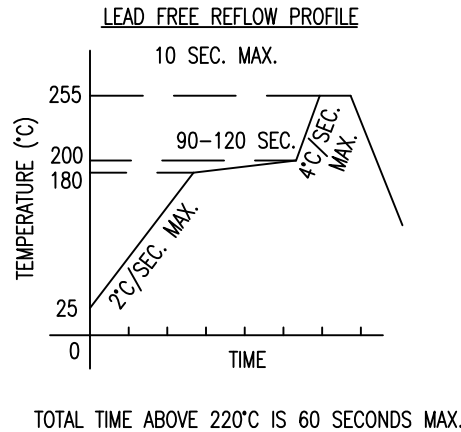

ELECTRO-OPTICAL CHARACTERISTICS  $T_A=25^\circ\text{C}$   $I_f=20\text{mA}$

PARAMETER	SYMBOL	MIN	TYP	MAX	UNITS	TEST COND
DOMINANT WAVELENGTH			470		nm	
FORWARD VOLTAGE	$V_f$		3.0	3.5	V	$I_f=20\text{mA}$
REVERSE VOLTAGE	$V_r$			5	V	$I_r=10\mu\text{A}$
AXIAL INTENSITY	$I_v$		30000		mcd	$I_f=20\text{mA}$
VIEWING ANGLE	1/2 theta		8		deg	
EMITTED COLOR:	BLUE					
EPOXY LENS FINISH:	WATER CLEAR					

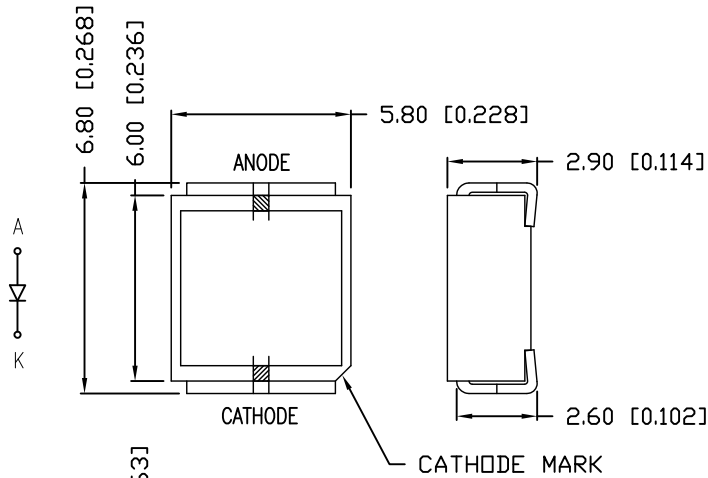
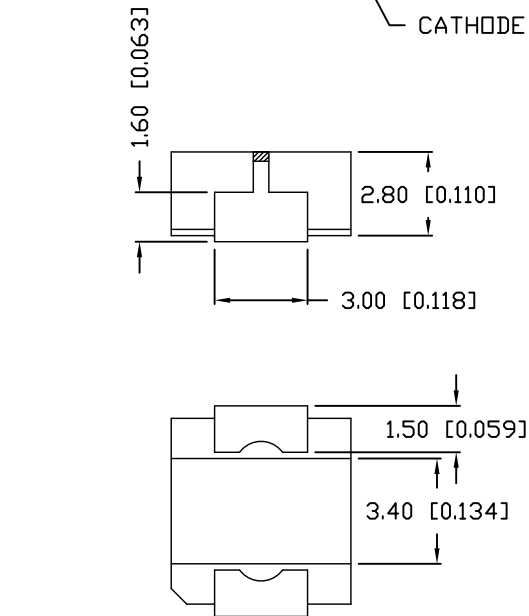

**PAD LAYOUT**

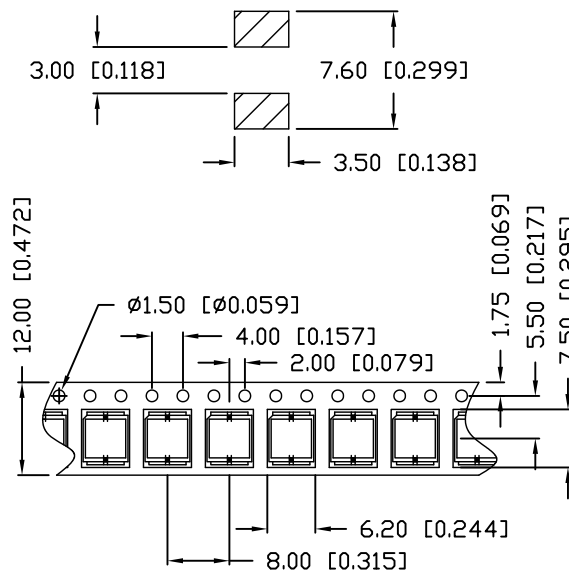

**LIMITS OF SAFE OPERATION AT 25°C**

PARAMETER	SYMBOL	MAX	UNITS
STEADY CURRENT	$I_F$	30	mA
POWER DISSIPATION	$P_D$	120	mW
OPERATING TEMP.	$T_{OPR}$	-30 TO +85	°C
STORAGE TEMP.	$T_{STG}$	-30 TO +90	°C

**NOTES:**

CATHODE IS ORIENTED TOWARDS THE TAPE SPOCKET HOLE.

**CAUTION: MOISTURE SENSITIVE DEVICE**  
PER JEDEC LEVEL 4 STANDARDS

\*UNLESS OTHERWISE SPECIFIED TOLERANCES PER DECIMAL PRECISION ARE: X=±1 (±0.039), X.X=±0.5 (±0.020), X.XX=±0.25 (±0.010), X.XXX=±0.127 (±0.005). LEAD SIZE=±0.05 (±0.002), LEAD LENGTH=±0.75 (±0.030). MIN=<sup>+DECIMAL PRECISION</sup>-0.00, MAX.=<sup>+0.00</sup>-DECIMAL PRECISION

PART NUMBER	SML-LXIL2324USBC-TR	REV.	B
DATE	E.C.N. NUMBER AND REVISION COMMENTS		REV.
10.03.13	E.C.N. #10BRDR. & REDRAWN.		A
10.03.13	E.C.N. #11880.		B

A

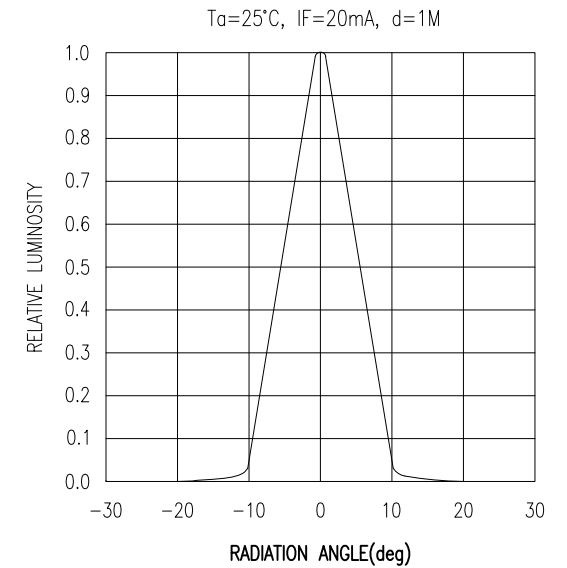
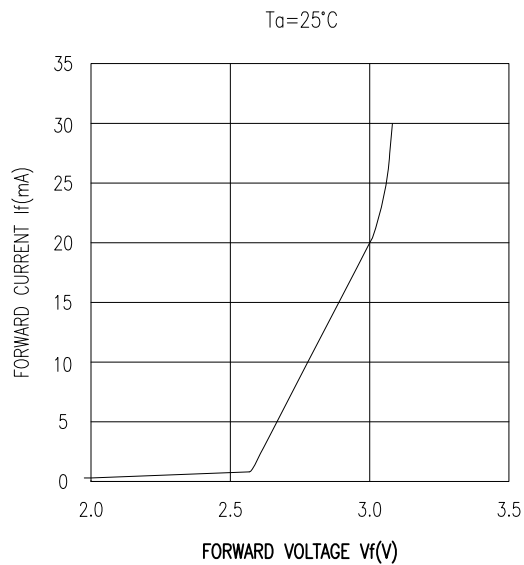
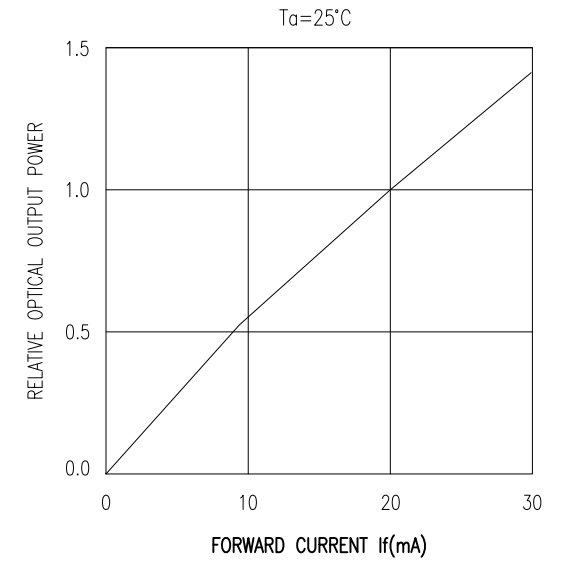
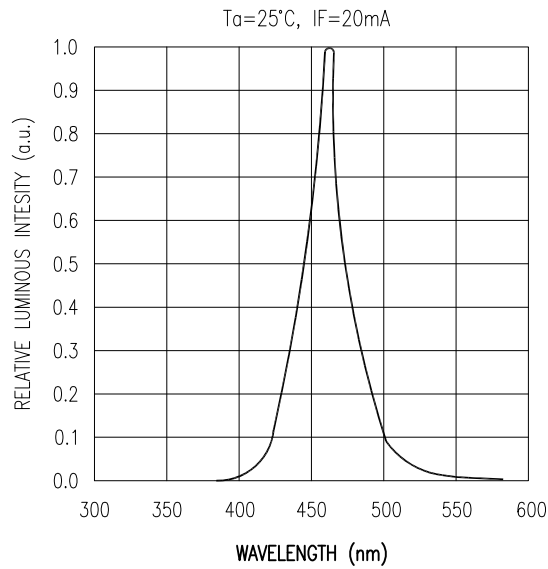
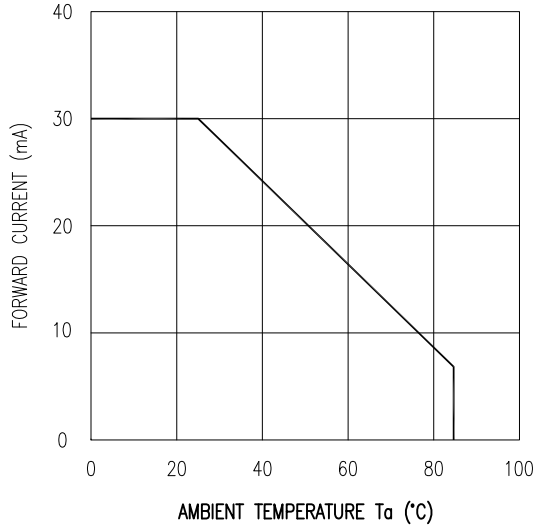

\*UNLESS OTHERWISE SPECIFIED TOLERANCES PER DECIMAL PRECISION ARE: X=±1 (±0.039), X.X=±0.5 (±0.020), X.XX=±0.25 (±0.010), X.XXX=±0.127 (±0.005). LEAD SIZE=±0.05 (±0.002), LEAD LENGTH=±0.75 (±0.030). MIN.=<sup>+DECIMAL PRECISION</sup><sub>-0.00</sub> MAX.=<sup>+0.00</sup><sub>-DECIMAL PRECISION</sub> UNCONTROLLED DOCUMENT



425 N. GARY AVE.  
CAROL STREAM, IL 60188-4900  
PHONE: +1.800.278.5666  
FAX: +1.630.315.2152  
WEB: WWW.LUMEX.COM  
MEMBER OF ITW PHOTONICS GROUP

NARROW BEAM 6mm SMT LED, 470nm BLUE LED, WATER CLEAR LENS.

\*\*THE SPECIFICATIONS MAY CHANGE AT ANY TIME WITHOUT NOTICE DUE TO NEW MATERIALS OR PRODUCT IMPROVEMENT.\*\*

CONFIDENTIAL INFORMATION

THE INFORMATION CONTAINED IN THIS DOCUMENT IS THE PROPERTY OF LUMEX INC. EXCEPT AS SPECIFICALLY AUTHORIZED IN WRITING BY LUMEX INC., THE HOLDER OF THIS DOCUMENT SHALL KEEP ALL INFORMATION CONTAINED HEREIN CONFIDENTIAL AND SHALL PROTECT SAME IN WHOLE OR IN PART FROM DISCLOSURE AND DISSEMINATION TO ALL THIRD PARTIES.

DATE: 10.03.13	DRAWN BY: MA
PAGE: 2 OF 2	CHKD BY: AA
SCALE: NTS	APRVD BY: AA
UNIT: mm [INCH]	Ⓟ