

WWW.CROUZET-MOTORS.COM

TNi21 DCMIND BRUSHLESS MOTORS

USER AND SAFETY MANUAL

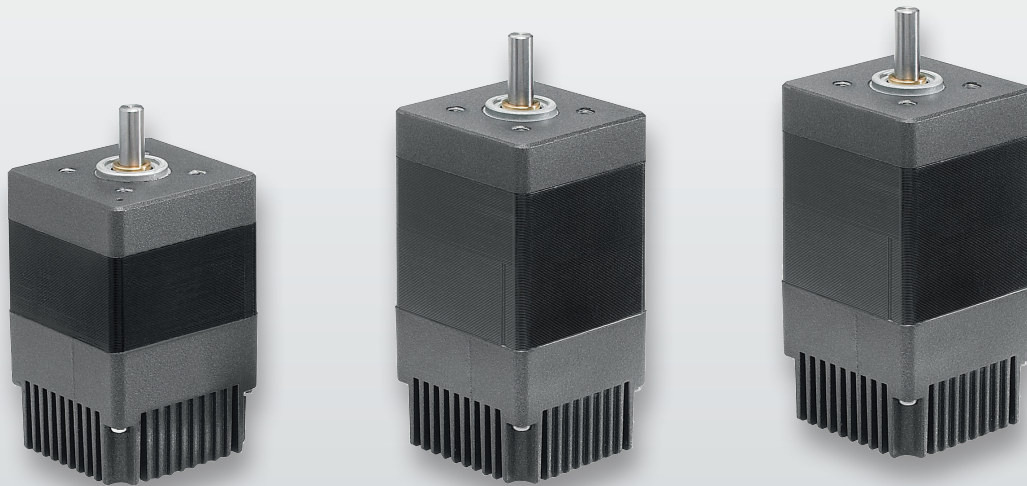

TNi21 DCmind brushless motors

User and safety manual

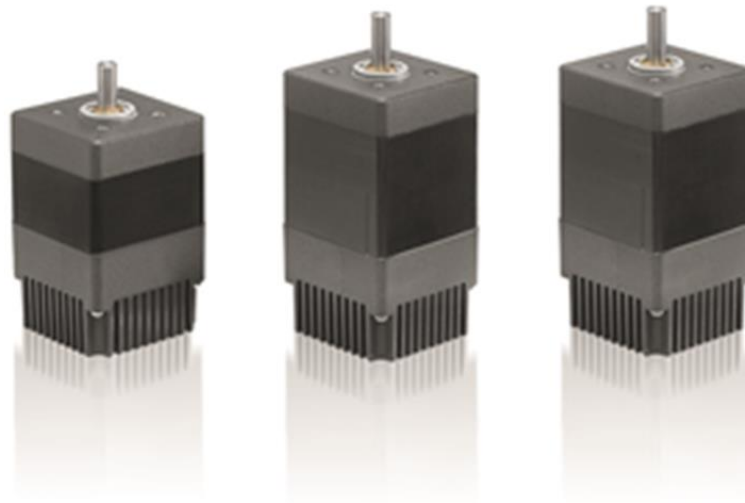

Important notes

- This manual is part of the product.
- Read and follow the instructions in this manual.
- Keep this manual in a safe place.
- Give this manual and any documents relating to the product to anyone using the product.
- Read and follow closely all the safety instructions in the "Before you start - Safety information" section.
- Please see the current catalogue for the product's technical specification.
- We reserve the right to make modifications without prior notice.
- Unless otherwise stated in writing by Crouzet Automatismes, any use of the products described herein automatically signifies unconditional acceptance by the user of our general conditions of sale and the waiver of any stipulations which might be printed on its orders or correspondence. Crouzet Automatismes accepts no liability for any malfunction or damage caused by the user, due to the use of this manual or the instructions herein.

Table of contents

1.	Introduction	5
1.1.	Motor family.....	5
1.2.	Features	5
1.3.	Options	5
1.4.	Identification label	5
1.5.	Product coding	6
2.	Before you start - Safety information	7
2.1.	Qualification of personnel.....	7
2.2.	Use for intended purpose.....	7
2.3.	Basic information.....	8
2.4.	Standards and concepts	9
3.	Precautions for use at a mechanical level	10
3.1.	Data specific to the motor shaft	10
3.1.1.	Force applied when pushing items on to the shaft.....	10
3.1.2.	Radial load on the shaft.....	10
3.2.	Options	11
3.2.1.	Holding brake	11
3.2.2.	Gearboxes	11
3.2.3.	Others.....	11
4.	Installation.....	12
4.1.	Snapshot of the installation procedure.....	14
4.2.	Electromagnetic compatibility, EMC	14
4.3.	Before fitting	15
4.4.	Fitting the motor	16
4.5.	Electrical installation.....	17
4.5.1.	Connecting the holding brake (option)	19
4.6.	Production connector	20
5.	Switching on.....	21
5.1.	Preparations for switching on.....	21
6.	Product presentation.....	23
6.1.	Description of the product	23
6.2.	TNI21 control electronics	23
7.	Technical characteristics	24
7.1.	Electrical data.....	24
7.2.	Generic data.....	24
7.3.	Control logic bundle	25
7.4.	Power supply cable	26
8.	Motor electrical connection	27

- 8.1. Power connection.....27
 - 8.1.1. Ballast circuit27
 - 8.1.2. Protection for EMC29
- 8.2. Protective devices30
 - 8.2.1. Voltage protection.....30
 - 8.2.2. Temperature protection30
 - 8.2.3. Current limiting31
- 8.3. Connecting inputs/outputs.....31
 - 8.3.1. Equivalent inputs diagram31
 - 8.3.2. Equivalent outputs diagram32
- 9. Operating mode33
 - 9.1. Preliminaries33
 - 9.2. Functions associated with inputs33
 - 9.2.1. Function E1 - On / Off33
 - 9.2.2. Function E2 - Direction of rotation.....33
 - 9.2.3. Function E3 - Speed set-point.....33
 - 9.2.4. Function E4 - Torque limiter set-point34
 - 9.3. Functions associated with outputs34
 - 9.3.1. Function S1 - Encoder output.....34
 - 9.3.2. Function S2 - Torque limiter output.....34
 - 9.3.3. Function S3 - Actual direction of rotation output34
 - 9.4. SAFE mode35
- 10. Diagnostics and troubleshooting35
 - 10.1. Mechanical faults35
 - 10.2. Electrical problems.....35
- 11. Service, maintenance and problem solving36
 - 11.1. Addresses of after-sales service points36
 - 11.2. Storage.....36
 - 11.3. Maintenance.....36
 - 11.4. Replacing the motor37
 - 11.5. Shipping, storage, disposal37
 - 11.6. Terms and abbreviations.....38

About this manual

This manual applies to TNi21 DCmind brushless products:

- 801400TNi21, 801495TNi21, 801496TNi21, 801410TNi21,
- 801800TNi21, 801896TNi21, 801897TNi21, 801810TNi21,
- 802800TNi21, 802896TNi21, 802897TNi21, 802810TNi21,

Reference source for manuals

Manuals are available to download from the Internet at the following address

<http://www.crouzet.com/>

Units

By default, units rotate anti-clockwise.

Risk categories

In this manual, safety instructions are identified by warning symbols.

Safety instructions are divided into three risk categories, depending on the gravity of the situation.

DANGER

DANGER indicates an immediately dangerous situation, which, if instructions are not followed, would **inevitably** result in a serious or fatal accident.

WARNING

WARNING indicates a potentially dangerous situation which, if instructions are not followed, could **in certain cases** result in a serious or fatal accident or cause damage to equipment.

CAUTION

CAUTION indicates a potentially dangerous situation which, if instructions are not followed, could **in certain cases** result in an accident or cause damage to equipment.

1. INTRODUCTION

1.1. Motor family

TNi21 DCmind brushless motors are direct current brushless motors with a built-in electronic control board.

1.2. Features

TNi21 DCmind brushless motors are intelligent servomotors for speed and torque control applications. They are fitted with two unscreened cables as standard, one for power and one for control.

1.3. Options

Motors may be supplied with options such as:

- a range of gearboxes
- a holding brake in the event of loss of current
- various motor output shaft versions

1.4. Identification label

The label carries the following information:

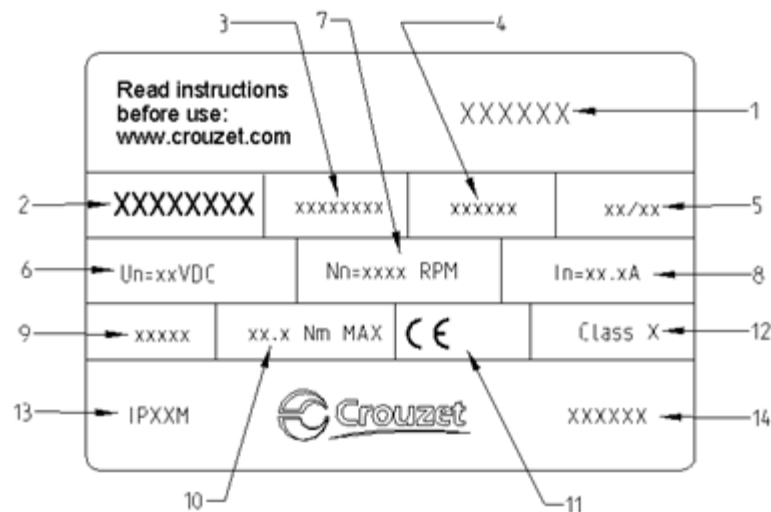

Figure 1

1. Product family code
2. Product reference
3. Reserved area
4. Area reserved for special customer markings
5. Date manufactured: week/year
6. Operating voltage
7. The motor's rated speed at 24V
8. The motor's rated current
9. Gear ratio (for versions with gearboxes)
10. Maximum nominal torque applicable to gearboxes (for versions with gearboxes).
11. Motor approvals.
12. Insulation system temperature class.
13. Degree of protection (sealing) of the product during operation (apart from the output shaft).
14. Country of manufacture

1.5. Product coding

80 XX XX TNi21: Product family based on TNi21 electronics

PRODUCT REFERENCE	8 0	X X	X X	X X
Motor				
Type of stator:				
14: 30 mm brushless stator				
18: 50mm brushless stator				
28: 50mm brushless stator high torque				
Gearboxes fitted:				
00: no gearbox				
10: RAD10 gearbox				
95: P52 gearbox				
96: P62 gearbox				
97: P81 gearbox				
Incrementing numbers				

2. BEFORE YOU START - SAFETY INFORMATION

2.1. Qualification of personnel

Only qualified personnel, familiar with and understanding the contents of this manual, are authorised to work on and with this product.

Qualified personnel should have a sound knowledge of current standards, regulations and requirements with regard to accident prevention, when carrying out work on or with the product.

Those personnel must have undergone safety training, so that they are able to detect and prevent any associated danger.

By virtue of their professional training, knowledge and experience, these qualified personnel should be able to provide warning or recognise potential dangers, that could be caused by use of the product, modifying its settings or those of mechanical, electrical and electronic equipment in the installation in general.

2.2. Use for intended purpose

As stated in these instructions, this product is a component intended for use in an industrial environment. The safety instructions in force, specified conditions and technical characteristics must be respected at all times.

Before using the product for the first time, a risk analysis should be carried out on its use in practice. Depending on the result, any necessary safety measures should be taken.

Since the product is used as a component in an overall system, it is the user's responsibility to ensure the safety of persons through the design of the overall system, e.g. machine design.

Use only original spare parts and accessories.

The product must not be used in an explosive atmosphere (Ex zone).

Any other use is considered as non-compliant and could cause danger.

Only duly qualified personnel are authorised to install, operate, maintain and repair electrical devices and equipment.

2.3. Basic information

 **DANGER****DANGER DUE TO ELECTRIC SHOCK, EXPLOSION OR EXPLOSION DUE TO AN ELECTRICAL ARC**

- Only qualified personnel, familiar with and understanding the contents of this manual, are authorised to work on and with this product. Only qualified personnel are authorised to install, adjust, repair and maintain it.
- The person/entity constructing the installation is responsible for compliance with all applicable requirements and regulations concerning the earthing of the drive system.
- It is the user's responsibility to determine whether it is necessary to earth the motor, depending on its use.
- Do not touch unprotected live parts.
- Use only electrically insulated tools.
- AC voltages may flow along unused conductors in the motor cable. Isolate unused conductors at both ends of the motor cable.
- The motor produces a voltage when the shaft rotates. Isolate the motor shaft from any external power supply, before carrying out any work on the drive system.
 - Switch off all connections
 - Attach a "DO NOT SWITCH ON" sign on all switches.
 - Prevent all switches from being re-engaged.
 - Wait for the motor's internal capacitors to discharge.. Measure the voltage in the power cable and check that it is less than 12V DC.
- Fit and close all protective covers before re-applying power..

Failure to take these precautions could result in death or serious injury.

 **WARNING****LOSS OF CONTROL**

• When designing the control of the installation, the manufacturer should keep in mind the implications of a potential failure in control paths and, for certain critical functions, provide a method for returning to a safe state during and after the failure of a control path.

Examples of critical control functions are:

EMERGENCY STOP, restricting the final position, network interruption and re-starting.

- Separate or redundant control paths must be available for critical functions.
- Follow accident prevention instructions and all applicable safety directives.
- Any installation in which the product described in this manual is used must be carefully and minutely checked to ensure that it is operating correctly, before it is switched on.

If these precautions are not taken, the result could be death or serious injury.

 **WARNING****UNBRAKED MOVEMENT**

In the event of a loss of power to the power stage, the motor is no longer braked in a controlled way and could cause damage.

- Prevent access to the risk area..
- If necessary, use a damped mechanical stop or a service brake.

If these precautions are not taken, the result could be death, serious injury or damage to equipment.

2.4. Standards and concepts

This product complies with European ROHS Directive 2011/65/EC and is CE marked.

The product's electrical design complies with standards IEC 60335-1 and IEC 60950-1.

3. PRECAUTIONS FOR USE AT A MECHANICAL LEVEL

3.1. Data specific to the motor shaft

3.1.1. Force applied when pushing items on to the shaft

 WARNING
<p>MECHANICAL CHARACTERISTICS OF THE MOTOR Exceeding the maximum permitted force on the shaft will result in rapid wearing of the bearings, a broken shaft or the deterioration of any accessories (encoder, brake, etc.)</p> <ul style="list-style-type: none">• Never exceed the max. permissible radial or axial forces on the motor.• Protect the shaft against impacts.• When pushing items in to the shaft, do not exceed the maximum permitted axial force. <p>If these precautions are not taken, the result could be death, serious injury or damage to equipment.</p>

The maximum force when pushing items on to the shaft is limited by the maximum permitted axial force acting on the ball bearings.

This maximum axial force is given in the motor's data sheet.

Alternatively, the item to be attached can be secured by clamping, bonding or binding.

3.1.2. Radial load on the shaft

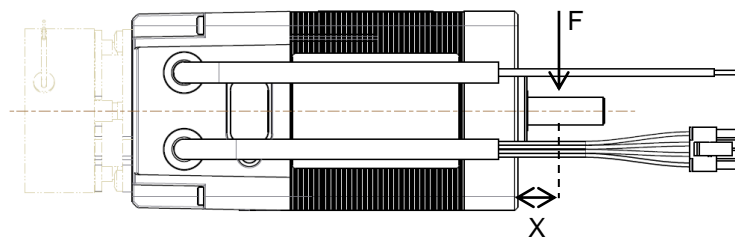

Figure 2

The point of application **X** of the radial force **F** depends on the size of the motor. This information is shown in the motor's data sheet.

The maximum radial and axial loads should not be applied simultaneously, so as to maximise the motor's service life.

3.2. Options

3.2.1. *Holding brake*

TNi21 DCmind brushless motors can be fitted with a fail safe electromechanical brake. The holding brake is designed to prevent the shaft from rotating when there is no power to the motor. The holding brake has no safety function. The "Connecting a holding brake" section describes how it should be controlled.

3.2.2. *Gearboxes*

TNi21 DCmind brushless motors may be fitted with various types of gearbox. The gearboxes offered in the standard catalogue are planetary gearboxes, combining compactness with strength, and worm gearboxes that provide output from the shaft at right angles to the motor shaft.

3.2.3. *Others*

Other types of adaptation are possible upon request. Please contact our sales department.

4. INSTALLATION

In a general sense, motors should be installed in line with good industrial practice.

 **WARNING****CONSIDERABLE WEIGHT AND FALLING PARTS**

The motor can weigh a lot.

- Take the motor's weight into consideration when fitting it.
- Fit the motor (tightening torque of screws) in such a way that it cannot come adrift, even in the event of high levels of acceleration or permanent vibration.

If these precautions are not taken, the result could be death, serious injury or damage to equipment.

 **WARNING****STRONG ELECTROMAGNETIC FIELDS**

Motors can generate powerful local electrical and magnetic fields. They can cause sensitive equipment to fail.

- Keep persons wearing implants such as heart pacemakers away from the motor.
- Do not position sensitive equipment in the immediate proximity of the motor.

If these precautions are not taken, the result could be death, serious injury or damage to equipment.

 **WARNING****UNEXPECTED BEHAVIOUR AS A RESULT OF DETERIORATION OR FOREIGN BODIES**

As a result of deterioration of the product, the presence of foreign bodies or deposits or penetration by fluids, unexpected behaviour can occur.

- Do not use damaged products..
- Do not allow any foreign body to enter the product.
- Check that seals and power cable glands are correctly fitted.
- Check that the plug protecting the motor's internal connector is fitted correctly.

If these precautions are not taken, the result could be death, serious injury or damage to equipment.

 **WARNING****HOT SURFACES**

The metal surface of the product can reach more than 70°C during use.

Avoid all contact with the metal surface.

- Do not position inflammable or heat-sensitive components in immediate proximity.
- Try to achieve an assembly that allows heat to dissipate efficiently.

If these precautions are not taken, the result could be injury or damage to equipment.

 **WARNING****DETERIORATION OR DESTRUCTION OF THE MOTOR DUE TO OVER-STRESSING**

The motor is not designed to withstand loads. If the motor is stressed, it could be damaged or even fall.

- Do not stand on the motor.
- Prevent the motor being used in any other way than its intended purpose by taking protective measures and following the safety instructions.

If these precautions are not taken, the result could be injury or damage to equipment.

 **CAUTION****OVER-VOLTAGES**

During braking phases, the motor generates over-voltages.

- Check that these over-voltages are acceptable to other equipment connected to the same power supply.
- Preferably, use an external circuit, to limit over-volting

In cases where braking is used intensively.

If these precautions are not taken, the result could be injury or damage to equipment.

4.1. Snapshot of the installation procedure

The installation procedure is described in the follow sections:

- Electromagnetic compatibility, EMC
- Before fitting
- Fitting the motor
- Electrical installation

Check that these sections have been read and understood and that, subsequently, the motor has been installed correctly.

4.2. Electromagnetic compatibility, EMC

 **DANGER**

INTERFERENCE AFFECTING SIGNALS AND EQUIPMENT
 Interference with signals can cause equipment to behave unpredictably

- Wiring should be done in accordance with the EMC recommendations specific to each device.
- Ensure that these EMC recommendations are followed correctly.

If these precautions are not taken, the result could be death, serious injury or damage to equipment.

Recommendations with regard to EMC: installing the motor's power supply wiring.

At the wiring planning stage, consider that the motor's power supply wiring must be installed isolated from network or signal transmission cables.

Take the following measures with regard to EMC.

EMC measures	Effect
Keep cables as short as possible. Do not install loops of unused cable.	Reduce interference, capacitive and inductive couplings.
Earth the product.	Reduce emissions; increase immunity to interference,
Where shielded cables are used, the cable shielding should be fitted to the widest possible surface area. Use cable clamps and earth bands.	Reduce emissions.
Position the motor's power supply wires separate from cables that carry signals or use screening plates.	Reduce mutual interference
If screened cables are used, fit them without an isolation point. ¹⁾	Reduce radiating interference.

1) Where the installation requires a cable to be cut, cables must be connected at the isolation point via a shielded cable inside a metal enclosure.

Equipotential link conductors

Where screened cables are used, differences in voltage can cause currents not permitted in screened cables. Fit equipotential link conductors to reduce current in screened cables.

4.3. Before fitting

Look for damage

Damaged drive systems should not be fitted or used.

⇒ Check the drive system before fitting and look for visible signs of damage.

Cleaning the shaft

On leaving the factory, the ends of the motor shafts are coated with film of oil.

Where transmission devices are to be fitted by bonding, it may be necessary to remove that oil film and clean the shaft. Where necessary, use degreasing products recommended by the manufacturer of the bonding adhesive.

⇒ Avoid all contact between the skin and sealing materials and the cleaning product used.

Fitting surface for the flange

The fitting surface must be stable, flat and clean.

⇒ On the installation side, ensure compliance with all dimensions and tolerances.

Specification for power supply wires.

The power supply wires for the motor and its accessories must be selected with care according to their length, the motor's supply voltage, the ambient temperature, the current passing through them and their environment.



WARNING

DETERIORATION AND FIRE FOLLOWING INCORRECT INSTALLATION

Forces and movement in cable glands can damage cables.

- Comply with the stated bend radius
- Avoid subjecting cable glands to forces or movement.
- Secure supply cable close to cable glands using a strain relief clamp.

If these precautions are not taken, the result could be injury or damage to equipment.

4.4. Fitting the motor

 **DANGER****HOT SURFACES**

The surface of the motor can reach more than 70°C during use.

- Avoid contact with hot surfaces.
- Do not position inflammable or heat-sensitive components in immediate proximity.
- Try to achieve an assembly that allows heat to dissipate efficiently.
- Run a test to check the temperature.

If these precautions are not taken, the result could be injury or damage to equipment.

 **WARNING****UNEXPECTED MOVEMENT DUE TO ELECTROSTATIC DISCHARGES**

In rare cases, electrostatic discharges (ESD) on the shaft can cause faults in the encoding system and unexpected movements of the motor.

- Use conductive components, e.g. anti-static belts or other appropriate measures to prevent any static charge due to movement.

If these precautions are not taken, the result could be death, serious injury or damage to equipment.

 **WARNING****UNINTENDED BEHAVIOUR DUE TO MECHANICAL DETERIORATION OF THE MOTOR**

Exceeding the maximum permissible forces on the shaft will result in rapid wear of the bearings, a broken shaft or damage to the internal encoder.

- Never exceed the max. permissible radial or axial forces on the motor.
- Protect the shaft against impacts.
- When pushing items on to the shaft, do not exceed the maximum permitted axial force.

If these precautions are not taken, the result could be death, serious injury or damage to equipment.

Installation position

The motor can be installed in any position.

Installation

When fitting the motor on the flange, it must be aligned precisely, both axially and radially. All securing screws must be tightened to the torque prescribed by the application, taking care not to cause any warping.

Fitting transmission devices

Fitting transmission devices incorrectly could damage the motor.

Transmission devices such as pulleys and gears must be fitted with reference to the maximum axial and radial forces specified in the data sheet for each motor.

Follow the manufacturer's fitting instructions for each transmission device.

The motor and transmission device must be aligned accurately, both radially and axially. Any failure to do so will result in erratic operation, damage to bearings and a high level of wear.

4.5. Electrical installation

These motors are not designed to be connected directly to the electrical system.

It is the installer's responsibility to specify the electrical protection to be deployed with regard to the regulations applicable to the field of use of the final product.

For the supply to the power part, we recommend the use of a stabilised double-insulated power supply unit.

The motor's power stage is not protected against reversed polarity.

The motor is said to be regenerative, i.e. it can feed back energy to the power supply during braking phases.

Voltage surges created in this way can reach levels that risk damaging the motor itself or to devices connected to the same power supply.

DANGER

ELECTRIC SHOCK

High voltages can occur unexpectedly at the motor connection.

- The motor produces a voltage when the shaft rotates. Isolate the motor shaft from any external driving force before doing any work on the drive system.
- The system's manufacturer is responsible for complying with all the rules applicable to the earthing of the drive system.

Failure to take these precautions could result in death or serious injury.

WARNING

UNEXPECTED MOVEMENT

Drives may move unexpectedly, due to an incorrect connection or some other error.

- Only start the installation if there is no person or obstacle inside the danger zone.
- Make initial test movements with no load connected.
- Do not touch the motor shaft or connected drive components.

If these precautions are not taken, the result could be death, serious injury or damage to equipment.

 **WARNING****OVER-VOLTAGES**

During braking phases, the motor generates over-voltages.

- Check that these over-voltages are acceptable to other equipment connected to the same power supply.
- Preferably use an external circuit, to limit over-volting

In cases where braking is used intensively.

If these precautions are not taken, the result could be death, serious injury or damage to equipment.

 **CAUTION****FIRE DUE TO POOR CONTACT**

The connection terminals to the motor could heat up and the contacts melt due to electrical arcing, if the connector is not properly plugged in.

- Poor connections can cause heating due to electrical arcing.

If these precautions are not taken, the result could be injury or damage to equipment.

 **CAUTION****REVERSED POLARITY COULD DESTROY THE PRODUCT**

Incorrectly connecting the power can result in reversed polarity and the destruction of the electronic board inside the motor.

- Check that the power connection is correct.

If these precautions are not taken, the result could be injury or damage to equipment.

Connecting the protective conductor

It is the installer's responsibility to determine the necessity to earth the motor.

This must be done via the mounting flange.

Under no circumstances connect or disconnect the product's power supply wires while they are live.

4.5.1. Connecting the holding brake (option)

 WARNING
<p>LOSS OF BRAKING FORCE DUE TO WEAR OR HIGH TEMPERATURE Application of the holding brake while the motor is rotating can cause rapid wear and loss of braking force.</p> <ul style="list-style-type: none">• Do not use the brake as a service brake.• Note that an "emergency stop" can also cause wear. <p>If these precautions are not taken, the result could be death, serious injury or damage to equipment.</p>

 WARNING
<p>UNEXPECTED MOVEMENT Releasing the holding brake can cause unexpected movement in the installation.</p> <ul style="list-style-type: none">• Take care that this does not cause any damage.• Only run tests if there is no person or obstacle inside the danger zone. <p>If these precautions are not taken, the result could be death, serious injury or damage to equipment.</p>

 CAUTION
<p>MALFUNCTION OF THE HOLDING BRAKE DUE TO AN INAPPROPRIATE VOLTAGE</p> <ul style="list-style-type: none">• If the voltage is too low, the holding brake cannot release itself and that will cause wear.• If voltages are higher than specified, the holding brake will suffer excessive heating. <p>If these precautions are not taken, the result could be injury or damage to equipment.</p>

A motor with a holding brake requires a suitable control logic which releases the brake when rotational movement starts and which grips the motor shaft in time when the motor stops.

4.6. Production connector

The motor is fitted with a silicone plug, as shown in the image below. It protects the connector used during the motor's manufacture. This connector is not intended to be accessed by users of the product. If the plug is removed, the motor will no longer be sealed, allowing fluids and particles to enter the motor, potentially destroying it or causing it to malfunction.

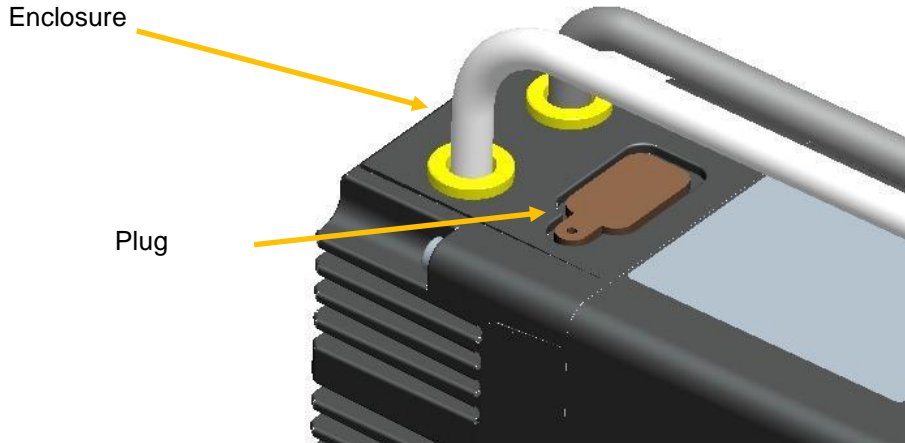

Figure 3

The plug should never be removed by the user.

 **CAUTION**

LOSS OF SEALING

The plug keeps the motor sealed.

- Do not remove the plug.

If these precautions are not taken, the result could be injury or damage to equipment.

5. SWITCHING ON

5.1. Preparations for switching on

Before switching on:

- ⇒ Check that the mechanical installation is correct.
- ⇒ Check that the electrical installation has been done professionally: in particular, check the connections on protective conductors and earth connections. Ensure that all connections are correct and sound and that screws are properly tight.
- ⇒ Check the ambient conditions and conditions for use: ensure that the prescribed ambient conditions are met and that the drive solution complies with the intended conditions for use.
- ⇒ Check that any transmission devices already fitted are balanced and accurately aligned.
- ⇒ Check that the conditions of use do not cause any abnormal over-voltages for the product or the application.
- ⇒ Check that the holding brake can support the maximum load. Check that after the braking voltage is applied, the holding brake releases correctly. Ensure that the holding brake is properly released prior to movement starting.
- ⇒ Check that the connector protection plug is in place.

 **WARNING****UNEXPECTED MOVEMENT**

Drives may move unexpectedly, due to an incorrect connection or some other error.

- Check the wiring.
- Only start the installation if there is no person or obstacle inside the danger zone.
- Make initial test movements with no load coupled.
- Do not touch the motor shaft or associated drive components.

If these precautions are not taken, the result could be death, serious injury or damage to equipment.

 **WARNING****ROTATING PARTS**

Rotating parts can cause injury or catch clothing or hair. Loose parts or unbalanced parts can be thrown off.

- Check that all rotating parts are secure.
- Fit a guard over rotating parts.

If these precautions are not taken, the result could be death, serious injury or damage to equipment.

 **WARNING****FALLING PARTS**

Reactive torque could cause the motor to move, tip or fall.

- Secure the motor firmly, so that it cannot come loose due to severe acceleration.

If these precautions are not taken, the result could be death, serious injury or damage to equipment.

 **CAUTION****HOT SURFACES**

The surface of the motor can reach more than 70°C during use.

- Avoid contact with hot surfaces.
- Do not position inflammable or heat-sensitive components in immediate proximity.
- Try to achieve an assembly that allows heat to dissipate efficiently.
- Run a test to check the temperature.

If these precautions are not taken, the result could be injury or damage to equipment.

 **CAUTION****OVER-VOLTAGES**

During braking phases, the motor generates over-voltages.

- Check that these over-voltages are acceptable to other equipment connected to the same power supply.
- Preferably use an external circuit, to limit over-volting

In cases where braking is used intensively.

If these precautions are not taken, the result could be injury or damage to equipment.

6. PRODUCT PRESENTATION

6.1. Description of the product

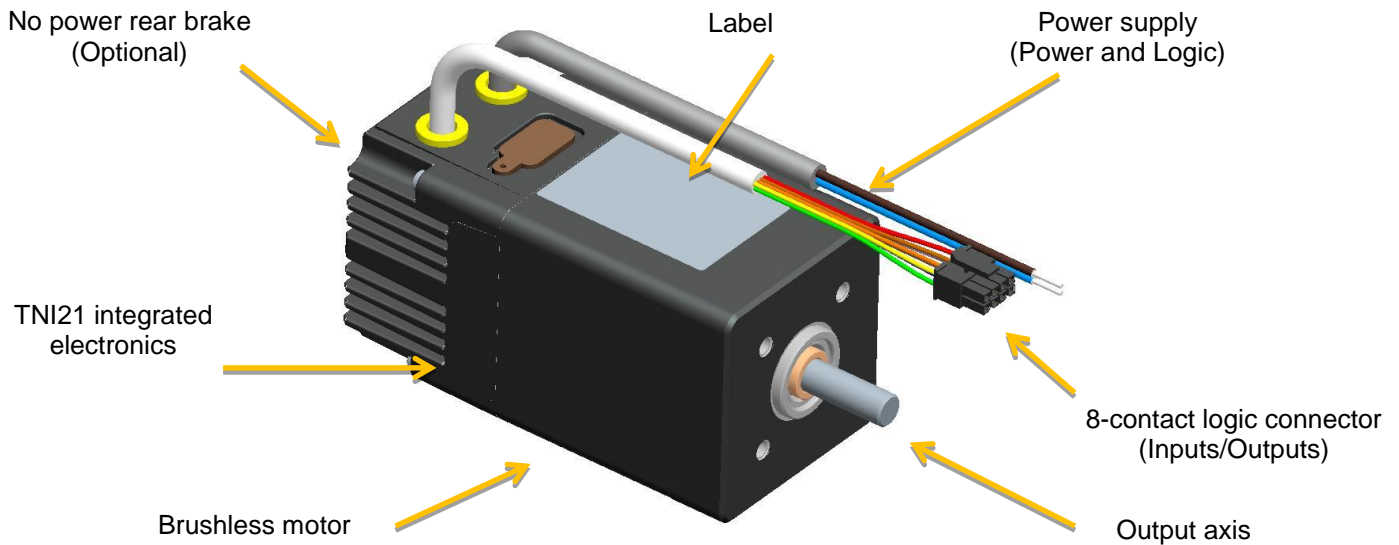

Figure 4

6.2. TNi21 control electronics

The TNi21 electronic board contains control electronics for brushless motors and is built into the body of the motor.

These electronics provide:

- Motor power control in trapeze mode ("6 steps").
- A speed control
- Torque limiting control
- Management of the four inputs and three outputs that control the motor:
 - Two 10-bit or PWM analogue control inputs
 - Speed set-point
 - Torque limiting
 - Two switching inputs
 - On/off
 - Direction of rotation
 - One encoder output
 - 12 points per revolution for 80140 and 80180 motors
 - 24 points per revolution for 80280 motors
 - One 'torque limit reached' switching output
 - One actual direction of rotation switching output

7. TECHNICAL CHARACTERISTICS

7.1. Electrical data

Maximum product characteristics				
Parameters	Value			Unit
Supply voltage V_{DC_MAX}	56 ^(*)			V
Maximum current I_{DC_MAX}	20			A
Maximum voltage at the inputs V_{IN_MAX}	50 ^(*)			V
Maximum voltage at the outputs V_{OUT_MAX}	56 ^(*)			V
Maximum current at the outputs I_{OUT_MAX}	50			mA
Operating characteristics				
Parameters	Min.	Typical	Max.	Unit
Power supply voltage V_{DC}	10	12 / 24 / 32	36	V
Peak current I_{DC}	-	-	17	A
Motor consumption at rest without holding I_0	-	75	-	mA
Input characteristics				
Parameters	Min.	Typical	Max.	Unit
Input impedance between E1 and E2 R_{IN_TOR}	-	57	-	k Ω
Input impedance between E3 and E4 $R_{IN_ANA/PWM}$	-	69	-	k Ω
Low logic level on inputs E1 to E2 V_{IL_TOR}	0	-	2	V
High logic level on inputs E1 to E2 V_{IH_TOR}	4	-	50 ^(*)	V
Low logic level on inputs E3 to E4 V_{IL_PWM}	0	-	2	V
High logic level on inputs E3 to E4 V_{IH_PWM}	7.5	-	50 ^(*)	V
Frequency of PWMs on input	100	-	2000	Hz
Resolution of proportional inputs		10		bits
Output characteristics				
Parameters	Min.	Typical	Max.	Unit
Low logic level on outputs S1 to S3 V_{OL} $R_L = 4K7\Omega, V_{DC} = 24V$	0	-	0.2	V
High logic level on outputs S1 to S3 V_{OL} $R_L = 4K7\Omega, V_{CC} = 24V$	$V_{DC} - 0.5V$	-	V_{DC}	V
Type PNP open slip-ring				

^(*) 36V prior to 15 October 2015

7.2. Generic data

General characteristics		
Parameters	Value	Unit
Motor ambient temperature	-30 to +70	°C
Insulation class (complies with directive IEC 60085)	E	/
Protection index (other than shaft axis)	IP65M	/

7.3. Control logic bundle

Comprises a UL-approved cable, style 2464 80°C 300V, 500mm long as standard, fitted with a Molex connector reference [43025-0800](#) 8 contacts:

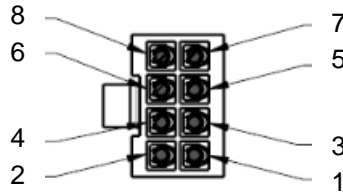

Figure 5

Pin	Function	Colour of wires (AWG24)
1	Input no.1 – On / Off	Vert / Green
2	Input no. 2 – Direction of rotation	Jaune / Yellow
3	Input no. 3 – Torque set-point 0-10V or PWM	Bleu / Blue
4	Input no. 4 – Speed set-point 0-10V or PWM	Orange / Orange
5	Logical earth - 0V DC	Noir / Black
6	Output no. 1 – Encoder 12 or 24 pts per rev	Marron / Brown
7	Output no. 2 – Torque limit reached	Violet / Purple
8	Output no. 3 – Actual direction of rotation	Rouge / Red

a label attached to the motor provides this information:

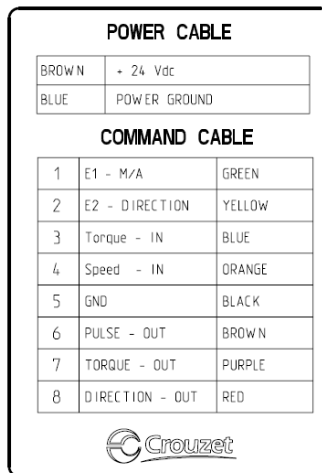

Figure 6

References for the connector to be used:
 On the board: Molex series 43045
 On the cable: Molex series 43020

If the cable is more than 3m long, tests should be conducted in situ.

7.4. Power supply cable

Function	Colour of wires (AWG16)
Power supplied: +12V DC → +32V DC	Marron / <i>Brown</i>
Power earth: 0V DC	Bleu / <i>Blue</i>

The power supply cable is UL-approved style 2517 105°C 300V, 500mm long as standard.

Where a cable extension is used, the cross-section of the cable used must be of sufficient size for the current consumed and the length of cable.

8. MOTOR ELECTRICAL CONNECTION

8.1. Power connection

We recommend that the motor frame is earthed.

Diagram showing power connections.

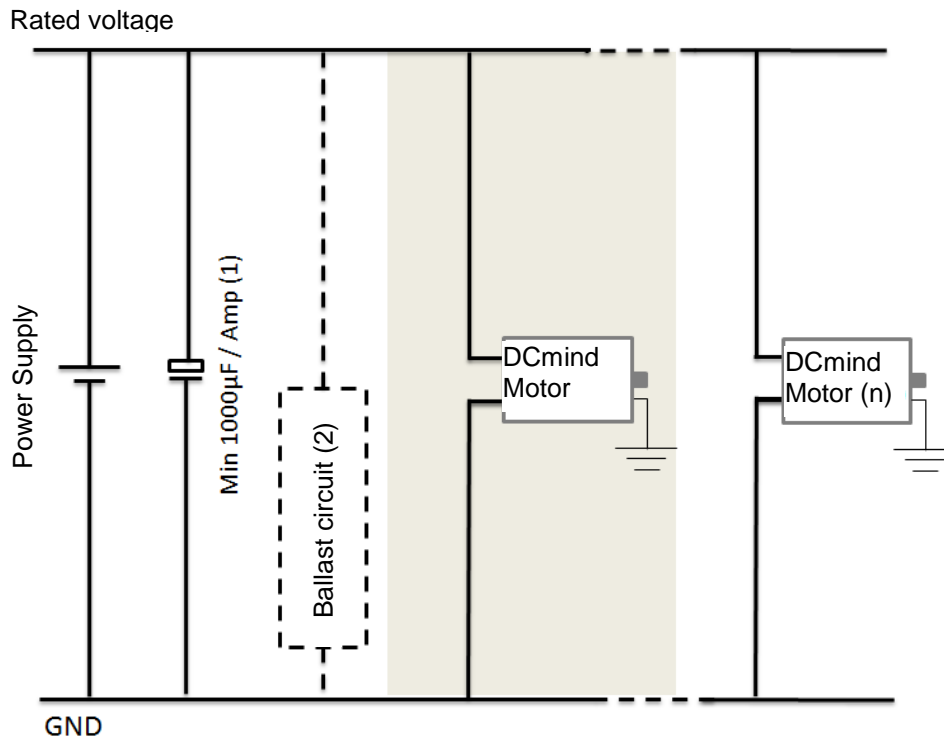



Figure 7

- (1) Fit capacitors to smooth out inrush current. Recommended value 1000 μ F per Amp consumed.
 (2) Optional. The ballast circuit eliminates over-voltages produced during braking. See next section.

 CAUTION
<p>REVERSED POLARITY The product is not protected against reversed polarity in the power cable. Reversing the polarity could damage the product beyond repair.</p>

8.1.1. Ballast circuit

When the motor brakes, the kinetic energy stored in the inertia in rotation is returned to the power supply and generates an over-voltage. This over-voltage can be damaging to the motor or other devices connected to the same power supply.

Where there is frequent braking, **an external ballast circuit should be used.**

In all cases, it is necessary to carry out sizing tests.

Note: upon request, the motor can be supplied with much weaker, non-regenerative braking. In that case, no ballast circuit is required.

8.1.1.1. Proposed ballast circuit diagram.

The arrangement below dissipates braking energy into a resistor, thus limiting the over-voltage at the motor terminals.

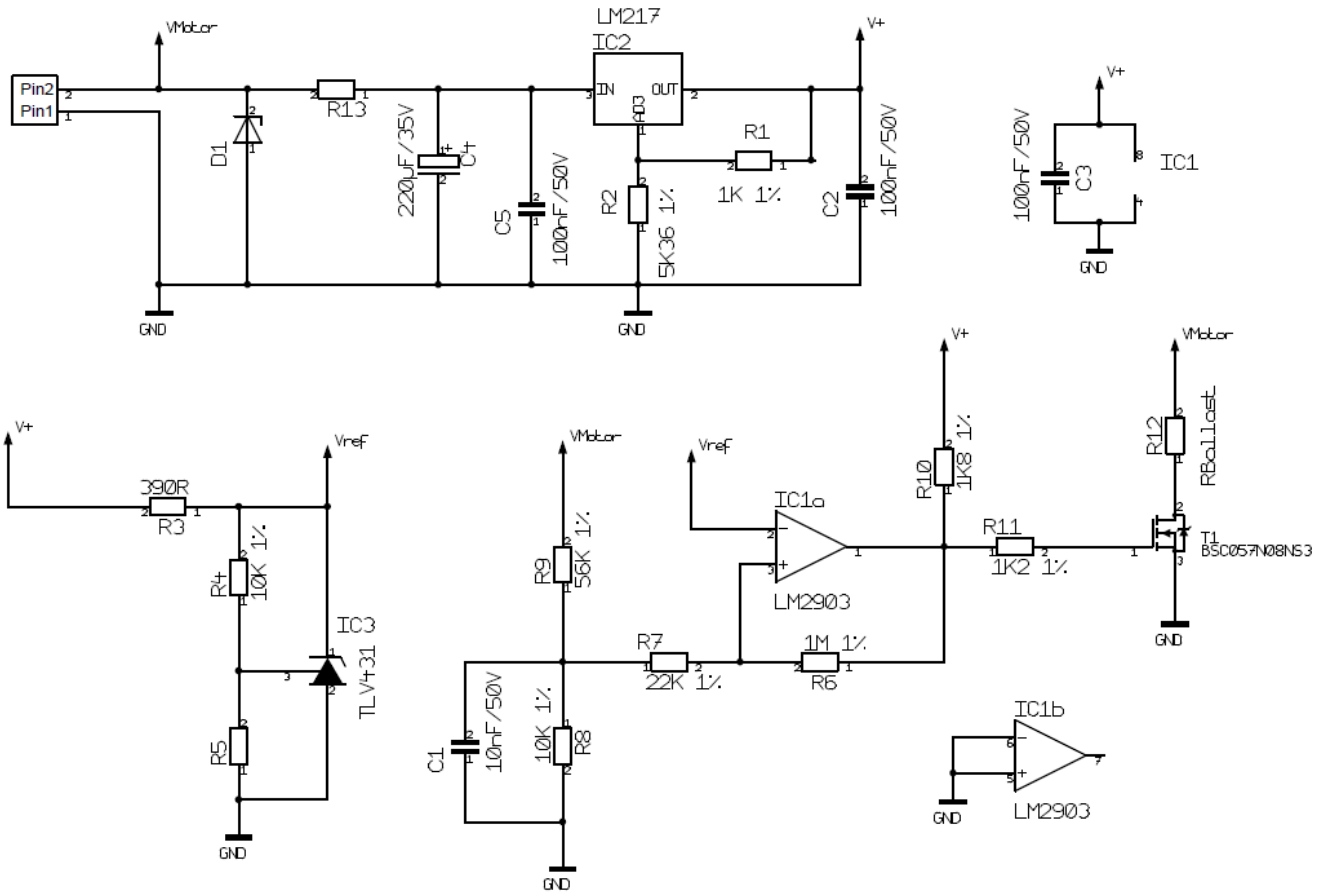

Figure 8

8.1.1.2. Sizing resistor R12 (R_{Ballast})

The lower the resistor value, the higher the braking current. Typical values are in the region of several Ohms. Where V is the speed of rotation in rpm and J the inertia in kg.m². The energy E in Joules stored in the inertia is given by:

$$E = \frac{\pi^2}{1800} \times J \times V^2$$

If t is the braking time in seconds, the power P1 dissipated during that time will be:

$$P1 = \frac{E}{t}$$

Note: Time t is adjusted via the value of the deceleration ramps in the MMI.

If T is the time interval between two braking instances in seconds, the average power dissipated, P2, will be:

$$P2 = \frac{P1}{T}$$

The resistor must be sized to dissipate power P2 while accepting the peaks at P1.

It should be noted, however, that this calculation is simplified and pessimistic, since it does not take into consideration the energy stored in the capacitors nor that lost in friction, the gearbox, etc.

8.1.1.3. Selecting the cut-off voltage

The cut-off voltage should be selected:

- According to the power supply
- According to other devices connected to the same power supply.

If your power supply does not tolerate current feedback, fit a diode in series upstream of the ballast circuit to protect it.

A typical cut-off voltage would be between +10% and +20% of the supply voltage.

Example: For 24V DC the cut-off voltage would be 28V DC

List of components for typical operating voltages:

Rated voltage	12V	24V	32V
Cut-off voltage	14V	28V	36V
D1	SMBJ14A	SMBJ28A	SMBJ36A
R13	0R	560R 0.5W	1K 1W
R5	15K 1%	4K32 1%	3K09 1%

8.1.2. Protection for EMC

To ensure that the product is compatible with EMC standards IEC 61000-6-1, IEC 61000-6-2, IEC 61000-6-3 and IEC 61000-6-4.

We recommend:

- Earthing the motor with the shortest possible length of earth braid.
- For conducted emissions with an unstabilised power supply, add a capacitor based filter and common mode choke to the main power supply (see filter structure example below):

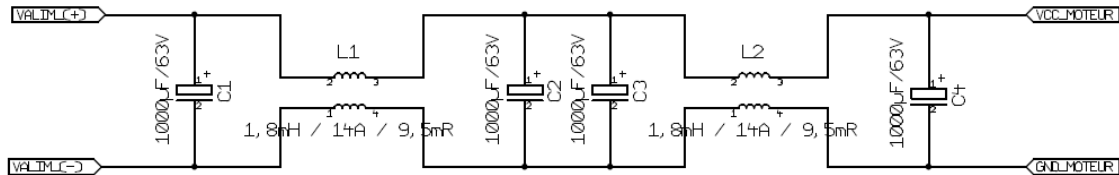

Component list for the above filter:

	Reference	Manufacturer	Characteristics
C1 to C4	/	/	1000µF / 63V / polarised
L1 and L2	744 826 141 8	WE	1.8mH / 14A / 9.5mΩ

8.2. Protective devices

DANGER

PROTECTIVE DEVICES

The product includes internal protection devices which cut the power supply to the motor, when activated. Since the motor is no longer being controlled, driving forces may drop.

- The manufacturer of the system is responsible for complying with all the safety rules applicable in the event of product failure.

Failure to take these precautions could result in death or serious injury.

CAUTION

OVER-VOLTAGES

Exceeding the maximum recommended power supply threshold will result in the product being destroyed.

- Check the motor's supply voltage before connecting it.

If these precautions are not taken, the result could be injury or damage to equipment.

8.2.1. Voltage protection

The product has protection against over and under-voltages.

Protection against over-voltages:

The over-voltage threshold is set to 56V^(*).

When the power supply voltage exceeds the threshold, the product automatically goes into SAFE mode: power to the motor is then cut and it is no longer controlled.

To reset the motor, it is necessary:

- That the supply voltage is lower than 56V^(*)
- The motor inputs are in OFF mode.

Protection against under-voltages:

When the power supply voltage drops below 9V, the product automatically switches to SAFE mode: power to the motor is then cut and it is no longer controlled.

To reset the motor, it is necessary:

- That the supply voltage is greater than 10V
- The motor's On / Off input is in OFF mode.

^(*) 36V prior to 15 October 2015

8.2.2. Temperature protection

The product includes temperature protection via a temperature sensor on the motor control board.

Temperature protection:

When the internal temperature exceeds 110°C, the product automatically switches to SAFE mode: power to the motor is then cut and it is no longer controlled.

To reset the motor, it is necessary that:

- The temperature is below 90°.
- The motor's On / Off input is in OFF mode.

8.2.3. Current limiting

The product has an internal current limiter. This limiter operates directly on the motor through hardware. The limiter automatically clips the current to the peak current value in the motor phases. If the limit is reached, the motor's performance is reduced. This product is not designed to operate continuously at this limit (see the "Electrical data" section).

8.3. Connecting inputs/outputs

8.3.1. Equivalent inputs diagram

NPN digital inputs: "ON/OFF" and "Direction of rotation"

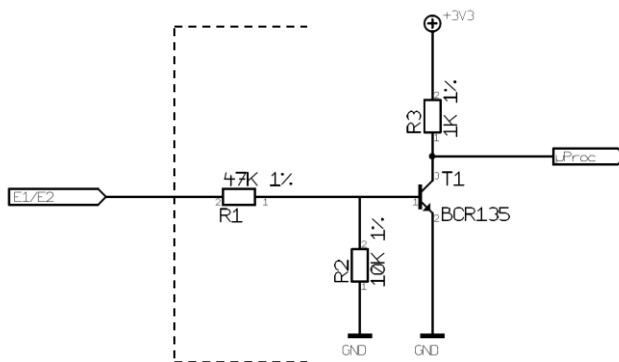

Figure 9

Analogue inputs / PWM: "Speed set-point" and "Torque set-point"

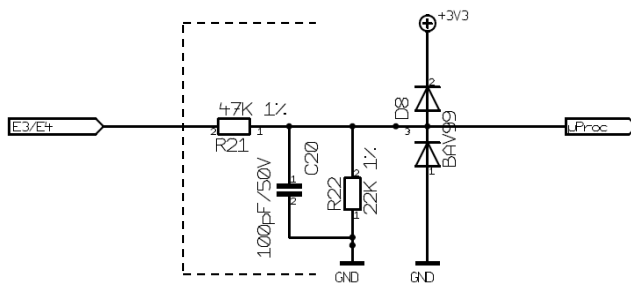

Figure 10

8.3.2. Equivalent outputs diagram

PNP outputs to 50mA max. open slip-ring
Fit a pull-down resistor (recommended value 4.7 kΩ).

! CAUTION

EARTHING THE OUTPUTS
The accidental earthing of the outputs or connecting them to a capacitive load will result in them being destroyed.
Before powering up the motor, check that the outputs are wired correctly.
If these precautions are not taken, the result could be injury or damage to equipment.

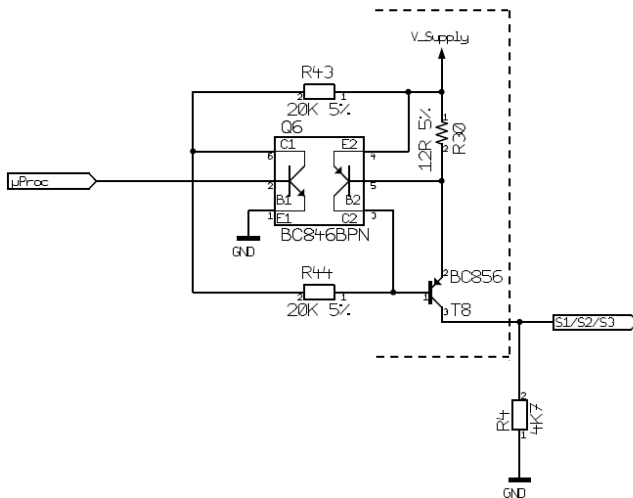

Figure 11

Caution: the output level is equal to the motor's supply voltage:

if V DC = 32V then S1 / S2 / S3 = 32V.

If there is rejection, the voltage increases as a result; it may rise to the maximum of 56V (over-voltage threshold value).

If, for your application, it is necessary to limit the voltage at these outputs, you should make the following arrangement.

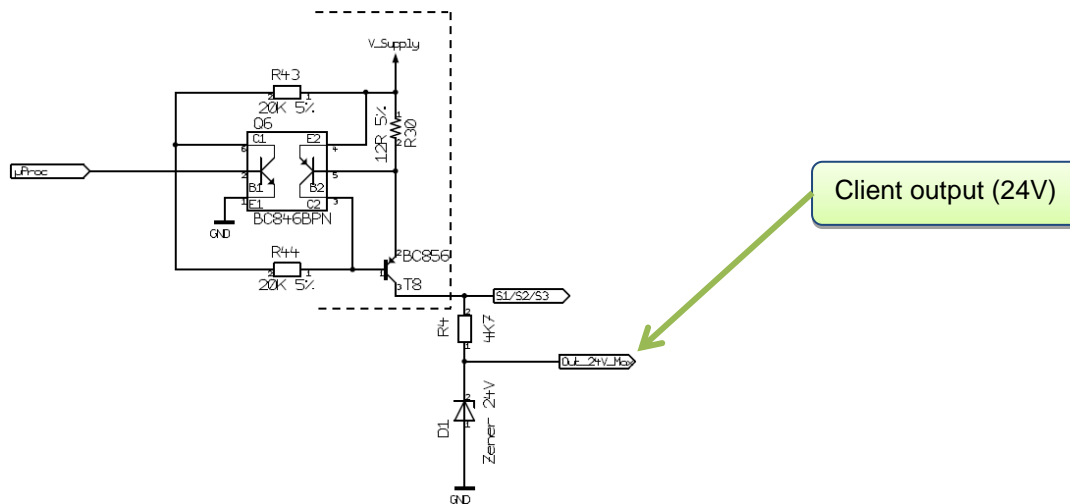

Figure 12

9. OPERATING MODE

9.1. Preliminaries

DCmind motors with TNI21 integrated electronics are designed to operate by regulating the speed with an adjustable torque limiter.

These electronics operate in trapezoidal switching mode.

There are two types of board available in the catalogue:

- Version with proportional 0-10V inputs
- Version with proportional PWM inputs

The speed is controlled by a factory-set PID to allow a wider operating range. The torque supplied by the motor is automatically limited internally.

9.2. Functions associated with inputs

9.2.1. Function E1 - On / Off

State	Function
0	De-activates the power
1	Activates the power

State 0 corresponds to the motor's OFF mode.

State 1 corresponds to the motor's ON mode.

Changing to 1 activates the power: speed regulation (as per the set-point applied to E3, in 0-10V or PWM) with torque limiting (as per the set-point applied to E4, in 0-10V or WM).

Changing to 0 cuts the power, following the speed profile (deceleration ramp).

9.2.2. Function E2 - Direction of rotation

State	Function
0	Anti-clockwise rotation (SI)
1	Clockwise rotation (SA)

If the motor is rotating, the direction is reversed:

- Instantly if the speed is less than 1000 rpm
- Via a controlled slow-down phase until the speed reaches 1000 rpm.

9.2.3. Function E3 - Speed set-point

The speed set-point proportional input operates in the range 70 to 4000 rpm.

Starting hysteresis set to 70 rpm.

Stopping hysteresis set to 35 rpm.

Below these values, the speed set-point is considered as zero.

This input operates either on 0-10V or PWM, depending on the product ordered.

9.2.4. Function E4 - Torque limiter set-point

The torque limiter proportional input is linear throughout its range.
The corresponding scale varies according to the type of motor:

Drive basis	Min terminal (0V or 0%)	Max terminal (10V or 100%)
80140_TNi21	360 mN.m	35 mN.m
80180_TNi21	700 mN.m	35 mN.m
80280_TNi21	1000 mN.m	100 mN.m

This input operates either on 0-10V or PWM, depending on the product ordered.

9.3. Functions associated with outputs

All outputs are open slip-ring PNP.

The voltage delivered by these outputs is V DC (power supply voltage)

9.3.1. Function S1 - Encoder output

A fixed width top hall (500µs) is generated each time that one of the motor's three hall sensors changes state.

Motors 80140_TNi21 and 80180_TNi21 have twelve top halls per motor revolution (two pairs of poles).
Motor 80280_TNi21 has 24 top halls per motor revolution (four pairs of poles).

The rest state of output S1 is 0. The calibrated pulse is positive (set to V DC)

9.3.2. Function S2 - Torque limiter output

Output S2 gives information on the motor's torque limiter:

If S2 = 0V (output at low state) → Normal operation
If S2 = V_{CC} (output at high state) → Torque limit reached

9.3.3. Function S3 - Actual direction of rotation output

Output S3 gives the actual direction of rotation of the motor shaft:

If S3 = 0V (output at low state) → Rotation in reverse direction (SI)
If S3 = V_{DC} (output at high state) → Rotation in forward direction (SA)

9.4. SAFE mode

Motors with TNi21 integrated electronics have a SAFE mode.
If power to the motor is cut, no holding torque is applied (free shaft)

SAFETY	Range limit	Action
Excessive temperature	110°C Stop 90°C OK to run	Re-start necessary
Under-voltage	9V Stop 10V OK to run	Re-start necessary
Over-voltage	36V Stop 35V OK to run	Re-start necessary

Motor re-start procedure following the detection of an error:

- To resolve the cause of a fault.
- Move to off mode: deactivate "On / Off" digital input no. 1
- Return to on mode: activate "On / Off" digital input no. 1

10. DIAGNOSTICS AND TROUBLESHOOTING

10.1. Mechanical faults

Error	Cause	Resolving the fault
Excessive heating	Overload Holding brake not released	Reduce the load Check the holding brake control
Whistling or knocking	Defective bearings	Contact after-sales
Friction noises	A rotating transmission component is rubbing	Align the transmission component
Radial vibration	Transmission component not sufficiently accurately aligned Transmission component out of balance Twisted shaft Resonance in the mounting	Align the transmission component Balance the transmission component Contact after-sales Check the rigidity of the motor mounting
Axial vibration	Transmission part not sufficiently accurately aligned Impact on the transmission component Resonance in the mounting	Align the transmission component Check the transmission component Check the rigidity of the motor mounting

10.2. Electrical problems

Error	Cause	Resolving the fault
The motor does not start or is difficult to start	Overload Fault in connection wires Inadequate power supply	Reduce the load Check the connecting wires Check the power supply Contact after-sales
Significant heating of the stator	Overload	Reduce the load
Heating at the connection terminals	Loose or poorly tightened power supply wires	Re-tighten the screws

11. SERVICE, MAINTENANCE AND PROBLEM SOLVING

11.1. Addresses of after-sales service points

Contact your distributor

The list of distributors can be accessed via the Crouzet Automatismes web site www.crouzet.com

11.2. Storage

Motors should only be transported and stored in a dry environment, free from dust and protected from vibration.

The ambient conditions are stated in the product's data sheet and should be complied with.

Storage time is essentially dictated by the stability of the lubricants and should be less than 36 months.

To maintain it in operating condition, occasional running of the drive solution is recommended.

11.3. Maintenance

Only the manufacturer is authorised to carry out repairs. Any work done by unauthorised persons will nullify the manufacturer's warranty and liability.

Repairing the motor when fitted is not possible.

Before doing any work on the drive system, please consult the *Installation and Switching on* section, to find out what measures to take.

We recommend that the following is done at regular intervals with the power switched off.

Connections and mounting

=> Check all cables and connections regularly for signs of damage. Replace any damaged cables immediately.

=> Check that all transmission components are properly secure.

=> Re-tighten all mechanical and electrical bolted assemblies to the appropriate torque.



WARNING

UNEXPECTED MOVEMENT

In the event that the permitted ambient conditions are not maintained, foreign bodies from the surrounding area may enter and cause unexpected movement or damage to equipment.

- Check the ambient conditions.
- Fluids should not be allowed to stagnate in the shaft bushing.

If these precautions are not taken, the result could be death, serious injury or damage to equipment.

Cleaning

Remove dust and dirt from the motor regularly. Insufficient dissipation of heat into the atmosphere may cause abnormally high temperatures.

Motors are not designed to be cleaned with a high pressure cleaner. A high pressure could cause water to enter the motor's interior.

If cleaning products or solvents are used, care should be taken not to damage the motor's power supply wires and any options (brake), ball bearings or the finish on the motor.

Check / bed in the holding brake

Occasional braking with a moved load will help to maintain the holding brake's holding torque. If the holding brake is not called upon to do any mechanical work for a long period (braking with a moved load), some of its parts could corrode or deposits might accumulate and so reduce its holding power.

The holding brake is bedded in before it leaves the factory. If the holding brake is not called upon to do any mechanical work for a long period, some of its parts could corrode. If the holding brake does not provide the holding torque specified in its technical characteristics, it might be necessary to bed it in again.

=> Dismount the motor. Close the holding brake.

=> Measure the torque from the holding brake, using a dynamometer.

=> Compare the reading with the holding torque stated in the data sheet.

=> If the holding torque differs appreciably from the values stated, turn the motor shaft by hand 25 revolutions in both directions.

=> Repeat the operation. If, after three repetitions, the holding torque is not re-established, please contact your dealer.

11.4. Replacing the motor

=> Disconnect all sources of power. Ensure that no power is still being applied (safety instructions).

=> Identify all connections and dismount the product.

=> Replace it with a motor with the same reference.

=> Install the new product in accordance with chapter 4 "Installation".

=> Carry out commissioning in accordance with chapter 5 "Commissioning".

11.5. Shipping, storage, disposal

Comply with the ambient conditions stated in the "TECHNICAL CHARACTERISTICS" chapter.

Shipping

Always protect the product against impacts when shipping it.

For this, use the original packing.

Storage

Only store the product under the permissible ambient temperature and humidity conditions specified.

Protect the product from dust and dirt.

Disposal

The product comprises various materials that can be re-used or which are subject to selective recycling.

Dispose of any product in accordance with local requirements.

11.6. Terms and abbreviations

Level of protection

The level of protection is a standardised rating used for electrical equipment and intended to describe the protection against the ingress of solids and liquids into the motor enclosure, e.g. IP54M. The M indicates that testing was done with the motor running.

The value does not take into consideration sealing around the output shaft, which must be taken into consideration by the installer.

Axial forces

Tension or compression forces acting on the shaft in a longitudinal direction.

Radial forces

Forces acting on the shaft in a radial direction.

Direction of rotation

Positive or negative direction of rotation of the motor shaft. A positive direction of rotation is clockwise rotation of the shaft when looking at the motor from the output shaft side.

Rated speed

Speed of rotation of the motor when the nominal torque is applied.

Rated current

Current drawn by the motor when the nominal torque is applied.

Nominal torque

The maximum applicable torque on the motor shaft during continuous operation.

Abbreviations in common use:

TNi21:	Commercial name for the new range of electronics for the CROUZET DCmind brushless range.
TOR (switching):	Type of digital input / output (On / off)
PWM:	Pulse Width Modulation
SA:	Clockwise
SI:	Anti-clockwise
EMC:	Electromagnetic compatibility