

**KEMET Part Number: T491D476M025ZG** **Obsolete**  
(B45198H5476M409)

B45198H, Tantalum, MnO2 Tantalum, 47 uF, 20%, 25 V, SMD, Molded, 7343, Height Max = 3.1mm

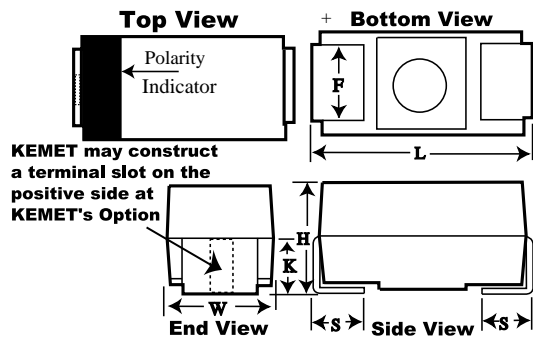

General Information	
Supplier:	KEMET
Series:	B45198H
Dielectric:	MnO2 Tantalum
Style:	SMD Chip
Description:	SMD, Molded
RoHS:	Yes
Termination:	Gold
Notes:	Old Part Number [Obsolete] Was B45198H5476M409

Dimensions	
Footprint	7343
L	7.3mm +/-0.3mm
W	4.3mm +/-0.3mm
H	2.8mm +/-0.3mm
S	1.3mm +/-0.3mm
F	2.4mm +/-0.1mm
K	1.8mm TYP

Specifications	
Capacitance:	47 uF
Capacitance Tolerance:	20%
Voltage DC:	25 VDC (85C), 16.75 VDC (125C)
Temperature Range:	-55/+125C
Rated Temperature:	85C
Dissipation Factor:	6%
Failure Rate:	N/A
Leakage Current:	12 uA

Packaging Specifications	
Packaging:	T&R, 178mm
Packaging Quantity:	750