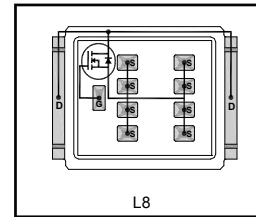

DirectFET™ Power MOSFET

Typical values (unless otherwise specified)

V_{DS}	V_{GS}	$R_{DS(on)}$
100V min	±20V max	2.8mΩ @ 10V
$Q_{g\ tot}$	Q_{gd}	$V_{gs(th)}$
200nC	110nC	2.7V

Applications

- [RoHS Compliant, Halogen Free](#) ②
- [Lead-Free \(Qualified up to 260°C Reflow\)](#) ①
- Ideal for High Performance Isolated Converter Primary Switch Socket
- Optimized for Synchronous Rectification
- Low Conduction Losses
- High Cdv/dt Immunity
- Low Profile (<0.7mm)
- [Dual Sided Cooling Compatible](#) ①
- [Compatible with existing Surface Mount Techniques](#) ①
- Industrial Qualified

[Applicable DirectFET Outline and Substrate Outline](#) ①

SB	SC		M2	M4		L4	L6	L8
----	----	--	----	----	--	----	----	-----------

Description

The IRF7769L1TRPbF combines the latest HEXFET® Power MOSFET Silicon technology with the advanced DirectFET™ packaging to achieve the lowest on-state resistance in a package that has a footprint smaller than a D2PAK and only 0.7 mm profile. The DirectFET™ package is compatible with existing layout geometries used in power applications, PCB assembly equipment and vapor phase, infra-red or convection soldering techniques, when application note [AN-1035](#) is followed regarding the manufacturing methods and processes. The DirectFET™ package allows dual sided cooling to maximize thermal transfer in power systems.

The IRF7769L1TRPbF is optimized for high frequency switching and synchronous rectification applications. The reduced total losses in the device coupled with the high level of thermal performance enables high efficiency and low temperatures, which are key for system reliability improvements, and makes this device ideal for high performance power converters.

Ordering Information

Part number	Package Type	Standard Pack		Note
		Form	Quantity	
IRF7769L1TRPbF	DirectFET Large Can	Tape and Reel	4000	"TR" suffix

Absolute Maximum Ratings

	Parameter	Max.	Units
V_{DS}	Drain-to-Source Voltage	100	V
V_{GS}	Gate-to-Source Voltage	±20	
$I_D @ T_C = 25^\circ C$	Continuous Drain Current, $V_{GS} @ 10V$ (Silicon Limited) ④	124	A
$I_D @ T_C = 100^\circ C$	Continuous Drain Current, $V_{GS} @ 10V$ (Silicon Limited) ④	88	
$I_D @ T_A = 25^\circ C$	Continuous Drain Current, $V_{GS} @ 10V$ (Silicon Limited) ③	20	
$I_D @ T_C = 25^\circ C$	Continuous Drain Current, $V_{GS} @ 10V$ (Package Limited) ④	375	
I_{DM}	Pulsed Drain Current ⑤	500	
E_{AS}	Single Pulse Avalanche Energy ⑥	260	mJ
I_{AR}	Avalanche Current ⑤	74	A

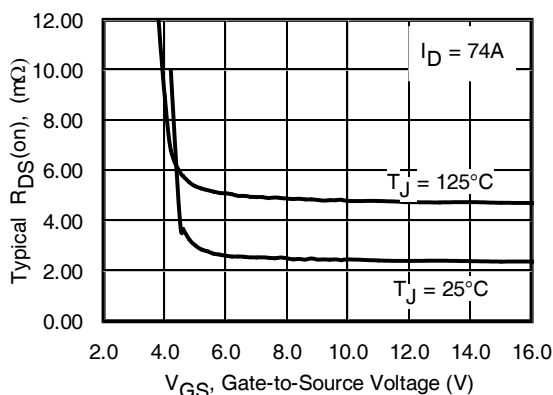
Fig 1. Typical On-Resistance vs. Gate Voltage

Notes

- ① Click on this section to link to the appropriate technical paper.
- ② Click on this section to link to the DirectFET Website.
- ③ Surface mounted on 1 in. square Cu board, steady state.

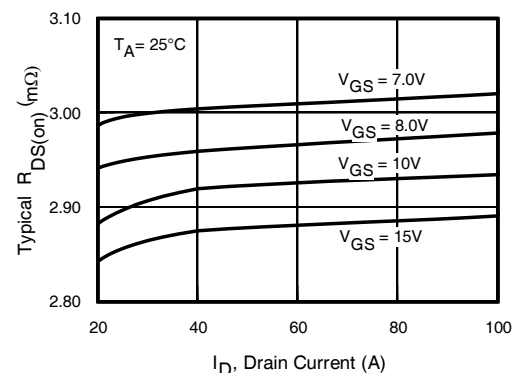
Fig 2. Typical On-Resistance vs. Drain Current

- ④ TC measured with thermocouple mounted to top (Drain) of part.
- ⑤ Repetitive rating; pulse width limited by max. junction temperature.
- ⑥ Starting $T_J = 25^\circ C$, $L = 0.09mH$, $R_G = 25\Omega$, $I_{AS} = 74A$.

Static @ T_J = 25°C (unless otherwise specified)

	Parameter	Min.	Typ.	Max.	Units	Conditions
BV _{DSS}	Drain-to-Source Breakdown Voltage	100	—	—	V	V _{GS} = 0V, I _D = 250μA
ΔBV _{DSS} /ΔT _J	Breakdown Voltage Temp. Coefficient	—	0.02	—	V/°C	Reference to 25°C, I _D = 2mA
R _{DS(on)}	Static Drain-to-Source On-Resistance	—	2.8	3.5	mΩ	V _{GS} = 10V, I _D = 74A
V _{GS(th)}	Gate Threshold Voltage	2.0	2.7	4.0	V	V _{DS} = V _{GS} , I _D = 250μA
ΔV _{GS(th)} /ΔT _J	Gate Threshold Voltage Temp. Coefficient	—	-10	—	mV/°C	
I _{DSS}	Drain-to-Source Leakage Current	—	—	20	μA	V _{DS} = 100 V, V _{GS} = 0V
		—	—	250		V _{DS} = 80V, V _{GS} = 0V, T _J = 125°C
I _{GSS}	Gate-to-Source Forward Leakage	—	—	100	nA	V _{GS} = 20V
	Gate-to-Source Reverse Leakage	—	—	-100		V _{GS} = -20V
g _{fs}	Forward Transconductance	410	—	—	S	V _{DS} = 25V, I _D = 74A
Q _g	Total Gate Charge	—	200	300	nC	V _{DS} = 50V V _{GS} = 10V I _D = 74A See Fig.9
Q _{gs1}	Pre- V _{th} Gate-to-Source Charge	—	30	—		
Q _{gs2}	Post- V _{th} Gate-to-Source Charge	—	9.0	—		
Q _{gd}	Gate-to-Drain Charge	—	110	165		
Q _{godr}	Gate Charge Overdrive	—	51	—		
Q _{sw}	Switch Charge (Q _{gs2} + Q _{gd})	—	119	—		
Q _{oss}	Output Charge	—	53	—	nC	V _{DS} = 16V, V _{GS} = 0V
R _G	Gate Resistance	—	1.5	—	Ω	
t _{d(on)}	Turn-On Delay Time	—	44	—	ns	V _{DD} = 50V, V _{GS} = 10V [Ⓣ] I _D = 74A R _G = 1.8Ω
t _r	Rise Time	—	32	—		
t _{d(off)}	Turn-Off Delay Time	—	92	—		
t _f	Fall Time	—	41	—		
C _{iss}	Input Capacitance	—	11560	—	pF	V _{GS} = 0V V _{DS} = 25V f = 1.0MHz V _{GS} =0V, V _{DS} = 1.0V, f = 1.0MHz V _{GS} =0V, V _{DS} = 80V, f = 1.0MHz
C _{oss}	Output Capacitance	—	1240	—		
C _{rss}	Reverse Transfer Capacitance	—	590	—		
C _{oss}	Output Capacitance	—	6665	—		
C _{oss}	Output Capacitance	—	690	—		

Diode Characteristics

	Parameter	Min.	Typ.	Max.	Units	Conditions
I _S	Continuous Source Current (Body Diode)	—	—	124	A	MOSFET symbol showing the integral reverse p-n junction diode.
I _{SM}	Pulsed Source Current (Body Diode) [Ⓢ]	—	—	500		
V _{SD}	Diode Forward Voltage	—	—	1.3	V	T _J = 25°C, I _S = 74A, V _{GS} = 0V [Ⓣ]
t _{rr}	Reverse Recovery Time	—	75	112	ns	T _J = 25°C, I _F = 74A, V _{DD} = 50V di/dt = 100A/μs [Ⓣ]
Q _{rr}	Reverse Recovery Charge	—	220	330	nC	

Notes:
[Ⓢ] Repetitive rating; pulse width limited by max. junction temperature.

[Ⓣ] Pulse width ≤ 400μs; duty cycle ≤ 2%

Absolute Maximum Ratings

Symbol	Parameter	Max.	Units
$P_D @ T_C = 25^\circ\text{C}$	Power Dissipation ④	125	W
$P_D @ T_C = 100^\circ\text{C}$	Power Dissipation ④	63	
$P_D @ T_A = 25^\circ\text{C}$	Power Dissipation ③	3.3	
T_P	Peak Soldering Temperature	270	°C
T_J	Operating Junction and	-55 to + 175	
T_{STG}	Storage Temperature Range		

Thermal Resistance

Symbol	Parameter	Typ.	Max.	Units
R_{qJA}	Junction-to-Ambient ③	—	45	°C/W
R_{qJA}	Junction-to-Ambient ⑧	12.5	—	
R_{qJA}	Junction-to-Ambient ⑨	20	—	
R_{qJC}	Junction-to-Can ④⑩	—	1.2	
$R_{qJA-PCB}$	Junction-to-PCB Mounted	—	0.4	

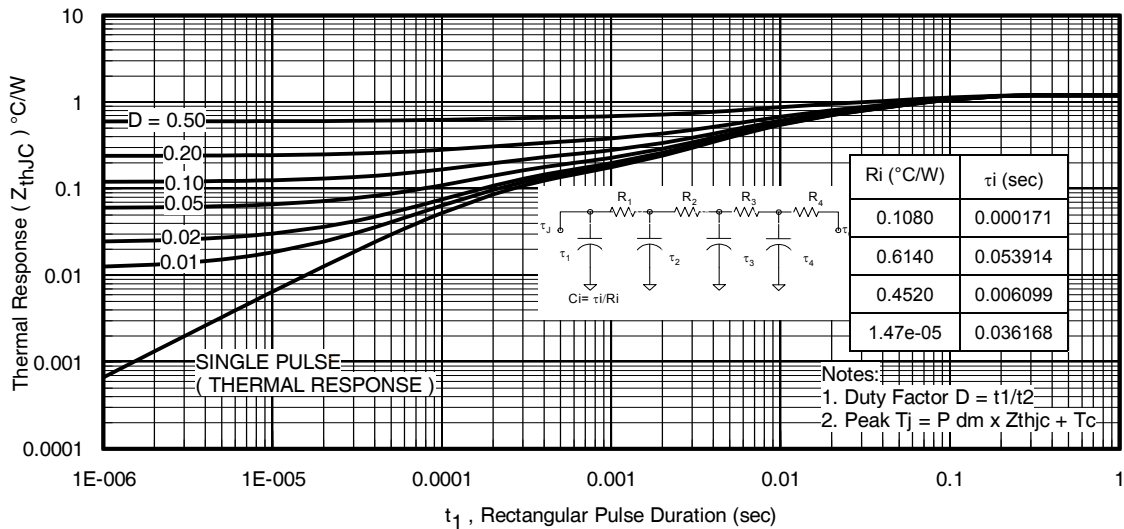
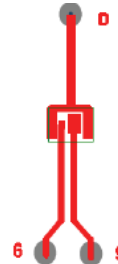
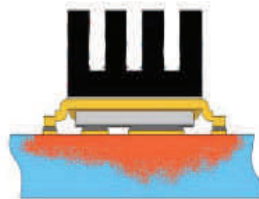
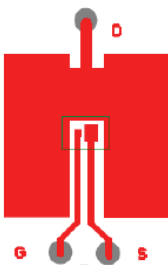

Fig 3. Maximum Effective Transient Thermal Impedance, Junction-to-Case

Notes:

- ③ Surface mounted on 1 in. square Cu board, steady state.
- ④ T_C measured with thermocouple incontact with top (Drain) of part.
- ⑤ Repetitive rating; pulse width limited by max. junction temperature.
- ⑧ Used double sided cooling, mounting pad with large heatsink.
- ⑨ Mounted on minimum footprint full size board with metalized back and with small clip heatsink.
- ⑩ R_{θ} is measured at T_J of approximately 90°C.



③ Surface mounted on 1 in. square Cu board (still air).

⑨ Mounted on minimum footprint full size board with metalized back and with small clip heatsink (still air)

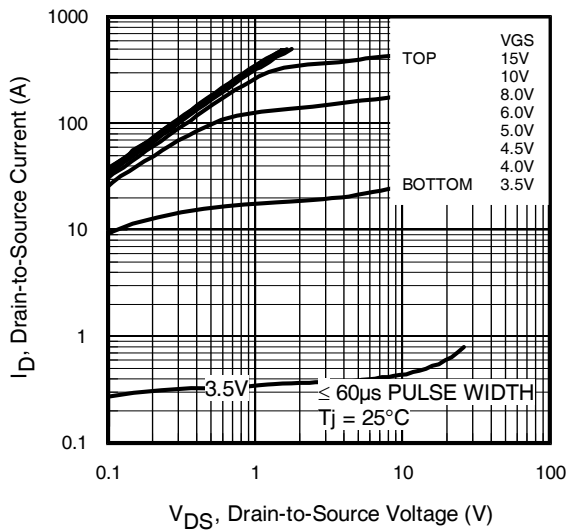
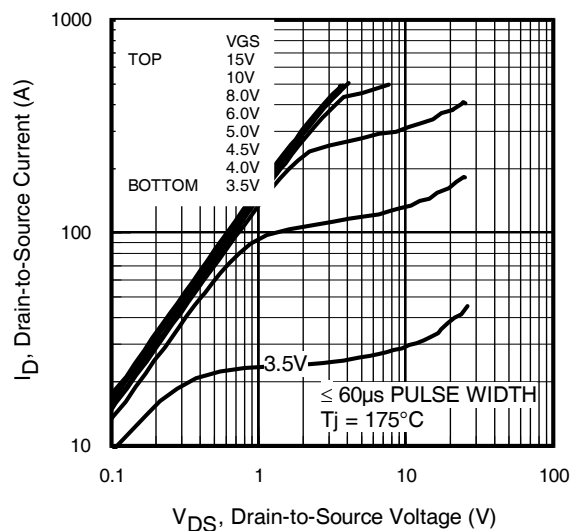
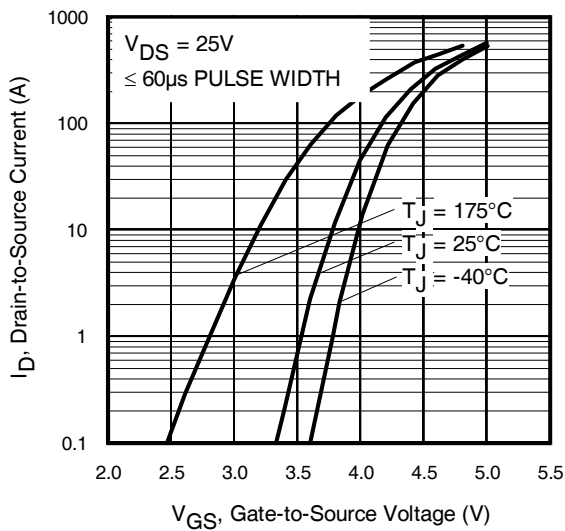
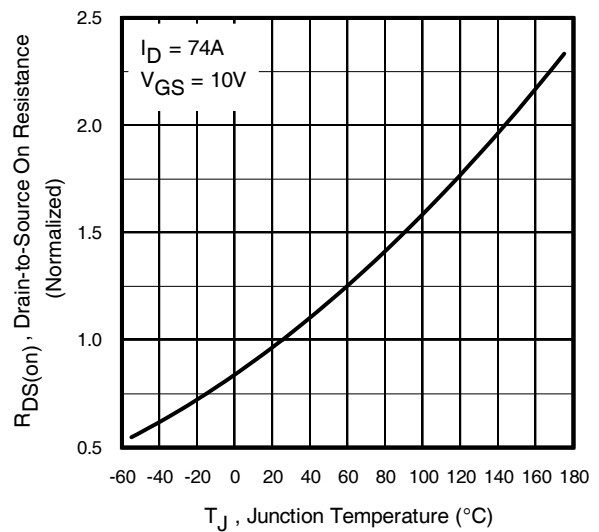
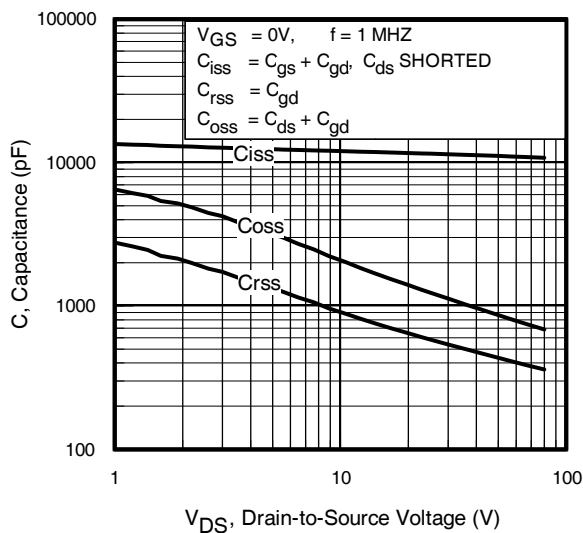
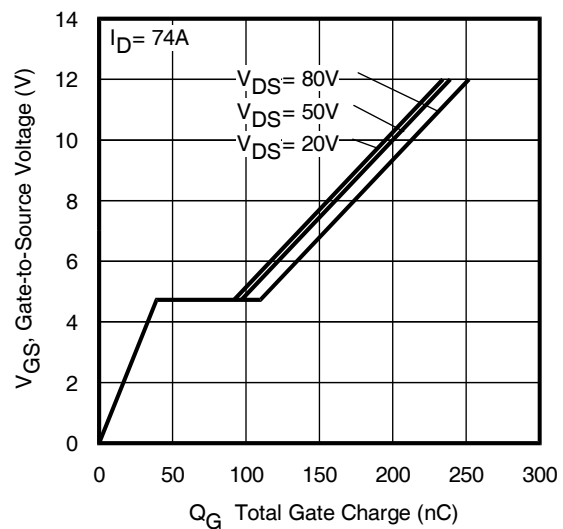
Fig 4. Typical Output Characteristics

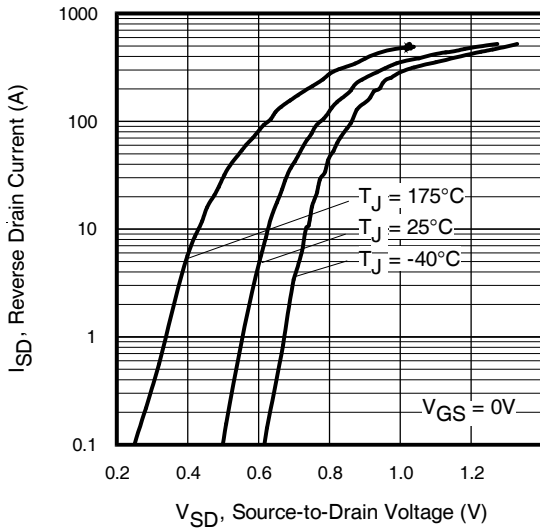
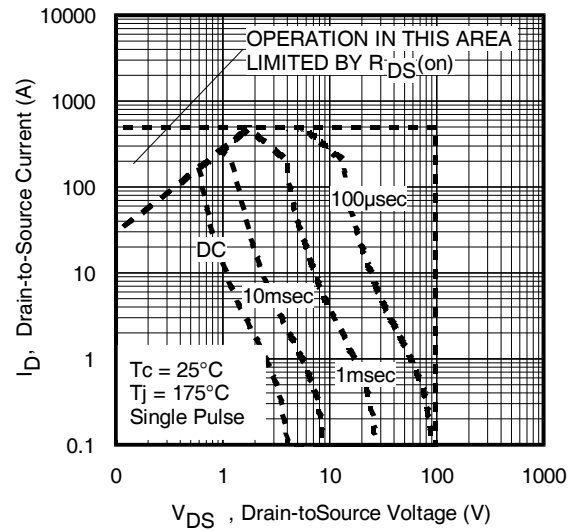
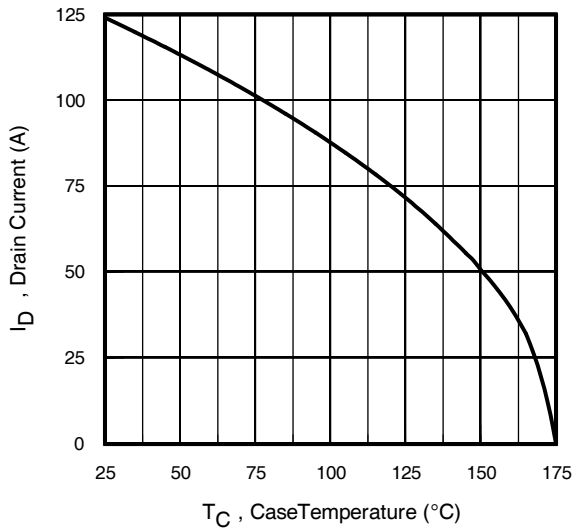
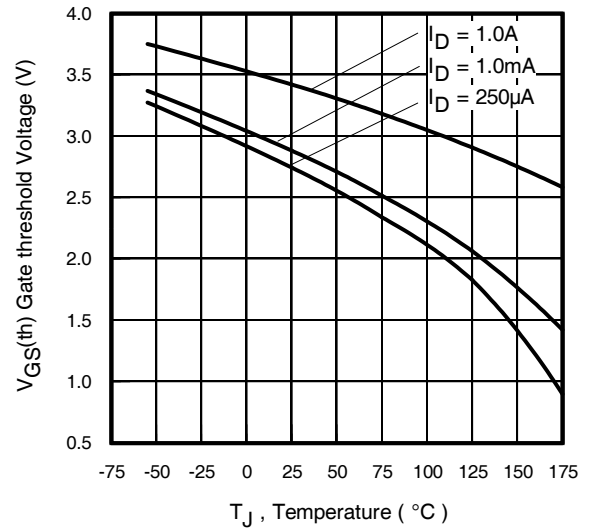
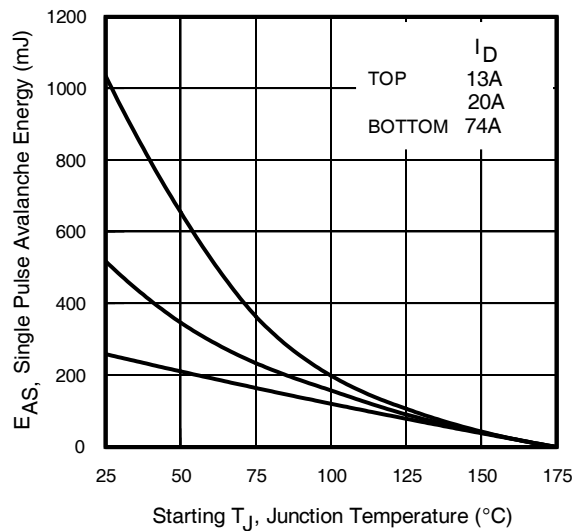
Fig 5. Typical Output Characteristics

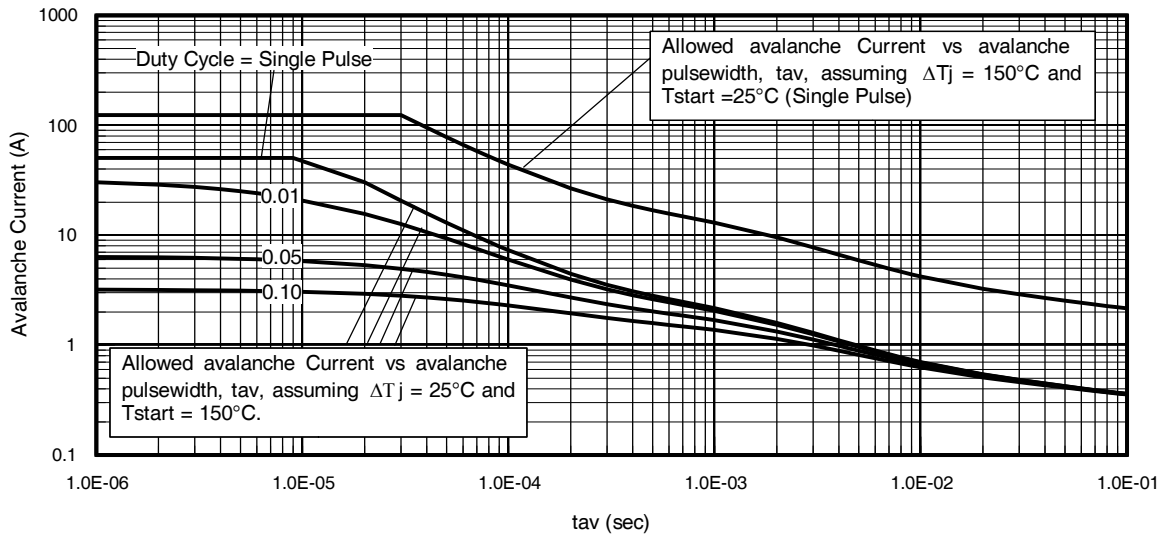
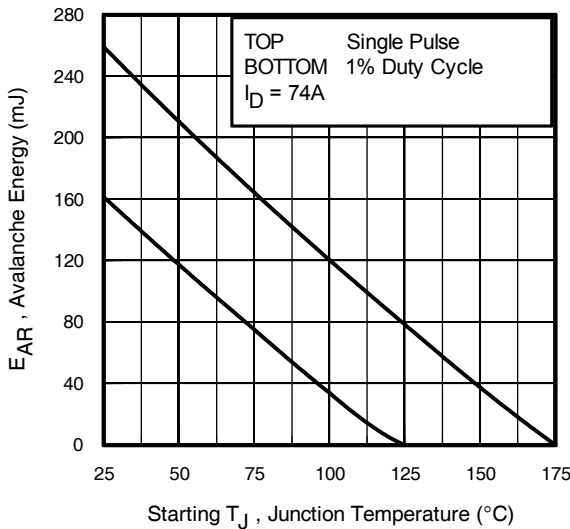
Fig 6. Typical Transfer Characteristics

Fig 7. Normalized On-Resistance vs. Temperature

Fig 8. Typical Capacitance vs. Drain-to-Source Voltage

Fig 9. Typical Gate Charge vs. Gate-to-Source Voltage

Fig 10. Typical Source-Drain Diode Forward Voltage

Fig 11. Maximum Safe Operating Area

Fig 12. Maximum Drain Current vs. Case Temperature

Fig 13. Typical Threshold Voltage vs. Junction Temperature

Fig 14. Maximum Avalanche Energy vs. Drain Current

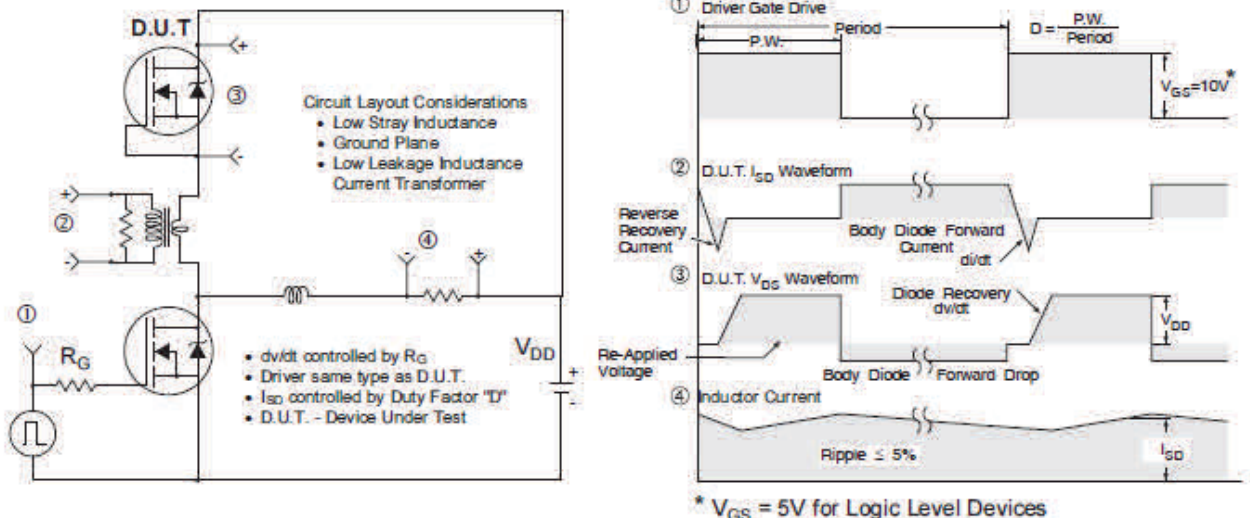

Fig 15. Typical Avalanche Current vs. Pulse width

Notes on Repetitive Avalanche Curves , Figures 15, 16:
(For further info, see AN-1005)

1. Avalanche failures assumption:
Purely a thermal phenomenon and failure occurs at a temperature far in excess of T_{jmax} . This is validated for every part type.
2. Safe operation in Avalanche is allowed as long as T_{jmax} is not exceeded.
3. Equation below based on circuit and waveforms shown in Figures 19a, 19b.
4. $P_D(ave)$ = Average power dissipation per single avalanche pulse.
5. BV = Rated breakdown voltage (1.3 factor accounts for voltage increase during avalanche).
6. I_{av} = Allowable avalanche current.
7. ΔT = Allowable rise in junction temperature, not to exceed T_{jmax} (assumed as 25°C in Figure 15, 16).
 t_{av} = Average time in avalanche.
 D = Duty cycle in avalanche = $t_{av} \cdot f$
 $Z_{thJC}(D, t_{av})$ = Transient thermal resistance, see Figures 3)

$$P_D(ave) = 1/2 (1.3 \cdot BV \cdot I_{av}) = \Delta T / Z_{thJC}$$

$$I_{av} = 2\Delta T / [1.3 \cdot BV \cdot Z_{th}]$$

$$E_{AS(AR)} = P_D(ave) \cdot t_{av}$$

Fig 16. Maximum Avalanche Energy vs. Temperature

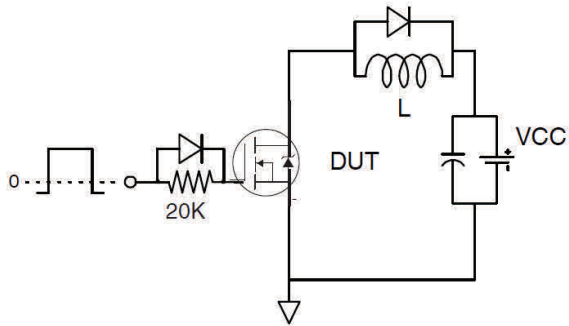
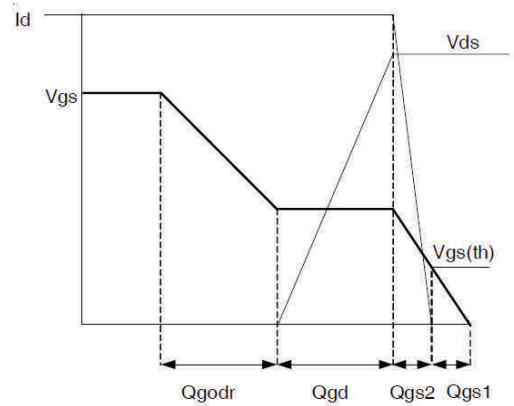
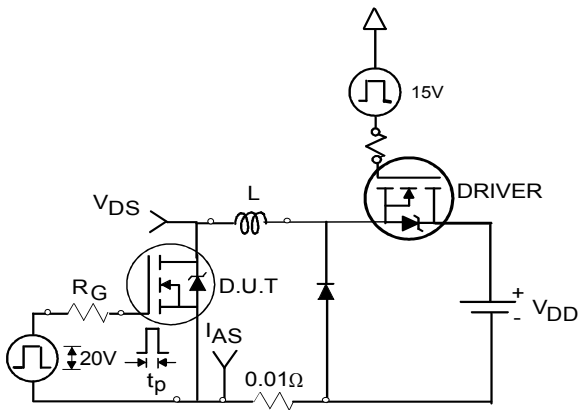
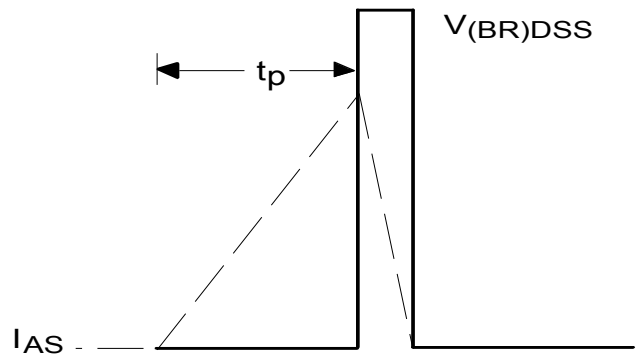
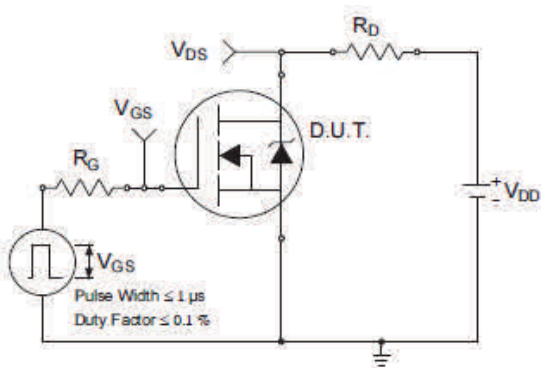
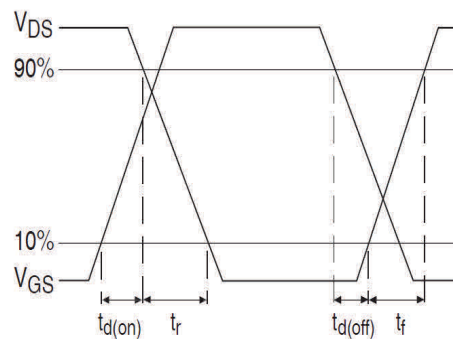
Fig 17. Peak Diode Recovery dv/dt Test Circuit for N-Channel HEXFET® Power MOSFETs

Fig 18a. Gate Charge Test Circuit

Fig 18b. Gate Charge Waveform

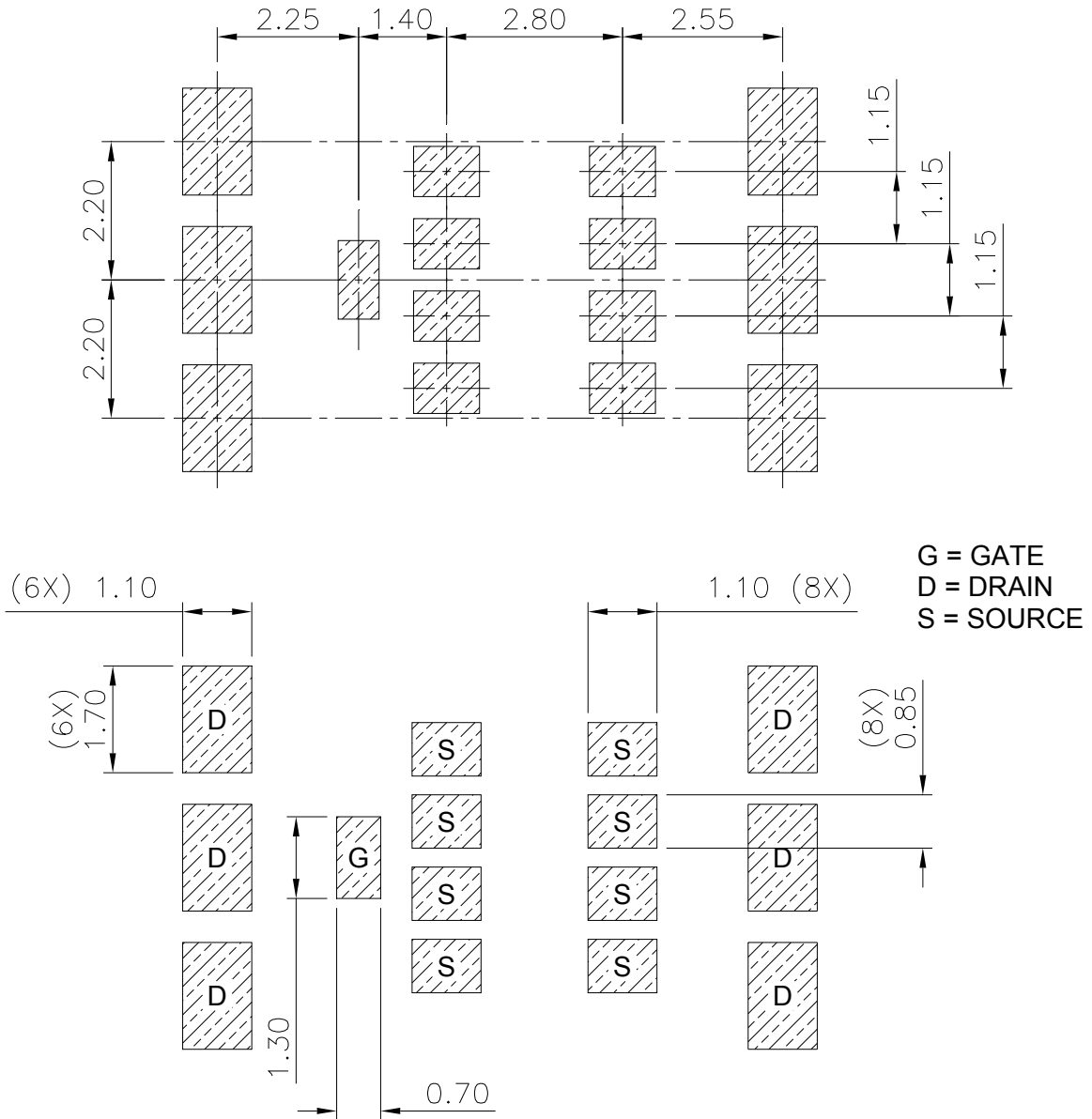
Fig 19a. Unclamped Inductive Test Circuit

Fig 19b. Unclamped Inductive Waveforms

Fig 20a. Switching Time Test Circuit

Fig 20b. Switching Time Waveforms

**DirectFET™ Board Footprint, L8 Outline
(Large Size Can, 8-Source Pads)**

Please see DirectFET™ application note [AN-1035](#) for all details regarding the assembly of DirectFET™. This includes all recommendations for stencil and substrate designs.



Note: For the most current drawing please refer to website at <http://www.irf.com/package/>

**DirectFET® Outline Dimension, L8 Outline
(Large Size Can, 8-Source Pads)**

Please see DirectFET application note [AN-1035](#) for all details regarding the assembly of DirectFET. This includes all recommendations for stencil and substrate designs.

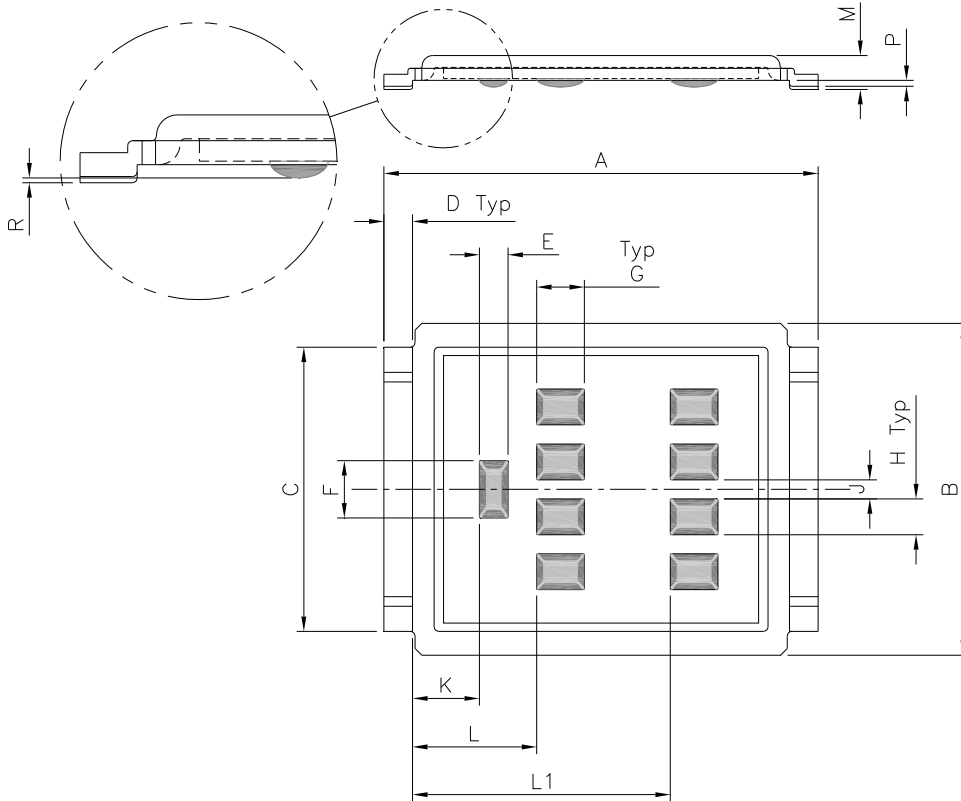

CODE	DIMENSIONS			
	METRIC		IMPERIAL	
A	9.05	9.15	0.356	0.360
B	6.85	7.10	0.270	0.280
C	5.90	6.00	0.232	0.236
D	0.55	0.65	0.022	0.026
E	0.58	0.62	0.023	0.024
F	1.18	1.22	0.046	0.048
G	0.98	1.02	0.039	0.040
H	0.73	0.77	0.029	0.030
J	0.38	0.42	0.015	0.017
K	1.35	1.45	0.053	0.057
L	2.55	2.65	0.100	0.104
L1	5.35	5.45	0.211	0.215
M	0.68	0.74	0.027	0.029
P	0.09	0.17	0.003	0.007
R	0.02	0.08	0.001	0.003

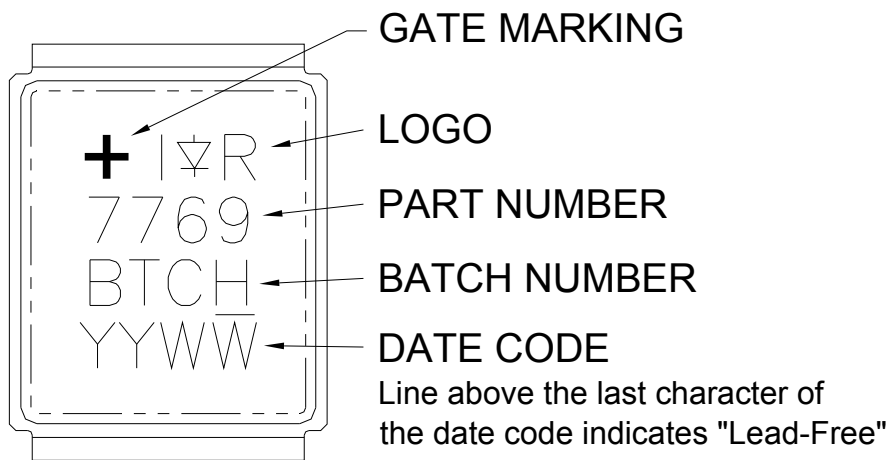
DirectFET™ Part Marking

Note: For the most current drawing please refer to website at <http://www.irf.com/package/>

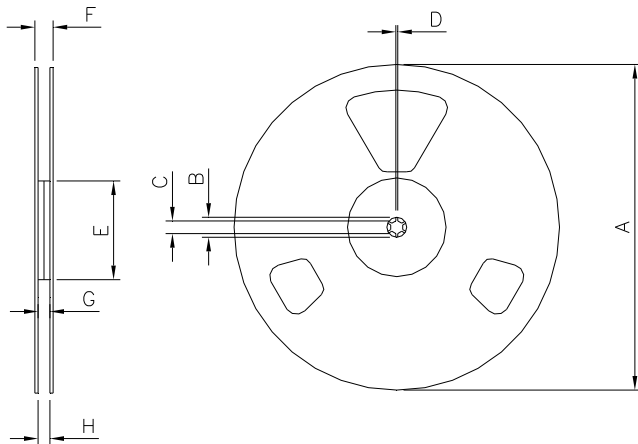
DirectFET™ Tape & Reel Dimension (Showing component orientation).

NOTE: Controlling dimensions in mm
Std reel quantity is 4000 parts. (ordered as IRF7769L1TRPbF).

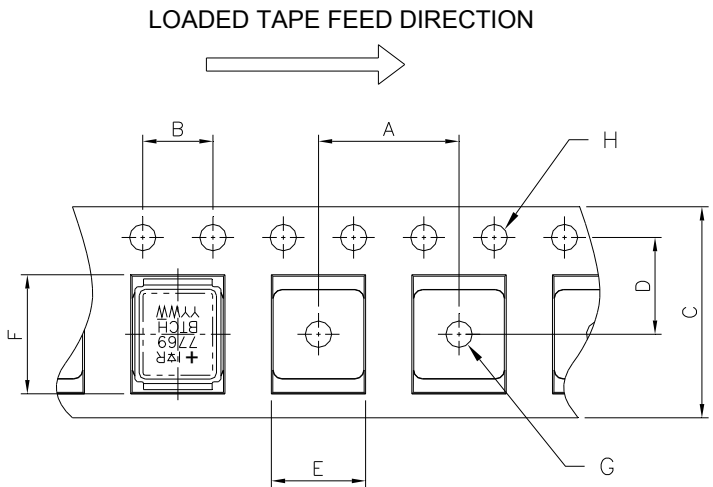

REEL DIMENSIONS				
STANDARD OPTION (QTY 4000)				
	METRIC		IMPERIAL	
CODE	MIN	MAX	MIN	MAX
A	330.00	N.C	12.992	N.C
B	20.20	N.C	0.795	N.C
C	12.80	13.20	0.504	0.520
D	1.50	N.C	0.059	N.C
E	99.00	100.00	3.900	3.940
F	N.C	22.40	N.C	0.880
G	16.40	18.40	0.650	0.720
H	15.90	19.40	0.630	0.760

NOTE: CONTROLLING DIMENSIONS IN MM

DIMENSIONS				
	METRIC		IMPERIAL	
CODE	MIN	MAX	MIN	MAX
A	11.90	12.10	4.69	0.476
B	3.90	4.10	0.154	0.161
C	15.90	16.30	0.623	0.642
D	7.40	7.60	0.291	0.299
E	7.20	7.40	0.283	0.291
F	9.90	10.10	0.390	0.398
G	1.50	N.C	0.059	N.C
H	1.50	1.60	0.059	0.063

Note: For the most current drawing please refer to website at <http://www.irf.com/package/>

Qualification Information

Qualification Level	Industrial * (per JEDEC JESD47F† guidelines)	
Moisture Sensitivity Level	DirectFET (Large -Can)	MSL1 (per JEDEC J-STD-020D†)
RoHS Compliant	Yes	

† Applicable version of JEDEC standard at the time of product release.

* Industrial qualification standards except autoclave test conditions.

Revision History

Date	Comments
2/13/2013	<ul style="list-style-type: none"> • TR1 option removed and Tape & Reel Info updated accordingly. Hyperlinks added throw-out the document
10/14/2016	<ul style="list-style-type: none"> • Changed datasheet with “Infineon” logo –all pages. • Corrected Outline Dimension, L8 Outline on page 9. • Added disclaimer on last page.

Published by
Infineon Technologies AG
81726 München, Germany
© Infineon Technologies AG 2015
All Rights Reserved.

IMPORTANT NOTICE

The information given in this document shall in no event be regarded as a guarantee of conditions or characteristics (“Beschaffenhheitsgarantie”). With respect to any examples, hints or any typical values stated herein and/or any information regarding the application of the product, Infineon Technologies hereby disclaims any and all warranties and liabilities of any kind, including without limitation warranties of non-infringement of intellectual property rights of any third party.

In addition, any information given in this document is subject to customer’s compliance with its obligations stated in this document and any applicable legal requirements, norms and standards concerning customer’s products and any use of the product of Infineon Technologies in customer’s applications.

The data contained in this document is exclusively intended for technically trained staff. It is the responsibility of customer’s technical departments to evaluate the suitability of the product for the intended application and the completeness of the product information given in this document with respect to such application.

For further information on the product, technology, delivery terms and conditions and prices please contact your nearest Infineon Technologies office (www.infineon.com).

WARNINGS

Due to technical requirements products may contain dangerous substances. For information on the types in question please contact your nearest Infineon Technologies office.

Except as otherwise explicitly approved by Infineon Technologies in a written document signed by authorized representatives of Infineon Technologies, Infineon Technologies’ products may not be used in any applications where a failure of the product or any consequences of the use thereof can reasonably be expected to result in personal injury.