

# PXF40xxSxx-Single Output DC/DC Converters

9 to 18 Vdc , 18 to 36 Vdc or 36 to 75 Vdc input, 1.5 to 15 Vdc Single Output, 40W

## TDK·Lambda

### **APPLICATIONS**

Wireless Network  
Telecom/Datacom  
Industry Control System  
Measurement  
Semiconductor Equipment

### **Features**

- Single output current up to 8A
- 40 watts maximum output power
- 2:1 wide input voltage range
- Six-sided continuous shield
- High efficiency up to 90%
- Low profile:2.00×2.00×0.40 inch (50.8×50.8×10.2 mm )
- Fixed switching frequency
- RoHS directive compliant
- Input to output isolation: 1600Vdc,min
- Over-temperature protection
- Input under-voltage protection
- Output over-voltage protection
- Over-current protection, auto-recovery
- Output short circuit protection, auto-recovery
- Remote ON/OFF

### **Options**

- Heat sinks available for extended operation

## General Description

The PXF40-xxSxx series offers 40 watts of output power from a 2 x 2 x 0.4 inch package. It has a 2:1 wide input voltage range of 9-18VDC, 18-36VDC or 36-75VDC and features 1600VDC of isolation, short-circuit and over-voltage protection.

## Table of Contents

Absolute Maximum Rating	P2	Heat Sink Consideration	P53
Output Specification	P2	Remote ON/OFF Control	P54
Input Specification	P3	Mechanical Data	P55
General Specification	P5	Recommended Pad Layout	P56
Characteristic Curves	P6	Output Voltage Adjustment	P57
Test Configurations	P48	Remote Sense Application Circuit	P59
EMC Considerations	P49	Soldering and Reflow Consideration	P59
Input Source Impedance	P51	Packaging Information	P60
Output Over Current Protection	P51	Part Number Structure	P61
Output Over Voltage Protection	P52	Safety and Installation Instructions	P62
Short Circuit Protection	P52	MTBF and Reliability	P62
Thermal Consideration	P52		

Absolute Maximum Rating				
Parameter	Model	Min	Max	Unit
Input Voltage Continuous	12Sxx		18	Vdc
	24Sxx		36	
	48Sxx		75	
Transient (100ms)	12Sxx		36	
	24Sxx		50	
	48Sxx		100	
Operating Ambient Temperature (with derating)	All	-40	85	°C
Operating Case Temperature	All		100	°C
Storage Temperature	All	-55	105	°C

Output Specification					
Parameter	Model	Min	Typ	Max	Unit
Output Voltage ( $V_{in} = V_{in(nom)}$ ; Full Load ; $T_A=25^\circ\text{C}$ )	xxS1P5	1.485	1.5	1.515	Vdc
	xxS1P8	1.782	1.8	1.818	
	xxS2P5	2.475	2.5	2.525	
	xxS3P3	3.267	3.3	3.333	
	xxS05	4.95	5	5.05	
	xxS12	11.88	12	12.12	
	xxS15	14.85	15	15.15	
Voltage Adjustability	All	-10		+10	%
Output Regulation Line ( $V_{in(min)}$ to $V_{in(max)}$ at Full Load) Load (Min. to 100% of Full Load)	All	-0.5		+0.5	%
		-0.5		+0.5	
Output Ripple & Noise Peak-to-Peak (20MHz bandwidth) (Measured with a 0.1 $\mu\text{F}$ /50V MLCC)	xxS1P5		50		mVp-p
	xxS1P8		50		
	xxS2P5		50		
	xxS3P3		50		
	xxS05		50		
	xxS12		75		
xxS15		75			
Temperature Coefficient	All	-0.02		+0.02	%/°C
Output Voltage Overshoot ( $V_{in(min)}$ to $V_{in(max)}$ ; Full Load ; $T_A=25^\circ\text{C}$ )	All		0	3	% $V_b$
Dynamic Load Response ( $V_{in} = V_{in(nom)}$ ; $T_A=25^\circ\text{C}$ ) Load step change from 75% to 100% or 100 to 75% of Full Load Peak Deviation Setting Time ( $V_{OUT}$ - 10% peak deviation)	All		250		mV
	All		250		$\mu\text{S}$
Output Current	xxS1P5	0		8000	mA
	xxS1P8	0		8000	
	xxS2P5	0		8000	
	xxS3P3	0		8000	
	xxS05	0		8000	
	xxS12	0		3333	
	xxS15	0		2666	

Output Specification(Continued)					
Parameter	Model	Min	Typ	Max	Unit
Output Over Voltage Protection (Zener diode clamp)	xxS1P5		3.9		Vdc
	xxS1P8		3.9		
	xxS2P5		3.9		
	xxS3P3		3.9		
	xxS05		6.2		
	xxS12		15		
	xxS15		18		
Output Over Current Protection	All			150	% FL.
Output Short Circuit Protection	All	Hiccup, automatic recovery			

Input Specification					
Parameter	Model	Min	Typ	Max	Unit
Operating Input Voltage	12Sxx	9	12	18	Vdc
	24Sxx	18	24	36	
	48Sxx	36	48	75	
Input Current (Maximum value at $V_{in} = V_{in(nom)}$ ; Full Load)	12S1P5			1250	mA
	12S1P8			1538	
	12S2P5			2083	
	12S3P3			2683	
	12S05			4065	
	12S12			4065	
	12S15			4015	
	24S1P5			649	
	24S1P8			759	
	24S2P5			1016	
	24S3P3			1325	
	24S05			1961	
	24S12			2048	
	24S15			1985	
	48S1P5			321	
	48S1P8			375	
	48S2P5			508	
	48S3P3			655	
	48S05			969	
48S12			1000		
48S15			992		

Input Specification (Continued)					
Parameter	Model	Min	Typ	Max	Unit
Input Standby Current (Typical value at $V_{in} = V_{in(nom)}$ ; No Load)	12S1P5		110		mA
	12S1P8		110		
	12S2P5		110		
	12S3P3		175		
	12S05		225		
	12S12		255		
	12S15		310		
	24S1P5		40		
	24S1P8		40		
	24S2P5		40		
	24S3P3		60		
	24S05		80		
	24S12		70		
	24S15		85		
	48S1P5		25		
	48S1P8		25		
	48S2P5		25		
	48S3P3		35		
	48S05		40		
48S12		50			
48S15		50			
Under Voltage Lockout Turn-on Threshold	12Sxx			9	Vdc
	24Sxx			17.8	
	48Sxx			36	
Under Voltage Lockout Turn-off Threshold	12Sxx		8		Vdc
	24Sxx		16		
	48Sxx		34		
Input Reflected Ripple Current (5 to 20MHz, 12 $\mu$ H Source Impedance)	All		40		mAp-p
Start Up Time ( $V_{in} = V_{in(nom)}$ and Constant Resistive Load)	All			25	mS
Remote ON/OFF				25	
Remote ON/OFF Control (The ON/OFF pin voltage is referenced to $-V_{IN}$ )	All	3.5		12	Vdc
DC-DC OFF		0		1.2	
Remote Off Input Current	All		2.5		mA
Input Current of Remote Control Pin	All	-0.5		0.5	mA



General Specification					
Parameter	Model	Min	Typ	Max	Unit
Efficiency (Vin = Vin(nom) ; Full Load ; TA=25°C)	12S1P5		84		%
	12S1P8		82		
	12S2P5		84		
	12S3P3		86		
	12S05		86		
	12S12		86		
	12S15		87		
	24S1P5		81		
	24S1P8		83		
	24S2P5		86		
	24S3P3		87		
	24S05		89		
	24S12		88		
	24S15		89		
	48S1P5		82		
	48S1P8		84		
	48S2P5		86		
	48S3P3		88		
	48S05		90		
48S12		89			
48S15		89			
Isolation Voltage Input to Output Input to Case, Output to Case	All	1600 1600			Vdc
Isolation Resistance	All	1			GΩ
Isolation Capacitance	All			1000	pF
Switching Frequency	All		300		KHz
Weight	All		60		g
MTBF Bellcore TR-NWT-000332, TC=40°C MIL-HDBK-217F	All		1.398×10 <sup>6</sup> 3.585×10 <sup>5</sup>		hours
Over Temperature Protection	All		115		°C

Characteristic Curves

All test conditions are at 25°C. The figures are identical for PXF40-12S1P5 **PRODUCT NOT AVAILABLE**

Efficiency Versus Output Current

Power Dissipation Versus Output Current

Efficiency Versus Input Voltage. Full Load

Derating Output Current Versus Ambient Temperature and Airflow  
 $V_{in} = V_{in(nom)}$

Derating Output Current Versus Ambient Temperature with Heat-Sink  
and Airflow,  $V_{in} = V_{in(nom)}$

Characteristic Curves (Continued)

All test conditions are at 25°C. The figures are identical for PXF40-12S1P5 **PRODUCT NOT AVAILABLE**

Typical Output Ripple and Noise.  
Vin = Vin(nom), Full Load

Transient Response to Dynamic Load Change from  
100% to 75% to 100% of Full Load ; Vin = Vin(nom)

Typical Input Start-Up and Output Rise Characteristic  
Vin = Vin(nom), Full Load

Using ON/OFF Voltage Start-Up and Vo Rise Characteristic  
Vin = Vin(nom), Full Load

Conduction Emission of EN55022 Class A  
Vin = Vin(nom), Full Load

Conduction Emission of EN55022 Class B  
Vin = Vin(nom), Full Load

Characteristic Curves (Continued)

All test conditions are at 25°C. The figures are identical for PXF40-12S1P8 **PRODUCT NOT AVAILABLE**

Efficiency Versus Output Current

Power Dissipation Versus Output Current

Efficiency Versus Input Voltage. Full Load

Derating Output Current Versus Ambient Temperature and Airflow  
 $V_{in} = V_{in(nom)}$

Derating Output Current Versus Ambient Temperature with Heat-Sink  
and Airflow,  $V_{in} = V_{in(nom)}$

Characteristic Curves (Continued)

All test conditions are at 25°C. The figures are identical for PXF40-12S1P8 **PRODUCT NOT AVAILABLE**

Typical Output Ripple and Noise.  
Vin=Vin(nom), Full Load

Transient Response to Dynamic Load Change from  
100% to 75% to 100% of Full Load ; Vin=Vin(nom)

Typical Input Start-Up and Output Rise Characteristic  
Vin=Vin(nom), Full Load

Using ON/OFF Voltage Start-Up and Vo Rise Characteristic  
Vin=Vin(nom), Full Load

Conduction Emission of EN55022 Class A  
Vin=Vin(nom), Full Load

Conduction Emission of EN55022 Class B  
Vin=Vin(nom), Full Load

Characteristic Curves (Continued)

All test conditions are at 25°C. The figures are identical for PXF40-12S2P5

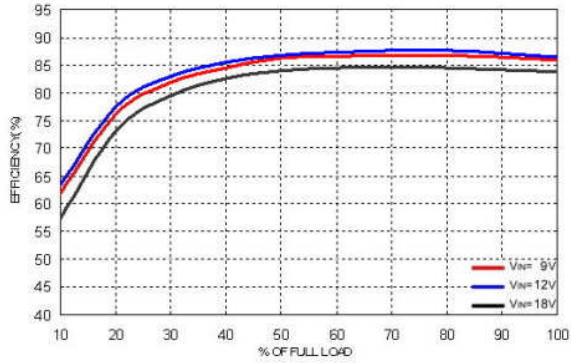

Efficiency Versus Output Current

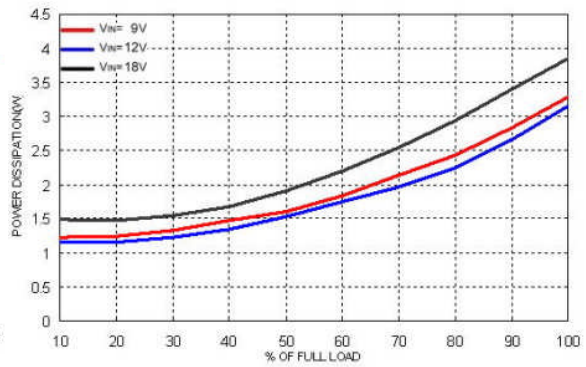

Power Dissipation Versus Output Current

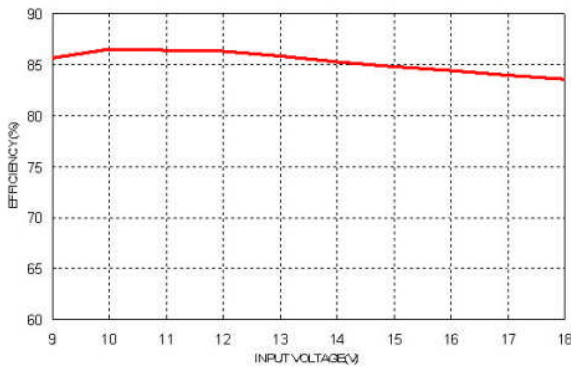

Efficiency Versus Input Voltage. Full Load

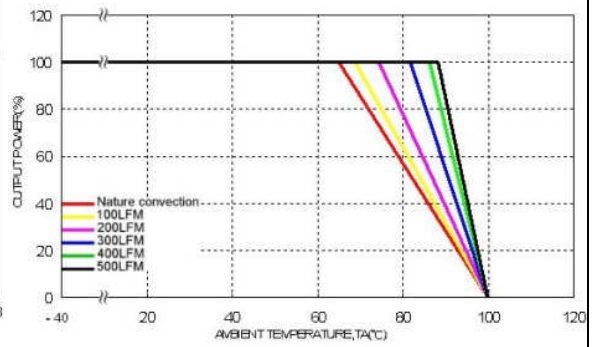

Derating Output Current Versus Ambient Temperature and Airflow  
Vin=Vin(nom)

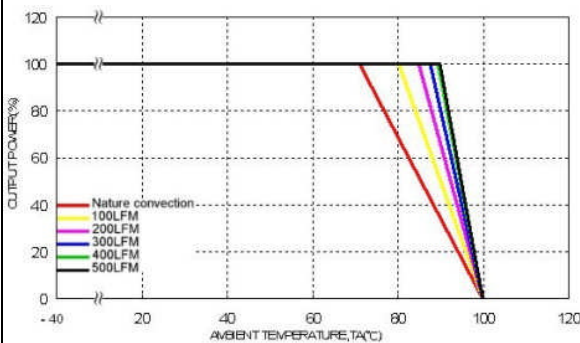

Derating Output Current Versus Ambient Temperature with Heat-Sink and Airflow, Vin = Vin(nom)

Characteristic Curves (Continued)

All test conditions are at 25°C. The figures are identical for PXF40-12S2P5

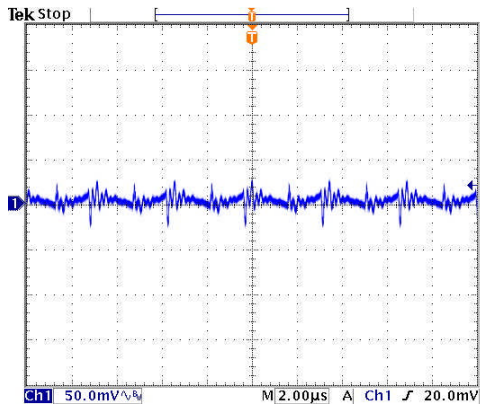

Typical Output Ripple and Noise.  
Vin=Vin(nom), Full Load

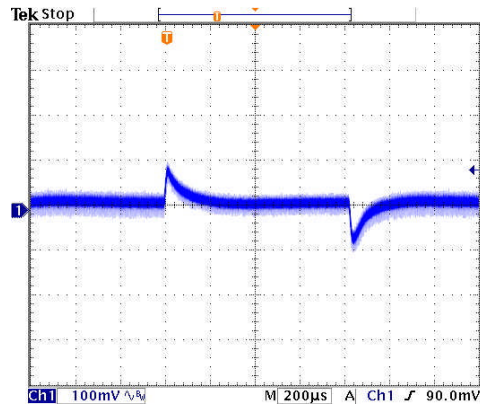

Transient Response to Dynamic Load Change from 100% to 75% to 100% of Full Load ; Vin=Vin(nom)

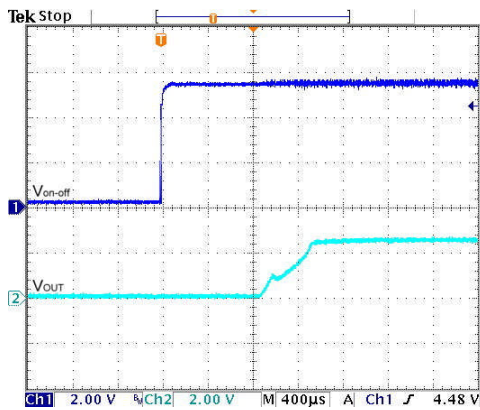

Using ON/OFF Voltage Start-Up and Vo Rise Characteristic  
Vin=Vin(nom), Full Load

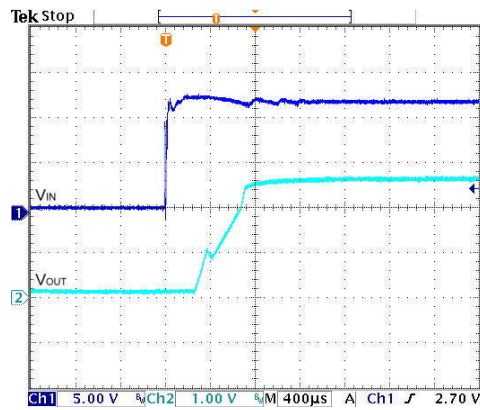

Typical Input Start-Up and Output Rise Characteristic  
Vin=Vin(nom), Full Load

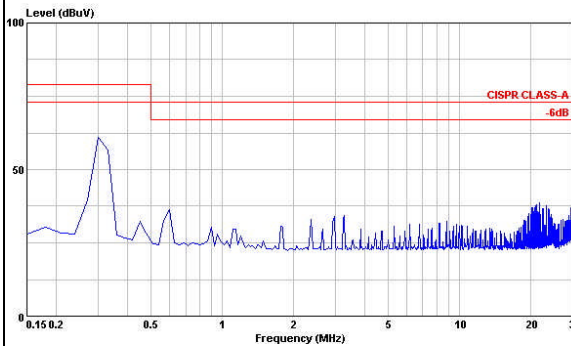

Conduction Emission of EN55022 Class A  
Vin=Vin(nom), Full Load

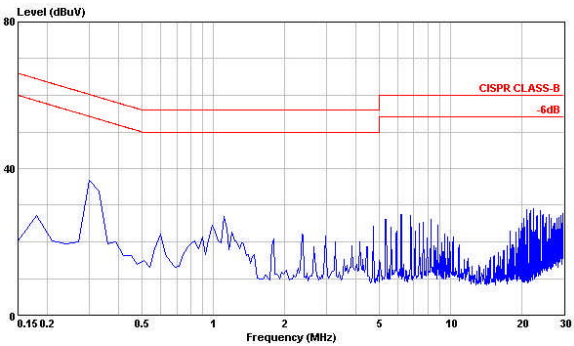

Conduction Emission of EN55022 Class B  
Vin=Vin(nom), Full Load

Characteristic Curves (Continued)

All test conditions are at 25°C. The figures are identical for PXF40-12S3P3

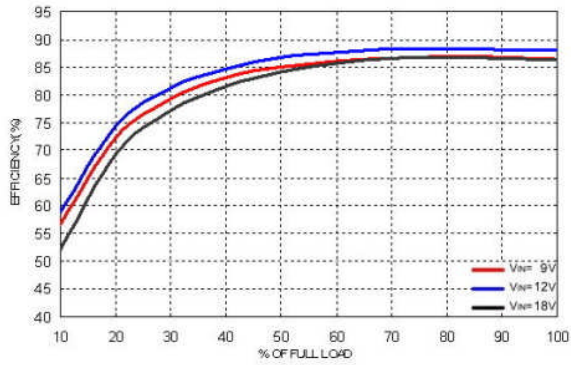

Efficiency Versus Output Current

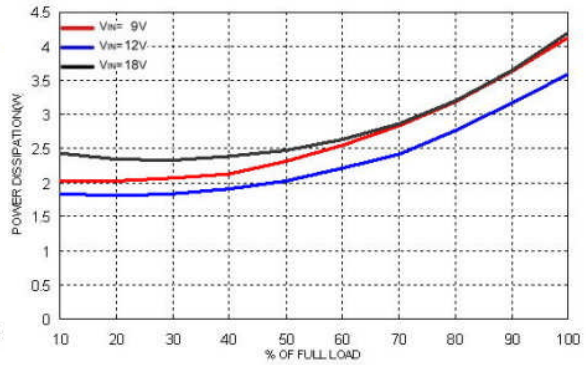

Power Dissipation Versus Output Current

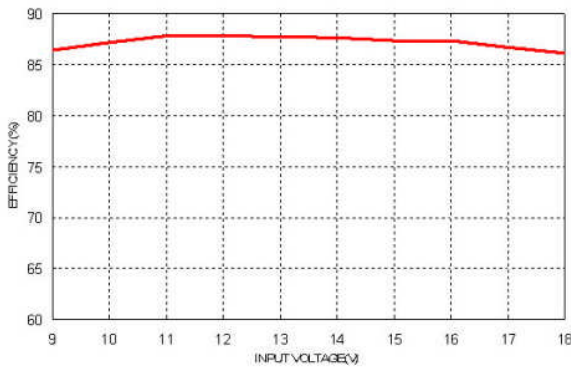

Efficiency Versus Input Voltage. Full Load

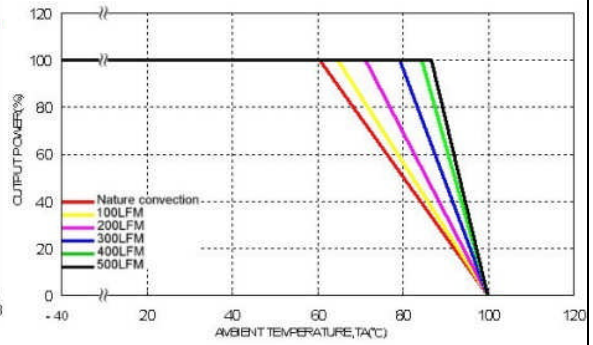

Derating Output Current Versus Ambient Temperature and Airflow  
Vin=Vin(nom)

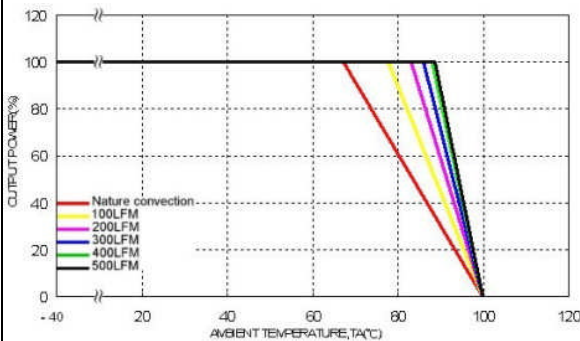

Derating Output Current Versus Ambient Temperature with Heat-Sink  
and Airflow, Vin = Vin(nom)



Characteristic Curves (Continued)

All test conditions are at 25°C. The figures are identical for PXF40-12S3P3

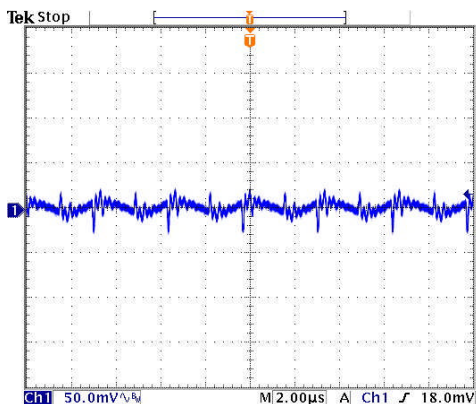

Typical Output Ripple and Noise.  
Vin=Vin(nom), Full Load

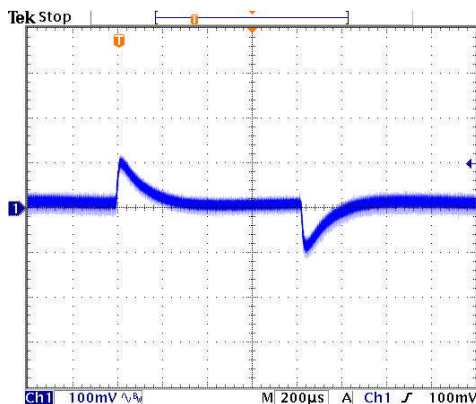

Transient Response to Dynamic Load Change from 100% to 75% to 100% of Full Load ; Vin=Vin(nom)

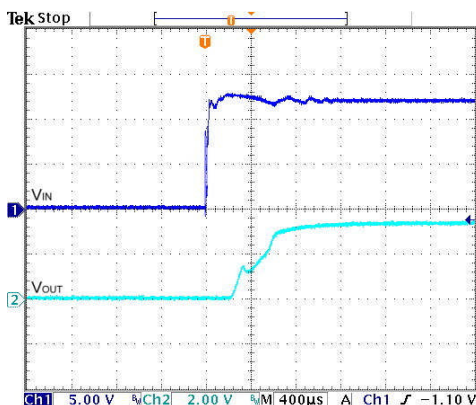

Typical Input Start-Up and Output Rise Characteristic  
Vin=Vin(nom), Full Load

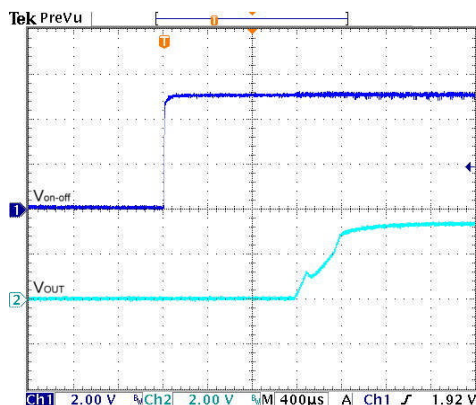

Using ON/OFF Voltage Start-Up and Vo Rise Characteristic  
Vin=Vin(nom), Full Load

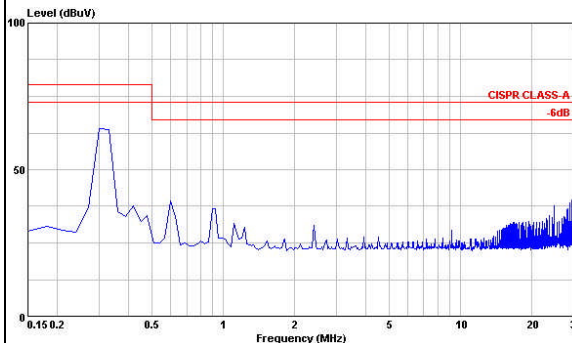

Conduction Emission of EN55022 Class A  
Vin=Vin(nom), Full Load

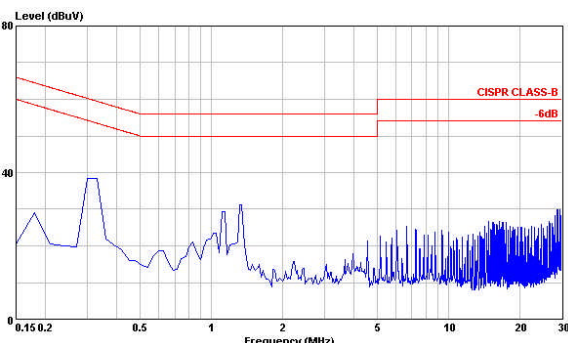

Conduction Emission of EN55022 Class B  
Vin=Vin(nom), Full Load

Characteristic Curves (Continued)

All test conditions are at 25°C. The figures are identical for PXF40-12S05

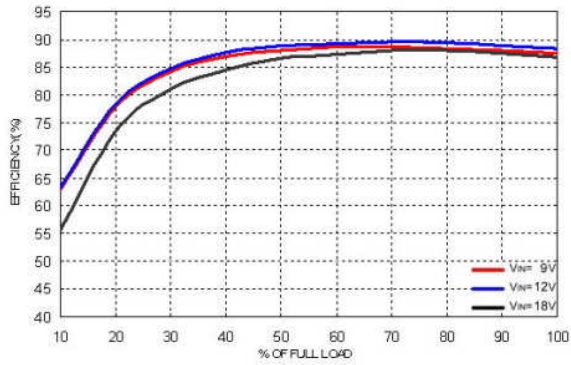

Efficiency Versus Output Current

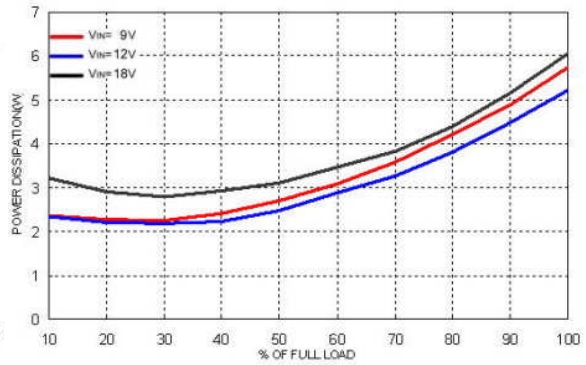

Power Dissipation Versus Output Current

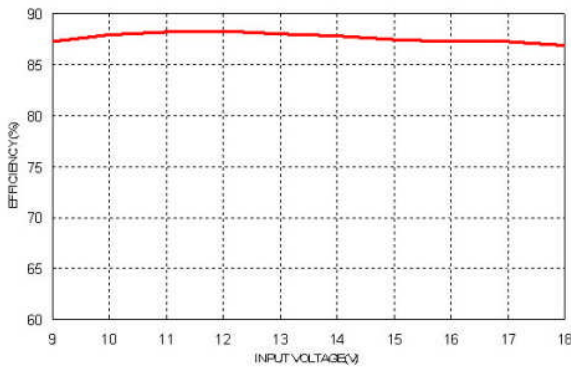

Efficiency Versus Input Voltage. Full Load

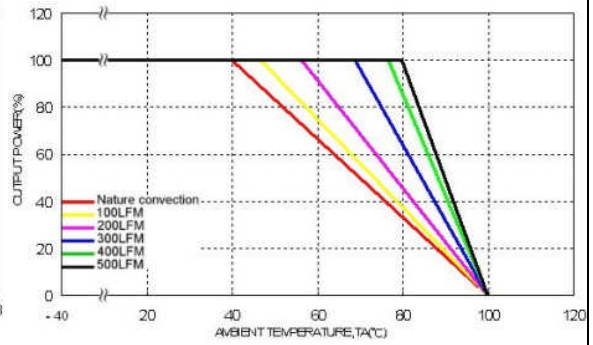

Derating Output Current Versus Ambient Temperature and Airflow  
Vin=Vin(nom)

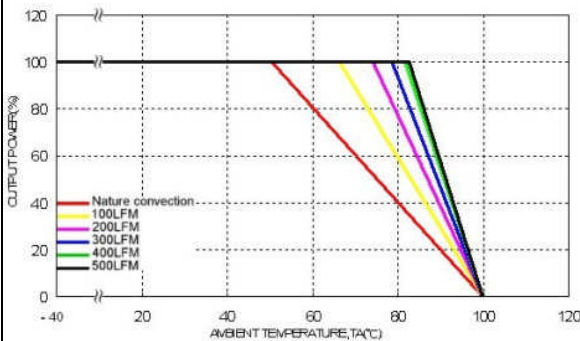

Derating Output Current Versus Ambient Temperature with Heat-Sink  
and Airflow, Vin = Vin(nom)

Characteristic Curves (Continued)

All test conditions are at 25°C. The figures are identical for PXF40-12S05

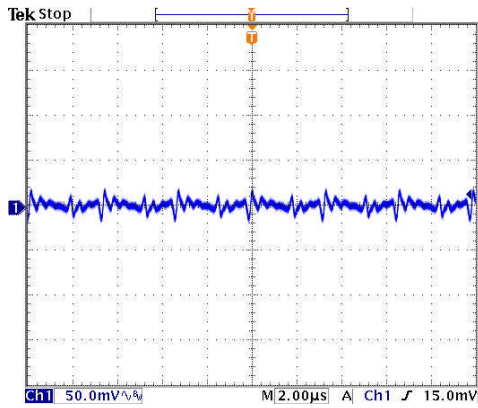

Typical Output Ripple and Noise.  
Vin=Vin(nom), Full Load

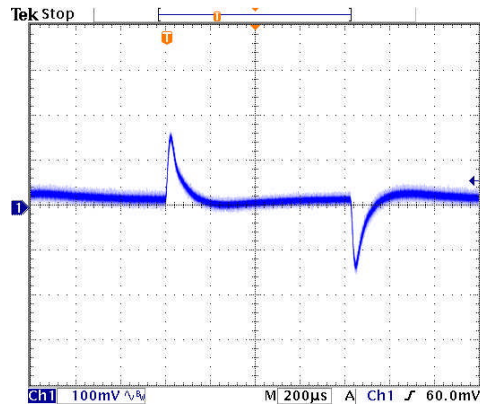

Transient Response to Dynamic Load Change from 100% to 75% to 100% of Full Load ; Vin=Vin(nom)

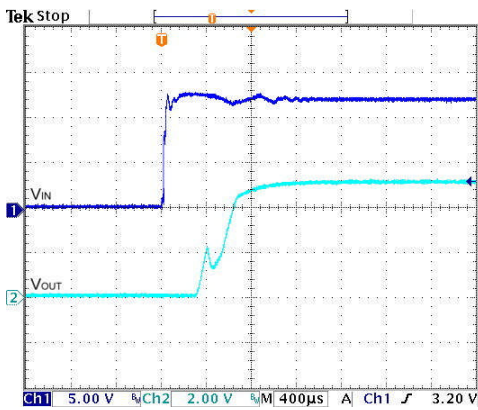

Typical Input Start-Up and Output Rise Characteristic  
Vin=Vin(nom), Full Load

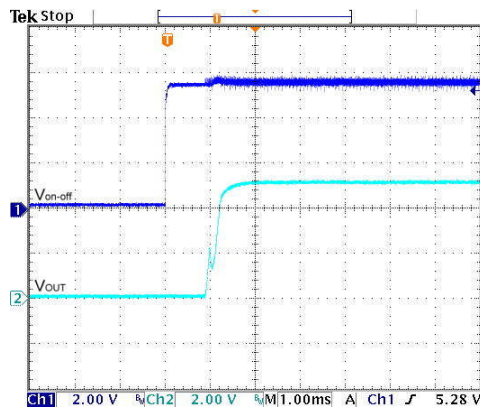

Using ON/OFF Voltage Start-Up and Vo Rise Characteristic  
Vin=Vin(nom), Full Load

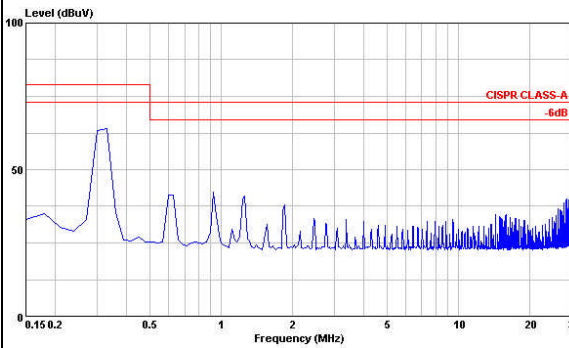

Conduction Emission of EN55022 Class A  
Vin=Vin(nom), Full Load

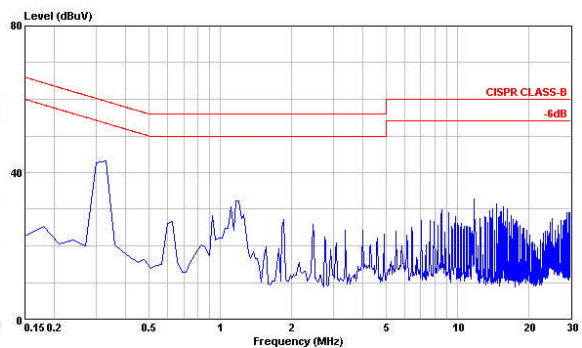

Conduction Emission of EN55022 Class B  
Vin=Vin(nom), Full Load

Characteristic Curves (Continued)

All test conditions are at 25°C. The figures are identical for PXF40-12S12

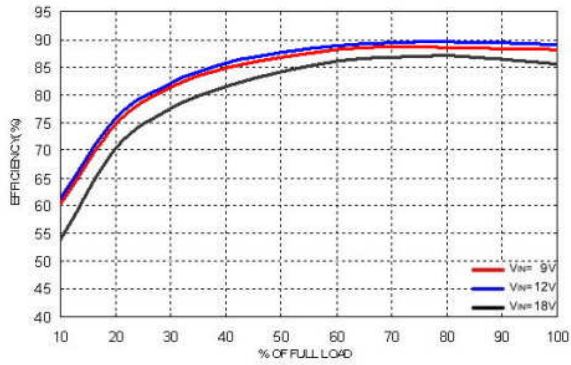

Efficiency Versus Output Current

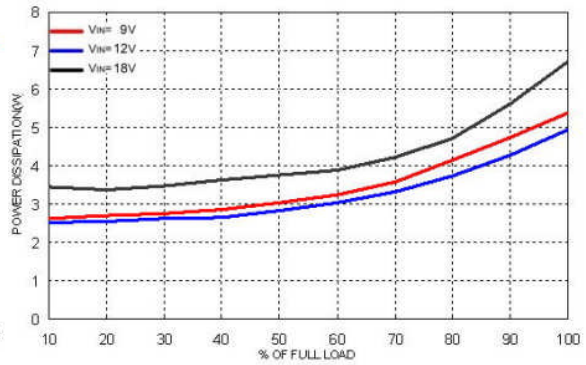

Power Dissipation Versus Output Current

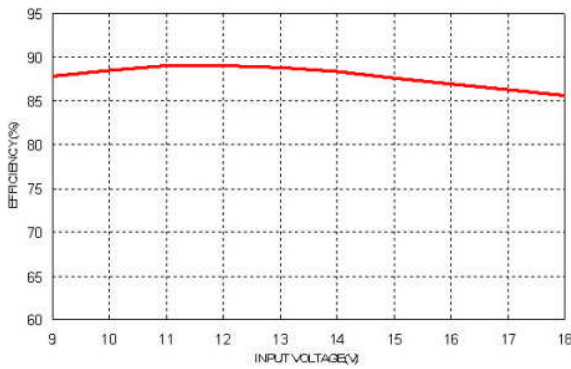

Efficiency Versus Input Voltage. Full Load

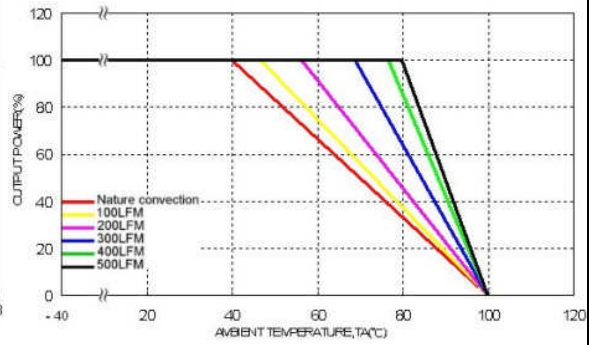

Derating Output Current Versus Ambient Temperature and Airflow  
Vin=Vin(nom)

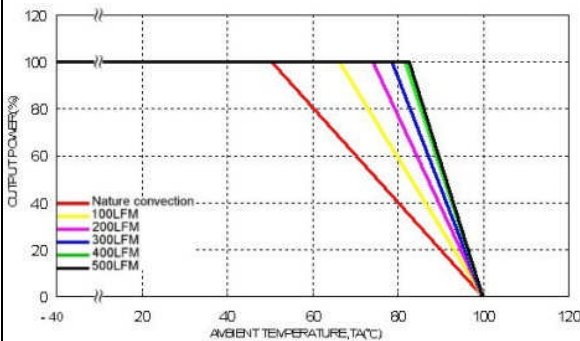

Derating Output Current Versus Ambient Temperature with Heat-Sink  
and Airflow, Vin = Vin(nom)



Characteristic Curves (Continued)

All test conditions are at 25°C. The figures are identical for PXF40-12S12

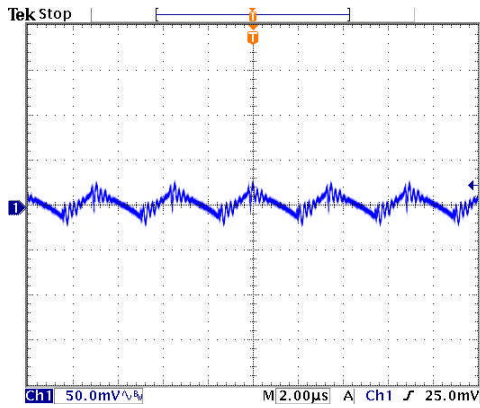

Typical Output Ripple and Noise.  
Vin=Vin(nom), Full Load

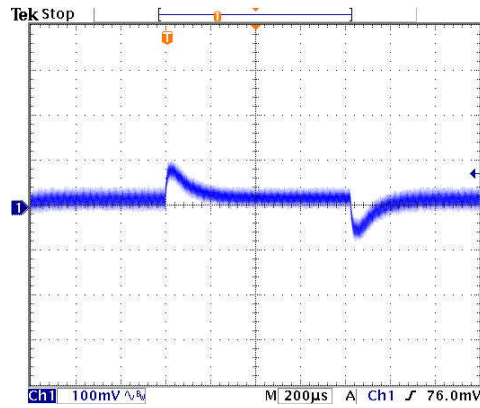

Transient Response to Dynamic Load Change from 100% to 75% to 100% of Full Load ; Vin=Vin(nom)

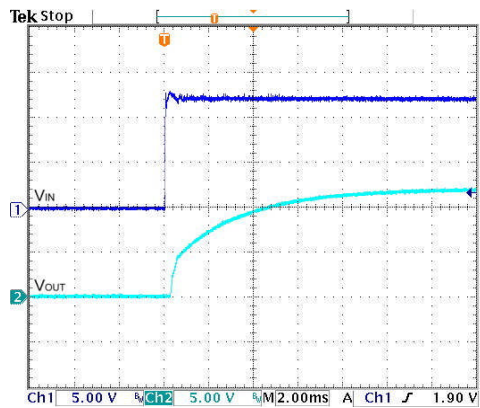

Typical Input Start-Up and Output Rise Characteristic  
Vin=Vin(nom), Full Load

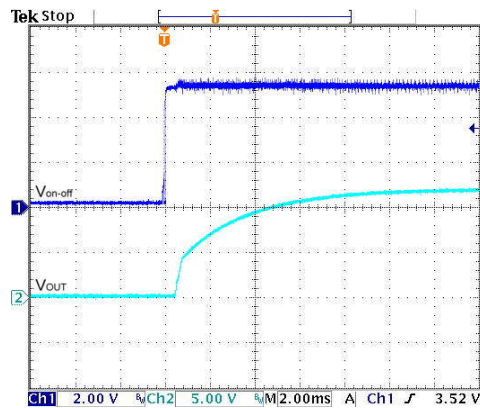

Using ON/OFF Voltage Start-Up and Vo Rise Characteristic  
Vin=Vin(nom), Full Load

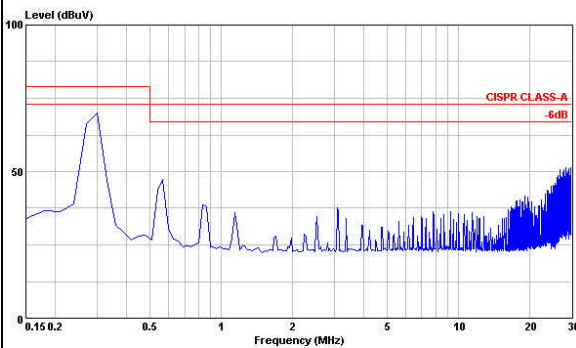

Conduction Emission of EN55022 Class A  
Vin=Vin(nom), Full Load

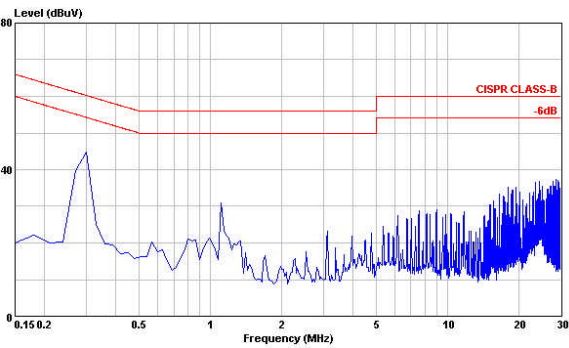

Conduction Emission of EN55022 Class B  
Vin=Vin(nom), Full Load

Characteristic Curves (Continued)

All test conditions are at 25°C. The figures are identical for PXF40-12S15

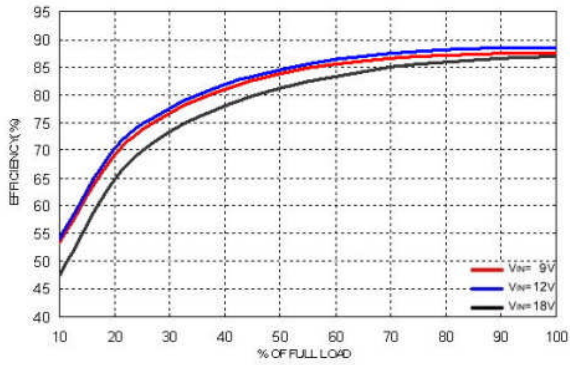

Efficiency Versus Output Current

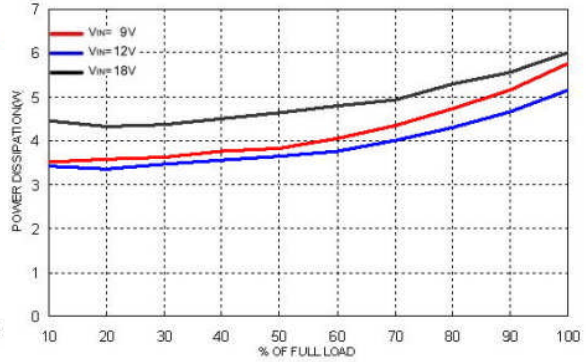

Power Dissipation Versus Output Current

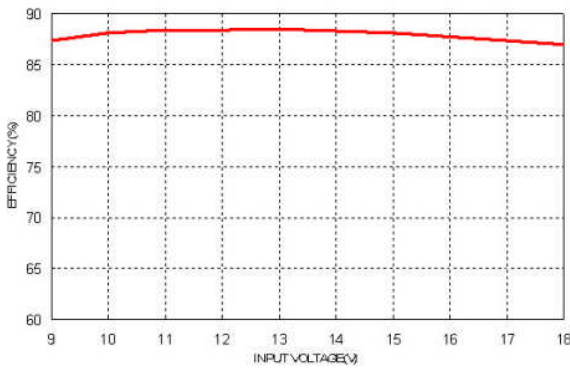

Efficiency Versus Input Voltage. Full Load

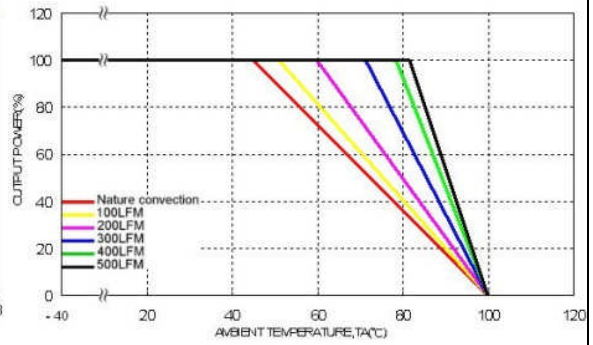

Derating Output Current Versus Ambient Temperature and Airflow  
Vin=Vin(nom)

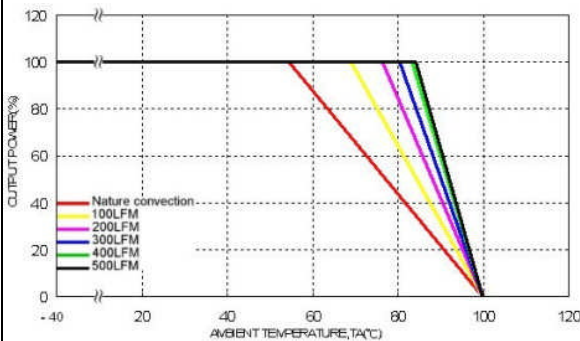

Derating Output Current Versus Ambient Temperature with Heat-Sink  
and Airflow, Vin = Vin(nom)

Characteristic Curves (Continued)

All test conditions are at 25°C. The figures are identical for PXF40-12S15

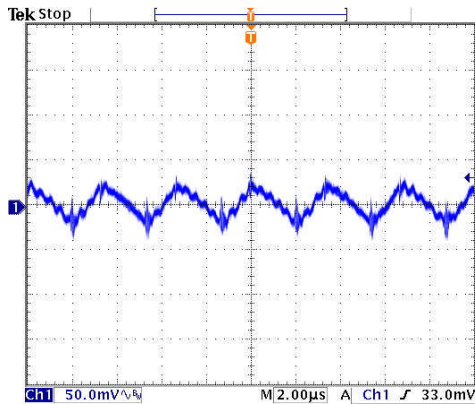

Typical Output Ripple and Noise.  
Vin=Vin(nom), Full Load

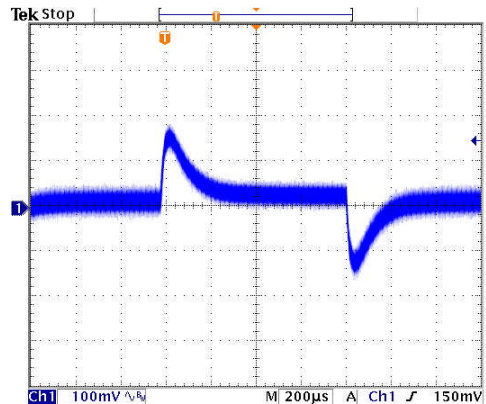

Transient Response to Dynamic Load Change from 100% to 75% to 100% of Full Load ; Vin=Vin(nom)

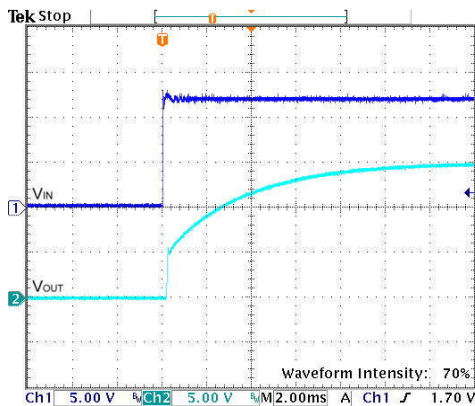

Typical Input Start-Up and Output Rise Characteristic  
Vin=Vin(nom), Full Load

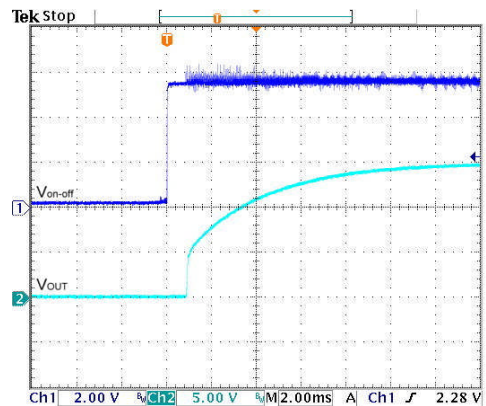

Using ON/OFF Voltage Start-Up and V<sub>o</sub> Rise Characteristic  
Vin=Vin(nom), Full Load

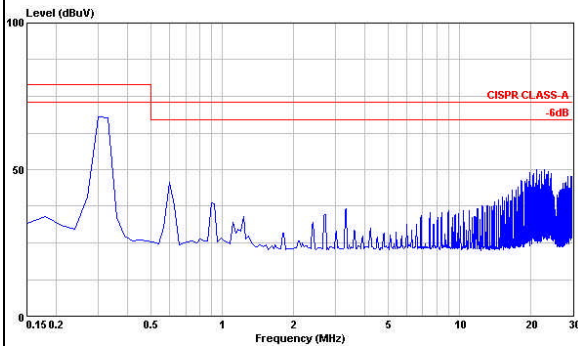

Conduction Emission of EN55022 Class A  
Vin=Vin(nom), Full Load

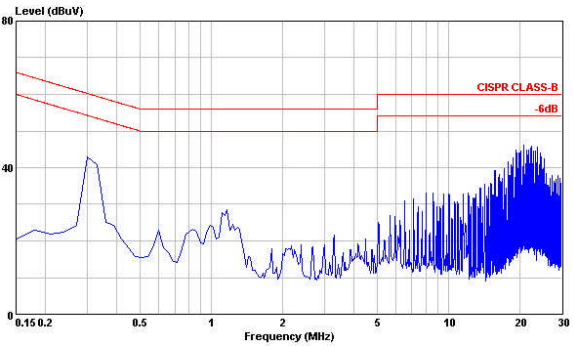

Conduction Emission of EN55022 Class B  
Vin=Vin(nom), Full Load

Characteristic Curves (Continued)

All test conditions are at 25°C. The figures are identical for PXF40-24S1P5 **PRODUCT NOT AVAILABLE**

Efficiency Versus Output Current

Power Dissipation Versus Output Current

Efficiency Versus Input Voltage. Full Load

Derating Output Current Versus Ambient Temperature and Airflow  
 $V_{in} = V_{in(nom)}$

Derating Output Current Versus Ambient Temperature with Heat-Sink  
and Airflow,  $V_{in} = V_{in(nom)}$



Characteristic Curves (Continued)

All test conditions are at 25°C. The figures are identical for PXF40-24S1P5 **PRODUCT NOT AVAILABLE**

Typical Output Ripple and Noise.  
Vin=Vin(nom), Full Load

Transient Response to Dynamic Load Change from  
100% to 75% to 100% of Full Load ; Vin=Vin(nom)

Typical Input Start-Up and Output Rise Characteristic  
Vin=Vin(nom), Full Load

Using ON/OFF Voltage Start-Up and Vo Rise Characteristic  
Vin=Vin(nom), Full Load

Conduction Emission of EN55022 Class A  
Vin=Vin(nom), Full Load

Conduction Emission of EN55022 Class B  
Vin=Vin(nom), Full Load

Characteristic Curves (Continued)

All test conditions are at 25°C. The figures are identical for PXF40-24S1P8

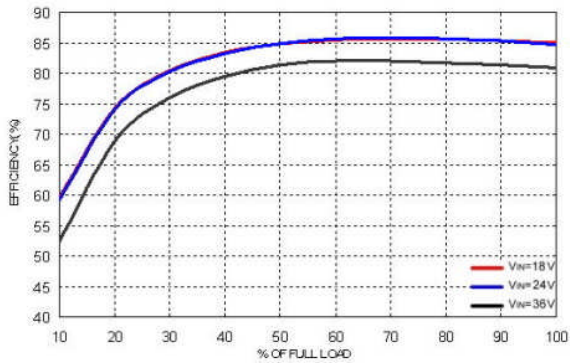

Efficiency Versus Output Current

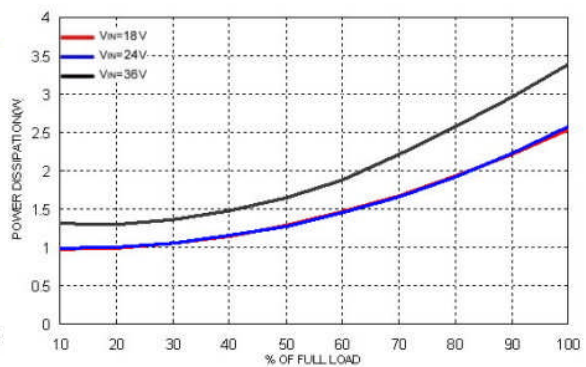

Power Dissipation Versus Output Current

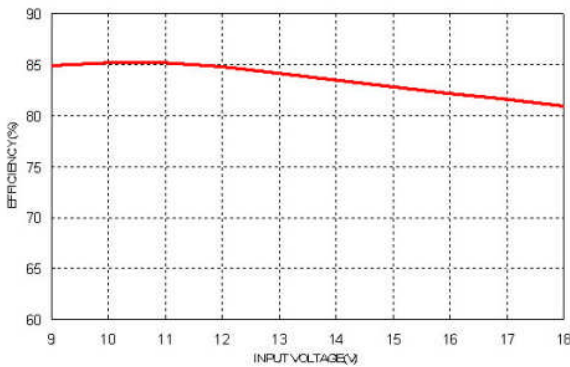

Efficiency Versus Input Voltage. Full Load

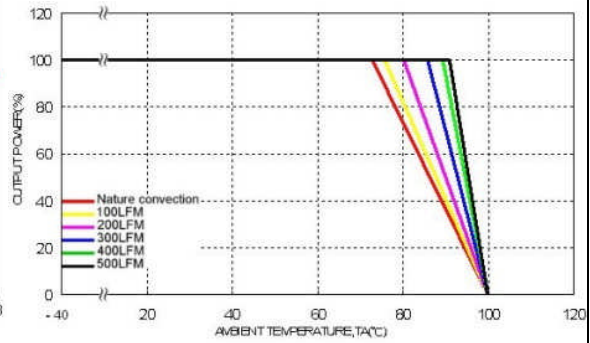

Derating Output Current Versus Ambient Temperature and Airflow  
V<sub>in</sub>=V<sub>in</sub>(nom)

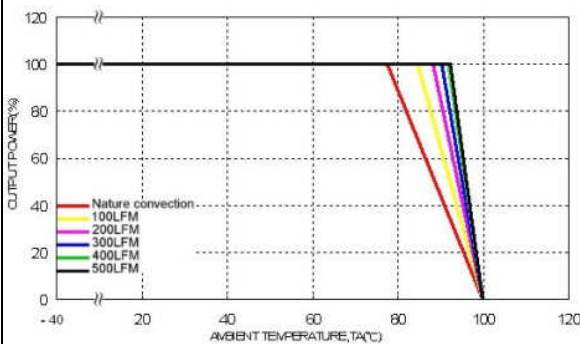

Derating Output Current Versus Ambient Temperature with Heat-Sink  
and Airflow, V<sub>in</sub> = V<sub>in</sub>(nom)

Characteristic Curves (Continued)

All test conditions are at 25°C. The figures are identical for PXF40-24S1P8

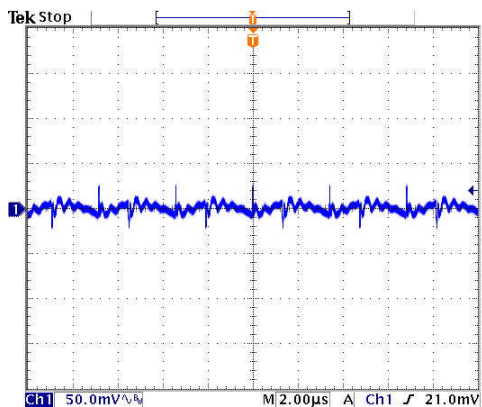

Typical Output Ripple and Noise.  
Vin=Vin(nom), Full Load

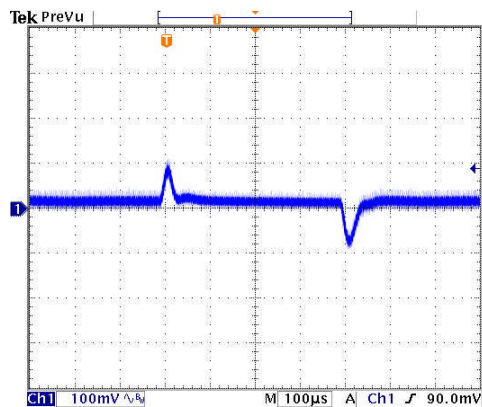

Transient Response to Dynamic Load Change from 100% to 75% to 100% of Full Load ; Vin=Vin(nom)

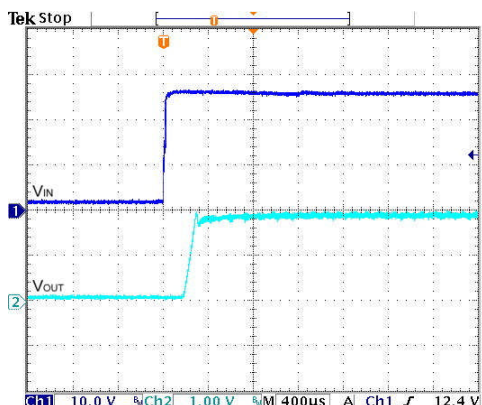

Typical Input Start-Up and Output Rise Characteristic  
Vin=Vin(nom), Full Load

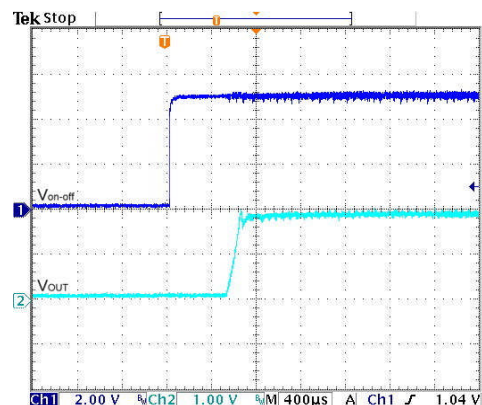

Using ON/OFF Voltage Start-Up and Vo Rise Characteristic  
Vin=Vin(nom), Full Load

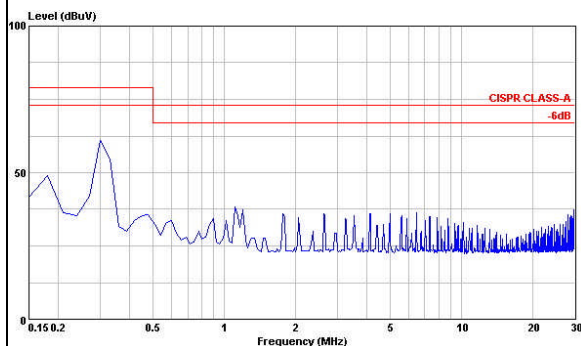

Conduction Emission of EN55022 Class A  
Vin=Vin(nom), Full Load

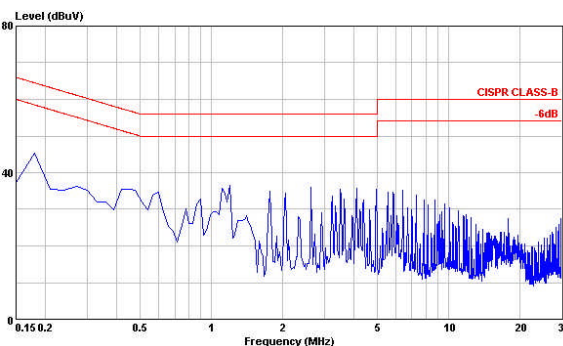

Conduction Emission of EN55022 Class B  
Vin=Vin(nom), Full Load

Characteristic Curves (Continued)

All test conditions are at 25°C. The figures are identical for PXF40-24S2P5

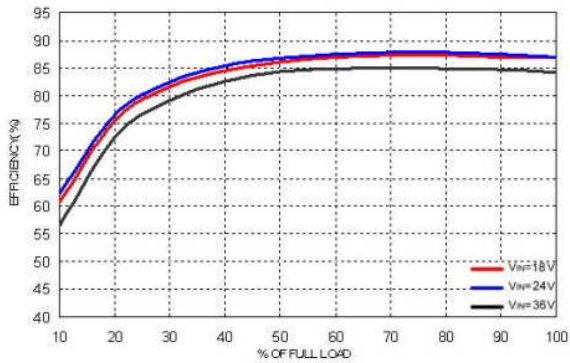

Efficiency Versus Output Current

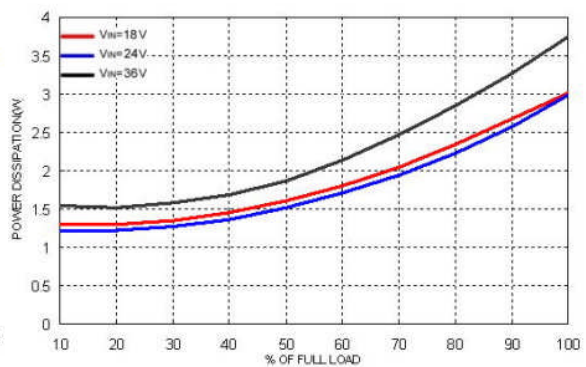

Power Dissipation Versus Output Current

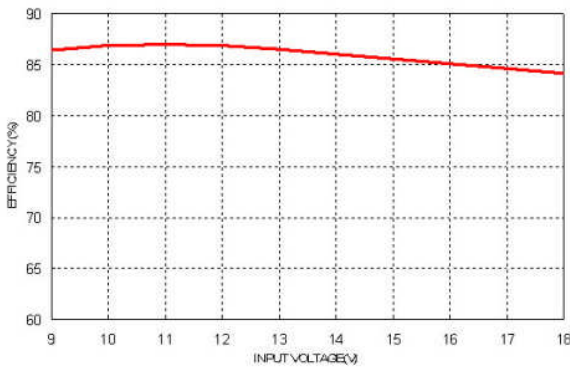

Efficiency Versus Input Voltage. Full Load

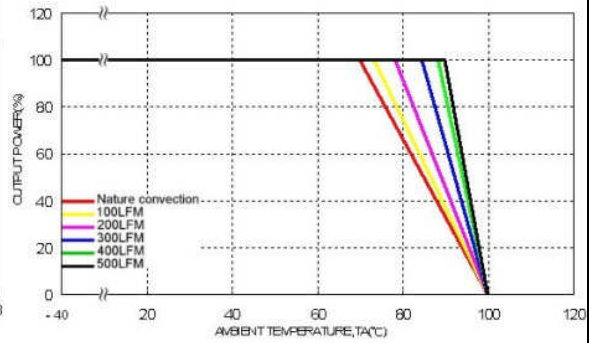

Derating Output Current Versus Ambient Temperature and Airflow  
Vin=Vin(nom)

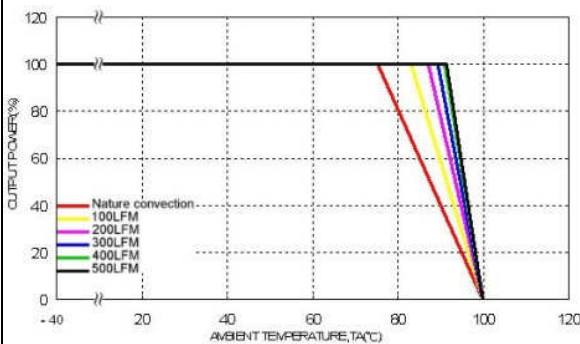

Derating Output Current Versus Ambient Temperature with Heat-Sink  
and Airflow, Vin = Vin(nom)

Characteristic Curves (Continued)

All test conditions are at 25°C. The figures are identical for PXF40-24S2P5

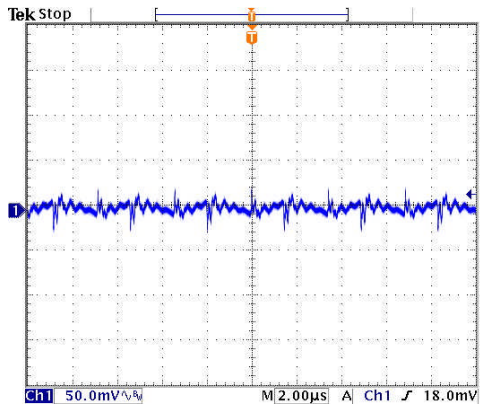

Typical Output Ripple and Noise.  
Vin=Vin(nom), Full Load

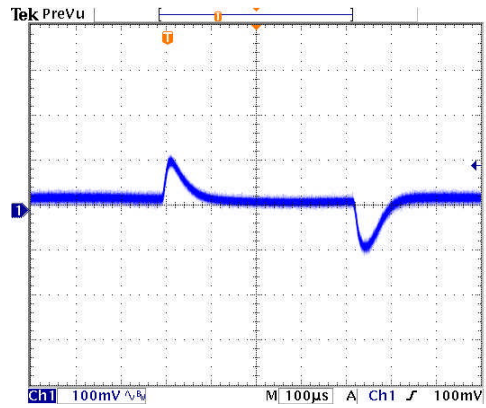

Transient Response to Dynamic Load Change from 100% to 75% to 100% of Full Load ; Vin=Vin(nom)

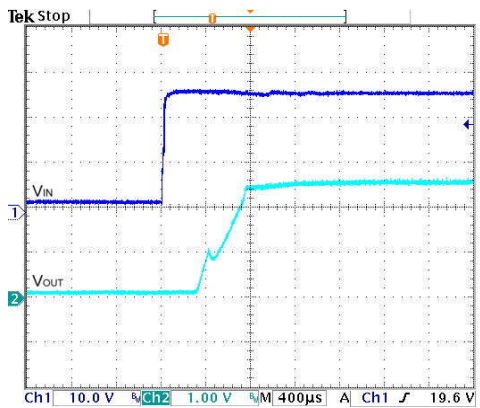

Typical Input Start-Up and Output Rise Characteristic  
Vin=Vin(nom), Full Load

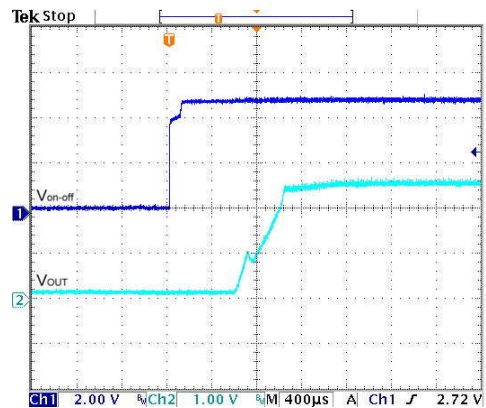

Using ON/OFF Voltage Start-Up and V<sub>O</sub> Rise Characteristic  
Vin=Vin(nom), Full Load

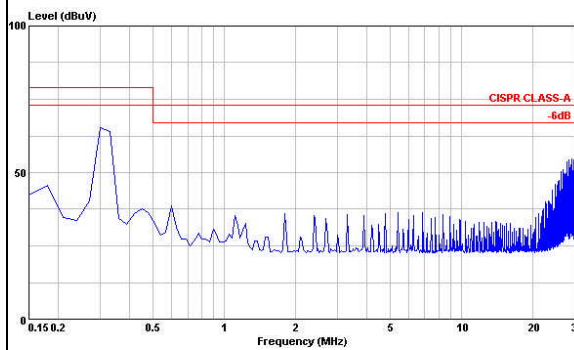

Conduction Emission of EN55022 Class A  
Vin=Vin(nom), Full Load

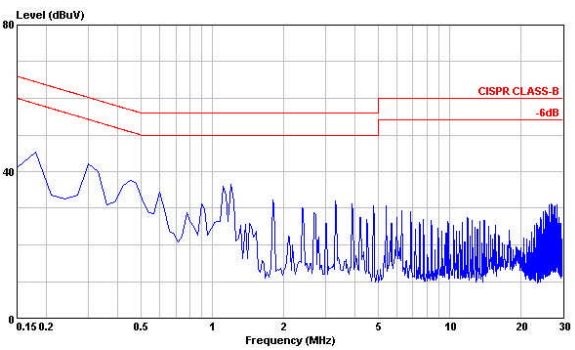

Conduction Emission of EN55022 Class B  
Vin=Vin(nom), Full Load



Characteristic Curves (Continued)

All test conditions are at 25°C. The figures are identical for PXF40-24S3P3

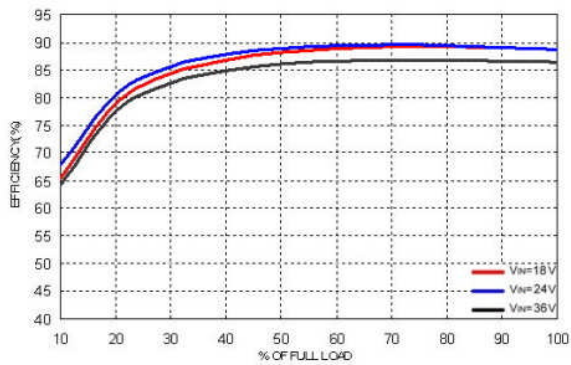

Efficiency Versus Output Current

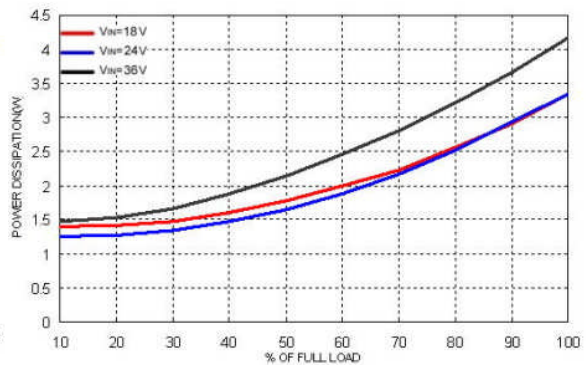

Power Dissipation Versus Output Current

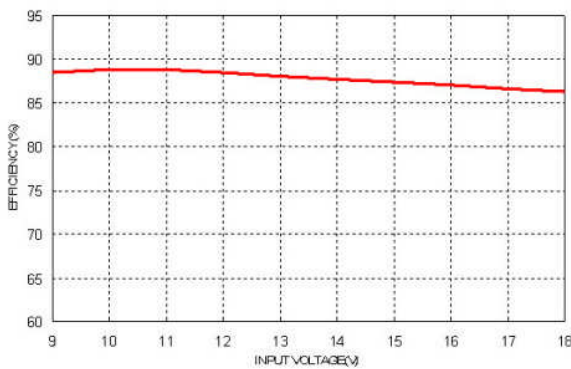

Efficiency Versus Input Voltage. Full Load

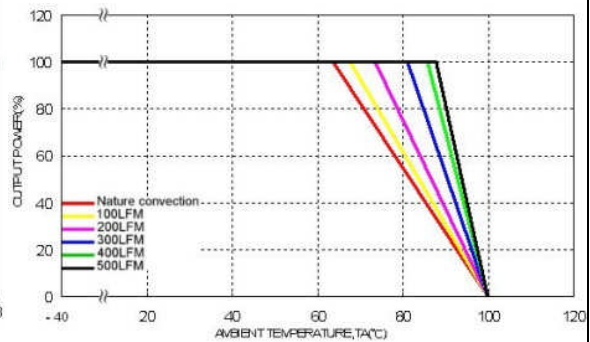

Derating Output Current Versus Ambient Temperature and Airflow  
Vin=Vin(nom)

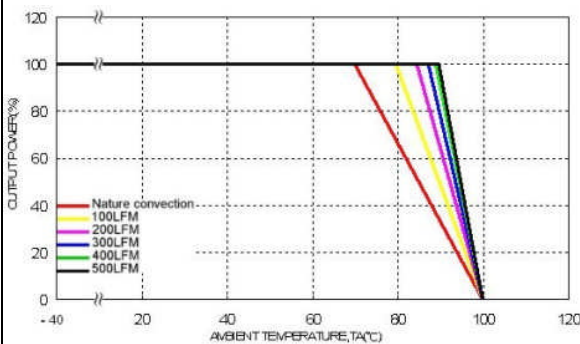

Derating Output Current Versus Ambient Temperature with Heat-Sink  
and Airflow, Vin = Vin(nom)

Characteristic Curves (Continued)

All test conditions are at 25°C. The figures are identical for PXF40-24S3P3

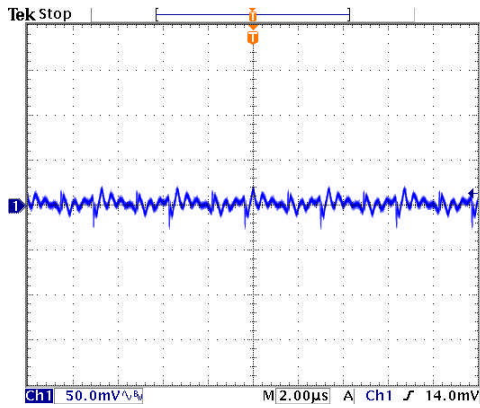

Typical Output Ripple and Noise.  
Vin=Vin(nom), Full Load

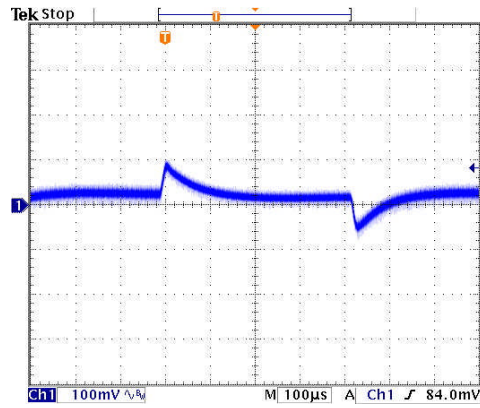

Transient Response to Dynamic Load Change from 100% to 75% to 100% of Full Load ; Vin=Vin(nom)

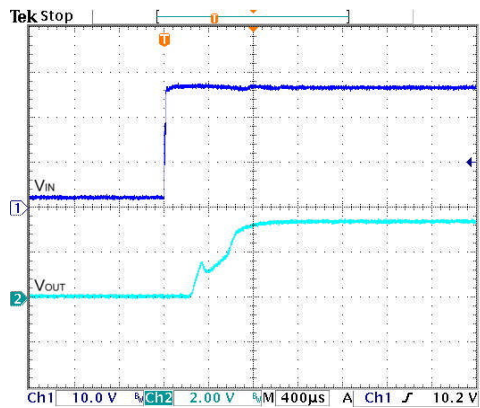

Typical Input Start-Up and Output Rise Characteristic  
Vin=Vin(nom), Full Load

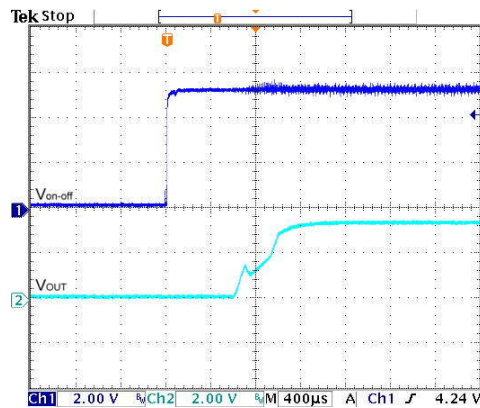

Using ON/OFF Voltage Start-Up and Vo Rise Characteristic  
Vin=Vin(nom), Full Load

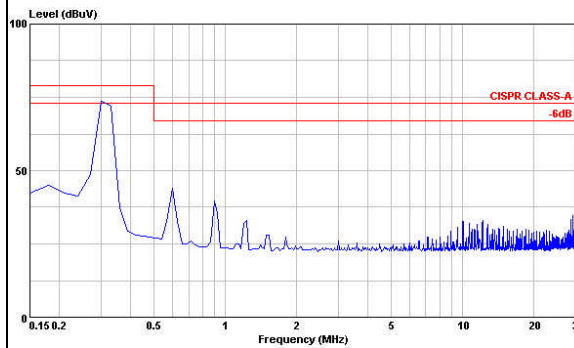

Conduction Emission of EN55022 Class A  
Vin=Vin(nom), Full Load

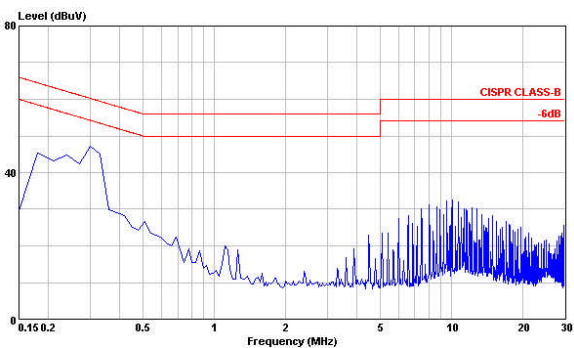

Conduction Emission of EN55022 Class B  
Vin=Vin(nom), Full Load

Characteristic Curves (Continued)

All test conditions are at 25°C. The figures are identical for PXF40-24S05

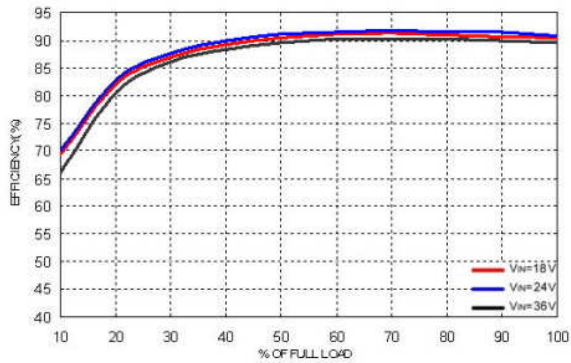

Efficiency Versus Output Current

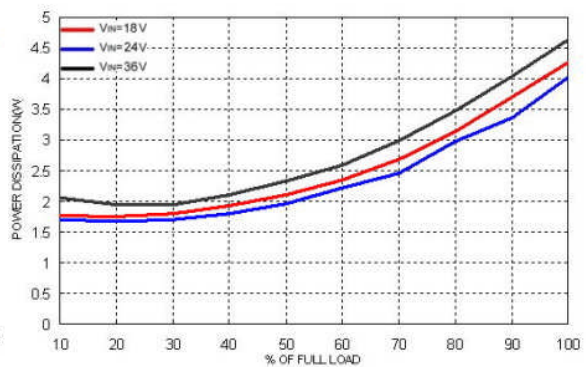

Power Dissipation Versus Output Current

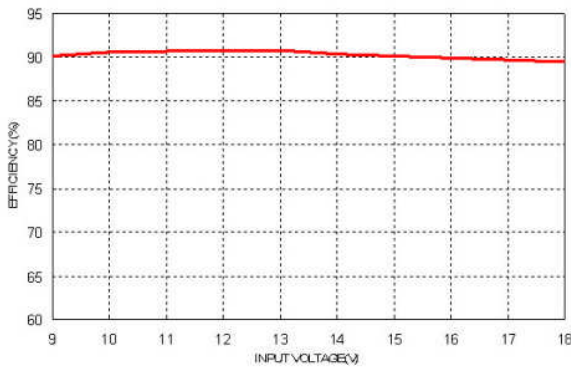

Efficiency Versus Input Voltage. Full Load

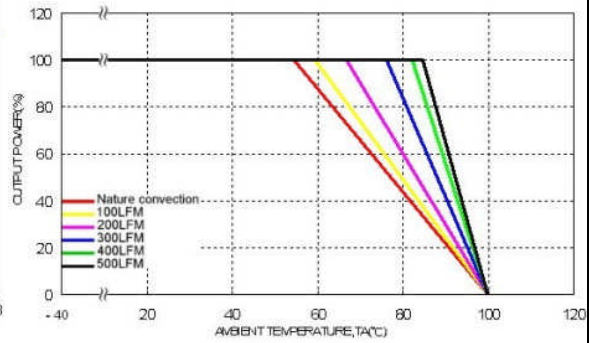

Derating Output Current Versus Ambient Temperature and Airflow  
V<sub>in</sub>=V<sub>in</sub>(nom)

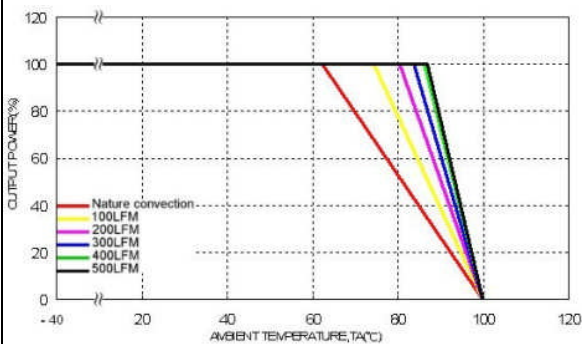

Derating Output Current Versus Ambient Temperature with Heat-Sink  
and Airflow, V<sub>in</sub> = V<sub>in</sub>(nom)



Characteristic Curves (Continued)

All test conditions are at 25°C. The figures are identical for PXF40-24S05

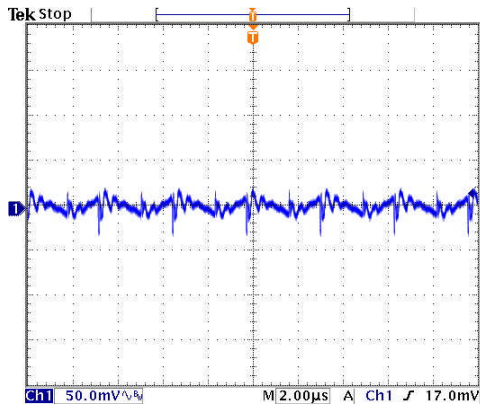

Typical Output Ripple and Noise.  
Vin=Vin(nom), Full Load

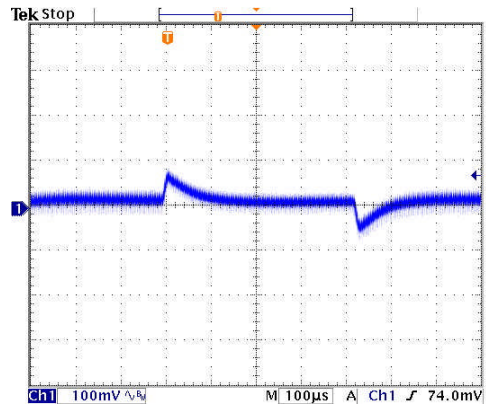

Transient Response to Dynamic Load Change from 100% to 75% to 100% of Full Load ; Vin=Vin(nom)

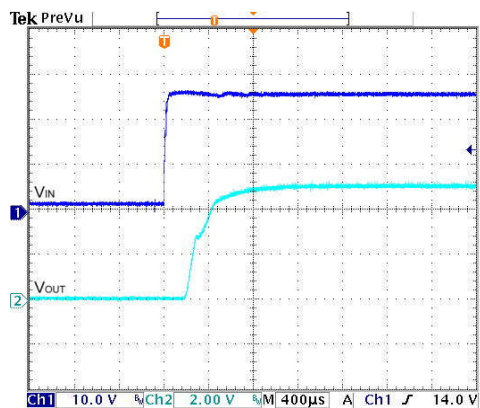

Typical Input Start-Up and Output Rise Characteristic  
Vin=Vin(nom), Full Load

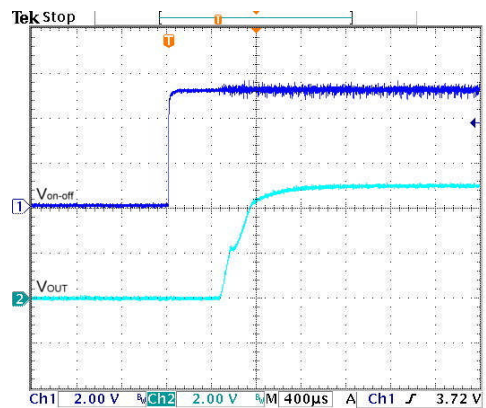

Using ON/OFF Voltage Start-Up and Vo Rise Characteristic  
Vin=Vin(nom), Full Load

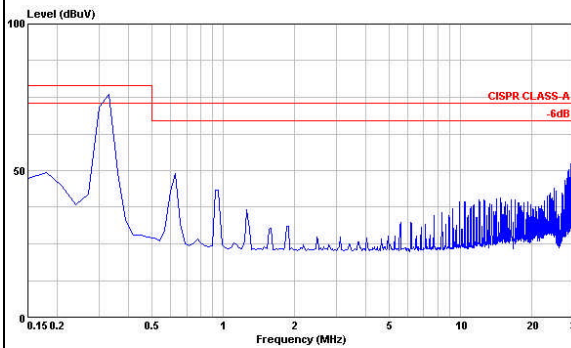

Conduction Emission of EN55022 Class A  
Vin=Vin(nom), Full Load

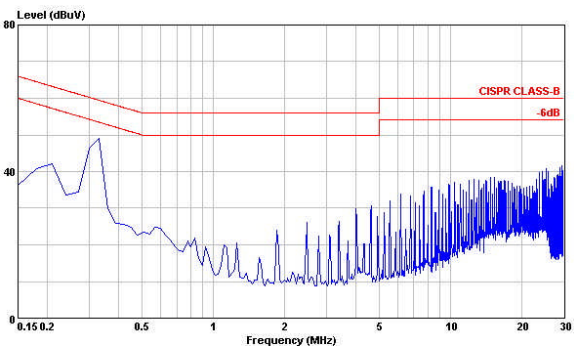

Conduction Emission of EN55022 Class B  
Vin=Vin(nom), Full Load

Characteristic Curves (Continued)

All test conditions are at 25°C. The figures are identical for PXF40-24S12

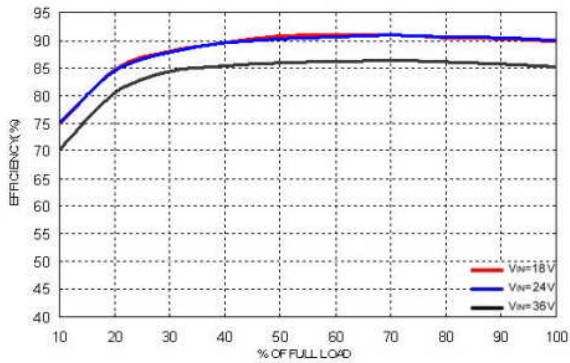

Efficiency Versus Output Current

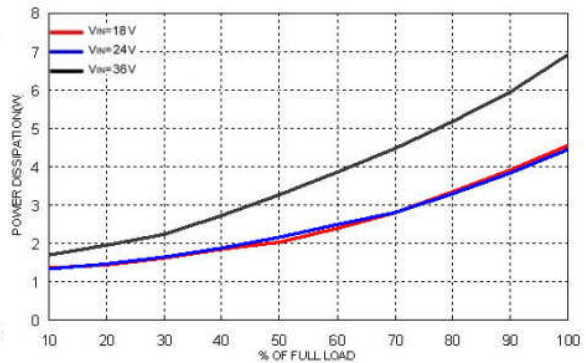

Power Dissipation Versus Output Current

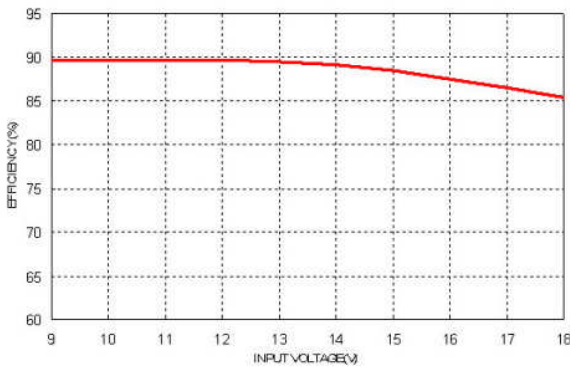

Efficiency Versus Input Voltage. Full Load

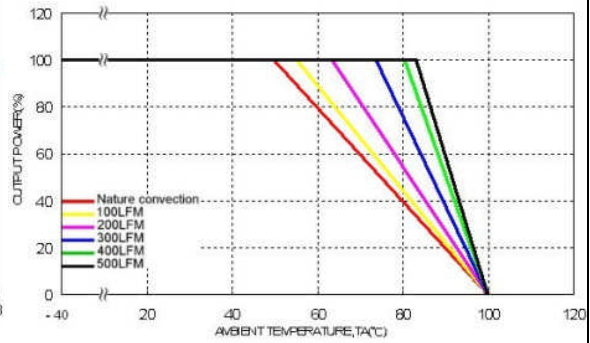

Derating Output Current Versus Ambient Temperature and Airflow  
 $V_{in}=V_{in}(nom)$

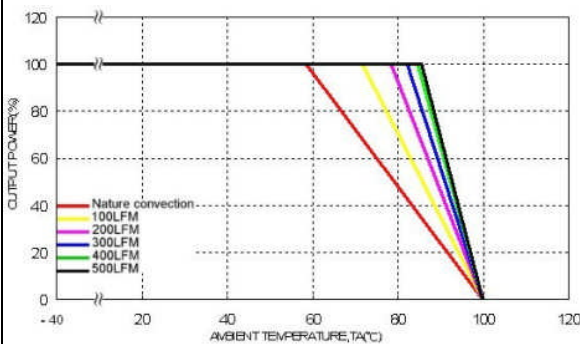

Derating Output Current Versus Ambient Temperature with Heat-Sink  
and Airflow,  $V_{in} = V_{in}(nom)$

Characteristic Curves (Continued)

All test conditions are at 25°C. The figures are identical for PXF40-24S12

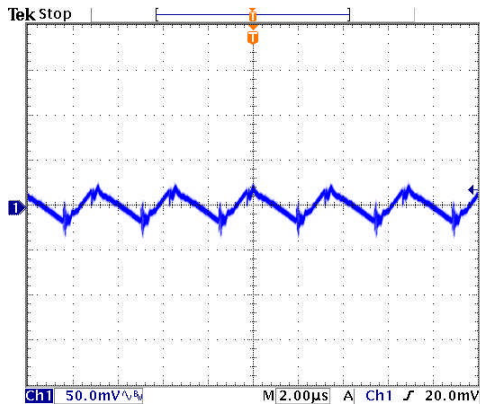

Typical Output Ripple and Noise.  
Vin=Vin(nom), Full Load

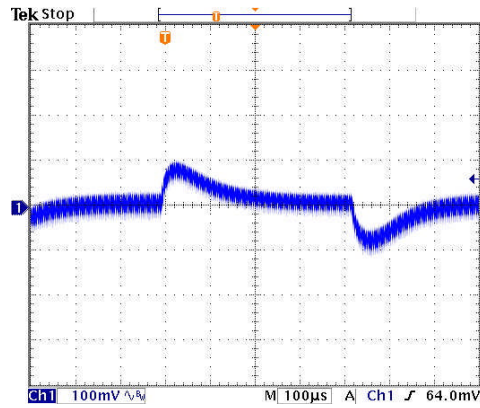

Transient Response to Dynamic Load Change from 100% to 75% to 100% of Full Load ; Vin=Vin(nom)

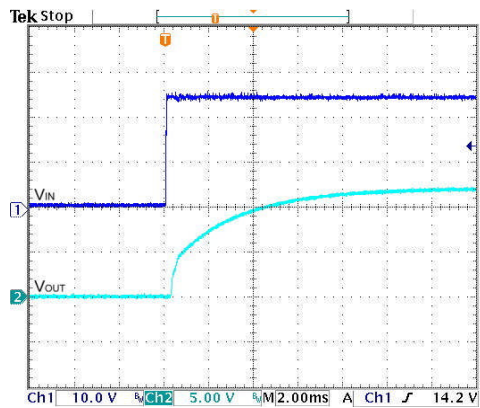

Typical Input Start-Up and Output Rise Characteristic  
Vin=Vin(nom), Full Load

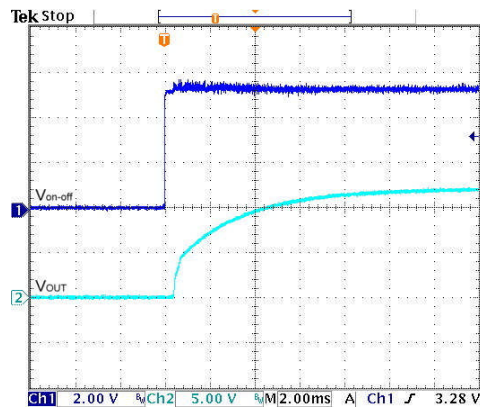

Using ON/OFF Voltage Start-Up and Vo Rise Characteristic  
Vin=Vin(nom), Full Load

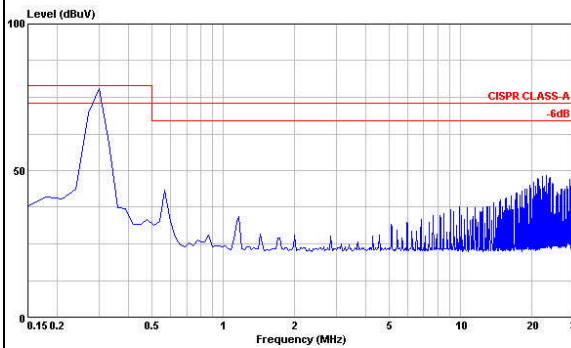

Conduction Emission of EN55022 Class A  
Vin=Vin(nom), Full Load

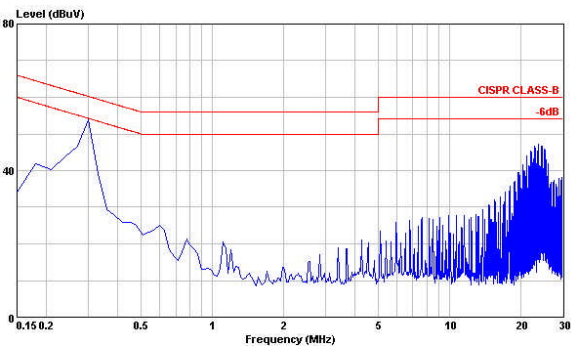

Conduction Emission of EN55022 Class B  
Vin=Vin(nom), Full Load

Characteristic Curves (Continued)

All test conditions are at 25°C. The figures are identical for PXF40-24S15

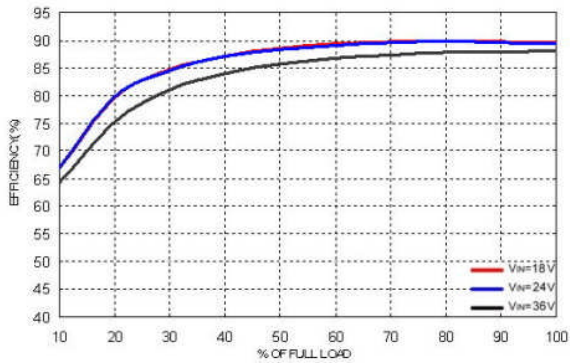

Efficiency Versus Output Current

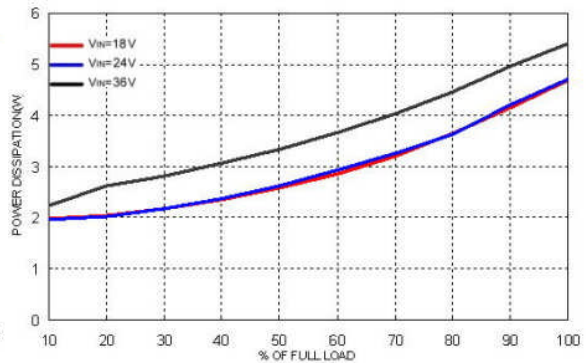

Power Dissipation Versus Output Current

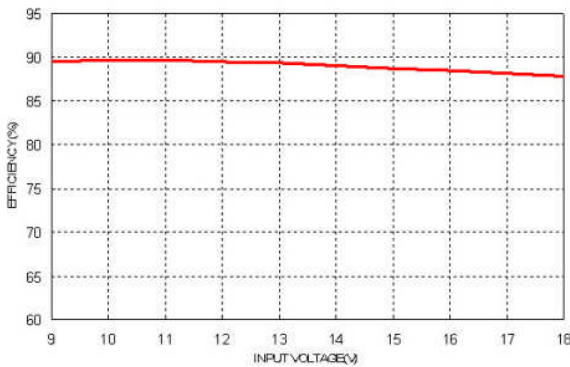

Efficiency Versus Input Voltage. Full Load

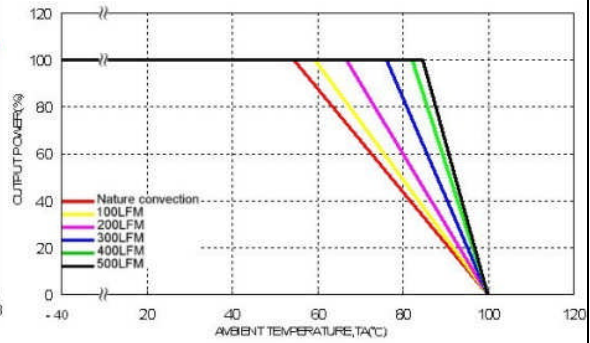

Derating Output Current Versus Ambient Temperature and Airflow  
Vin=Vin(nom)

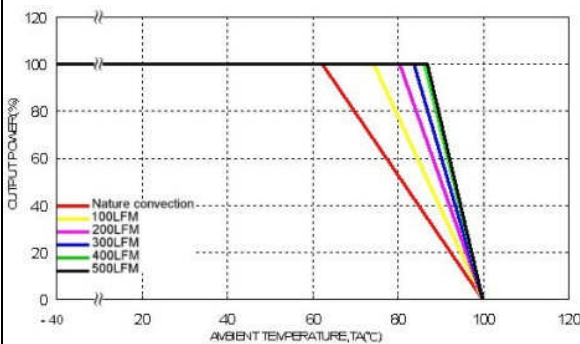

Derating Output Current Versus Ambient Temperature with Heat-Sink  
and Airflow, Vin = Vin(nom)



Characteristic Curves (Continued)

All test conditions are at 25°C. The figures are identical for PXF40-24S15

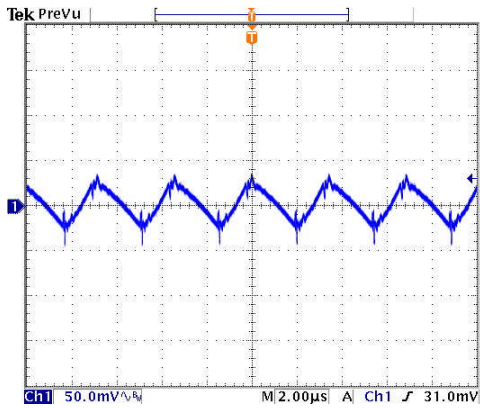

Typical Output Ripple and Noise.  
Vin=Vin(nom), Full Load

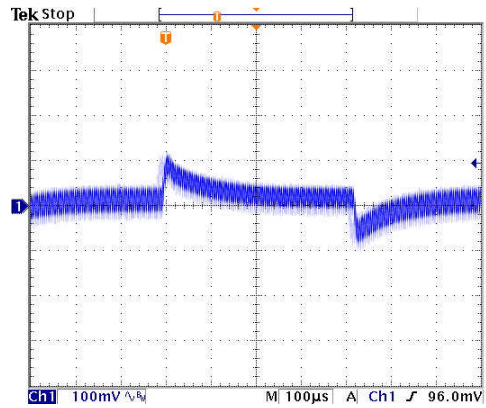

Transient Response to Dynamic Load Change from 100% to 75% to 100% of Full Load ; Vin=Vin(nom)

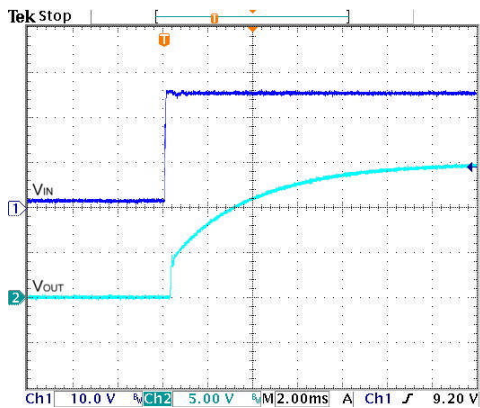

Typical Input Start-Up and Output Rise Characteristic  
Vin=Vin(nom), Full Load

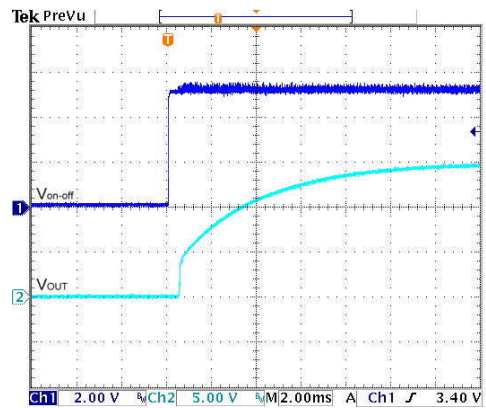

Using ON/OFF Voltage Start-Up and Vo Rise Characteristic  
Vin=Vin(nom), Full Load

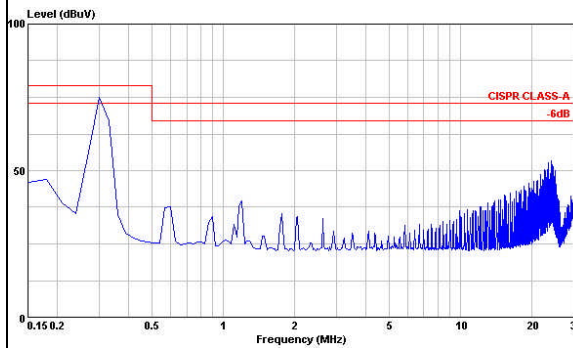

Conduction Emission of EN55022 Class A  
Vin=Vin(nom), Full Load

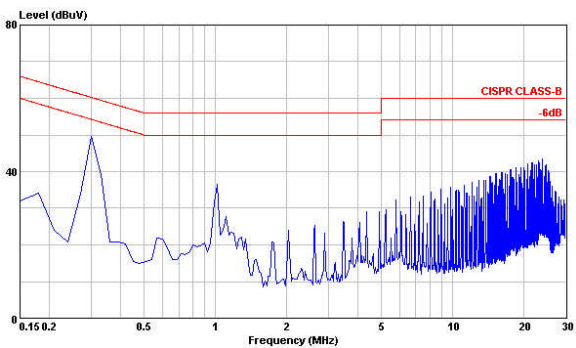

Conduction Emission of EN55022 Class B  
Vin=Vin(nom), Full Load

Characteristic Curves (Continued)

All test conditions are at 25°C. The figures are identical for PXF40-48S1P5 **PRODUCT NOT AVAILABLE**

Efficiency Versus Output Current

Power Dissipation Versus Output Current

Efficiency Versus Input Voltage. Full Load

Derating Output Current Versus Ambient Temperature and Airflow  
 $V_{in} = V_{in(nom)}$

Derating Output Current Versus Ambient Temperature with Heat-Sink  
and Airflow,  $V_{in} = V_{in(nom)}$

Characteristic Curves (Continued)

All test conditions are at 25°C. The figures are identical for PXF40-48S1P5 **PRODUCT NOT AVAILABLE**

Typical Output Ripple and Noise.  
Vin=Vin(nom), Full Load

Transient Response to Dynamic Load Change from  
100% to 75% to 100% of Full Load ; Vin=Vin(nom)

Typical Input Start-Up and Output Rise Characteristic  
Vin=Vin(nom), Full Load

Using ON/OFF Voltage Start-Up and Vo Rise Characteristic  
Vin=Vin(nom), Full Load

Conduction Emission of EN55022 Class A  
Vin=Vin(nom), Full Load

Conduction Emission of EN55022 Class B  
Vin=Vin(nom), Full Load

Characteristic Curves (Continued)

All test conditions are at 25°C. The figures are identical for PXF40-48S1P8 **PRODUCT NOT AVAILABLE**

Efficiency Versus Output Current

Power Dissipation Versus Output Current

Efficiency Versus Input Voltage. Full Load

Derating Output Current Versus Ambient Temperature and Airflow  
 $V_{in} = V_{in(nom)}$

Derating Output Current Versus Ambient Temperature with Heat-Sink  
and Airflow,  $V_{in} = V_{in(nom)}$



Characteristic Curves (Continued)

All test conditions are at 25°C. The figures are identical for PXF40-48S1P8 **PRODUCT NOT AVAILABLE**

Typical Output Ripple and Noise.  
Vin=Vin(nom), Full Load

Transient Response to Dynamic Load Change from  
100% to 75% to 100% of Full Load ; Vin=Vin(nom)

Typical Input Start-Up and Output Rise Characteristic  
Vin=Vin(nom), Full Load

Using ON/OFF Voltage Start-Up and Vo Rise Characteristic  
Vin=Vin(nom), Full Load

Conduction Emission of EN55022 Class A  
Vin=Vin(nom), Full Load

Conduction Emission of EN55022 Class B  
Vin=Vin(nom), Full Load

Characteristic Curves (Continued)

All test conditions are at 25°C. The figures are identical for PXF40-48S2P5

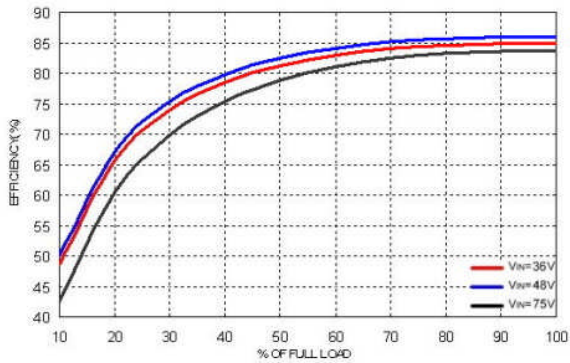

Efficiency Versus Output Current

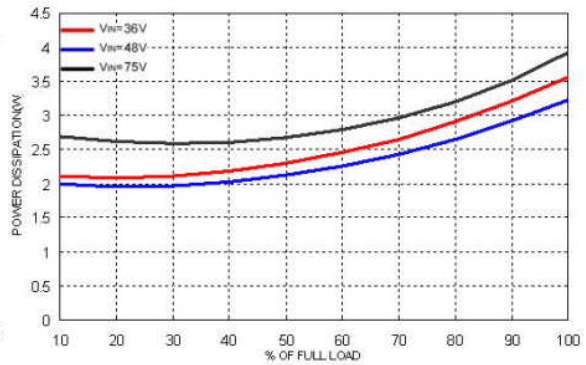

Power Dissipation Versus Output Current

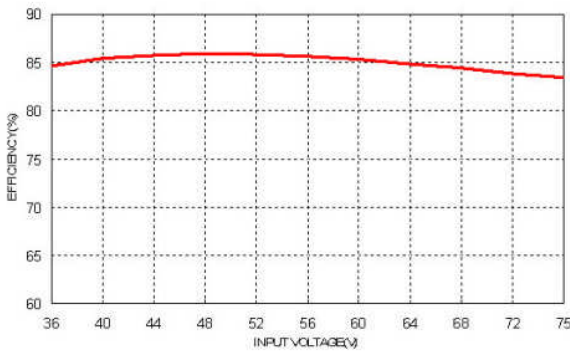

Efficiency Versus Input Voltage, Full Load

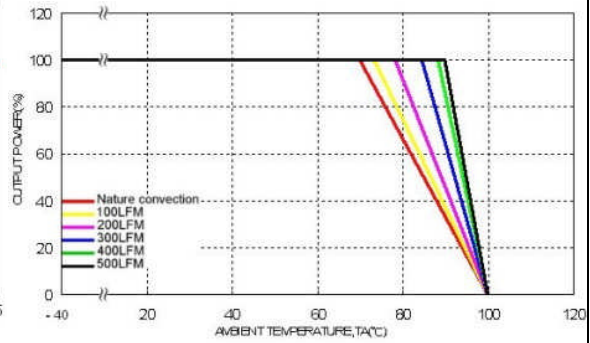

Derating Output Current Versus Ambient Temperature and Airflow  
Vin=Vin(nom)

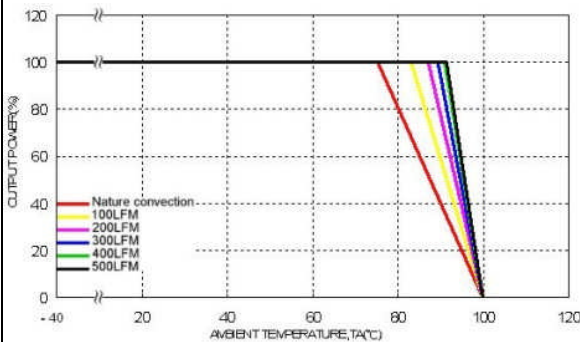

Derating Output Current Versus Ambient Temperature with Heat-Sink  
and Airflow, Vin = Vin(nom)

Characteristic Curves (Continued)

All test conditions are at 25°C. The figures are identical for PXF40-48S2P5

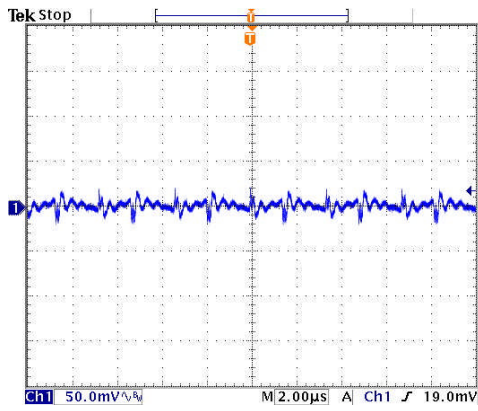

Typical Output Ripple and Noise.  
Vin=Vin(nom), Full Load

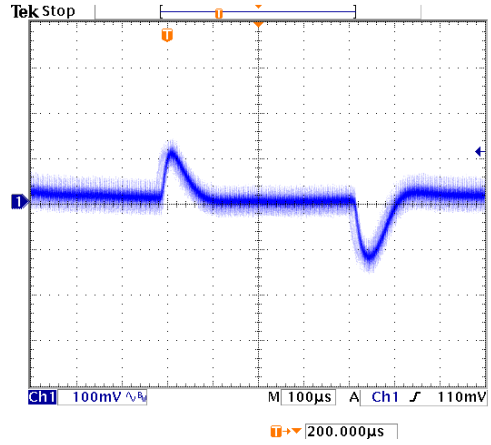

Transient Response to Dynamic Load Change from 100% to 75% to 100% of Full Load ; Vin=Vin(nom)

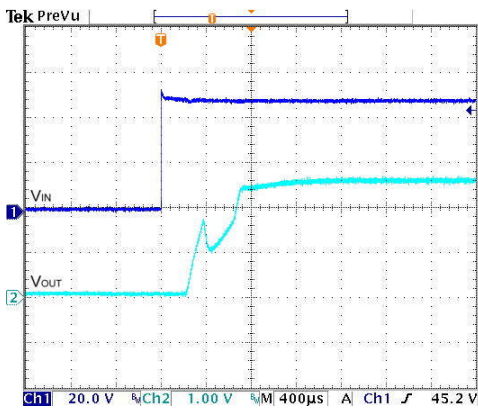

Typical Input Start-Up and Output Rise Characteristic  
Vin=Vin(nom), Full Load

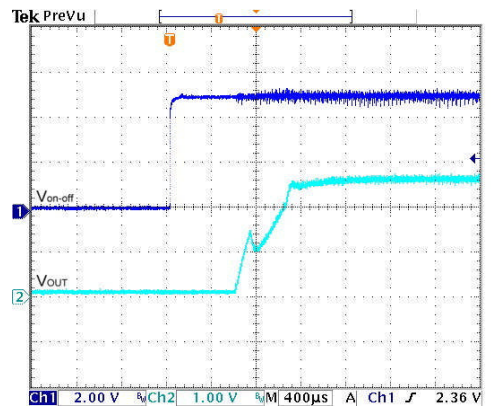

Using ON/OFF Voltage Start-Up and Vo Rise Characteristic  
Vin=Vin(nom), Full Load

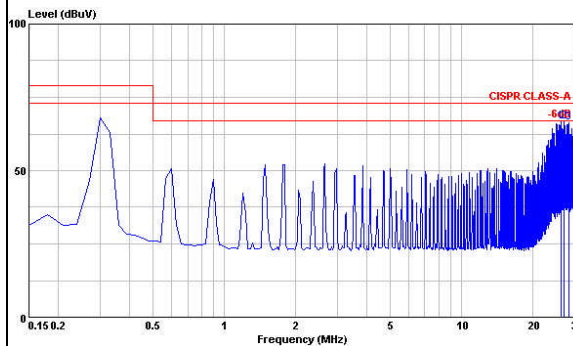

Conduction Emission of EN55022 Class A  
Vin=Vin(nom), Full Load

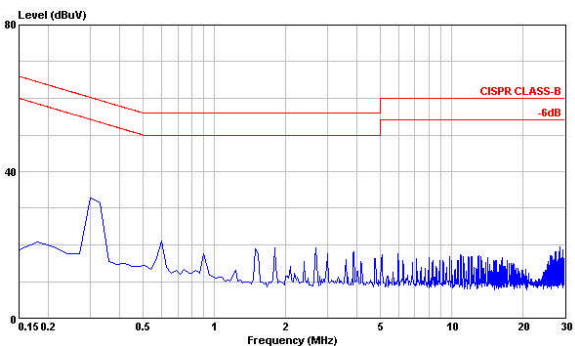

Conduction Emission of EN55022 Class B  
Vin=Vin(nom), Full Load

Characteristic Curves (Continued)

All test conditions are at 25°C. The figures are identical for PXF40-48S3P3

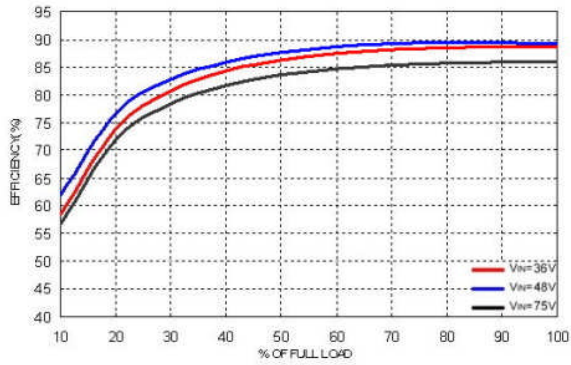

Efficiency Versus Output Current

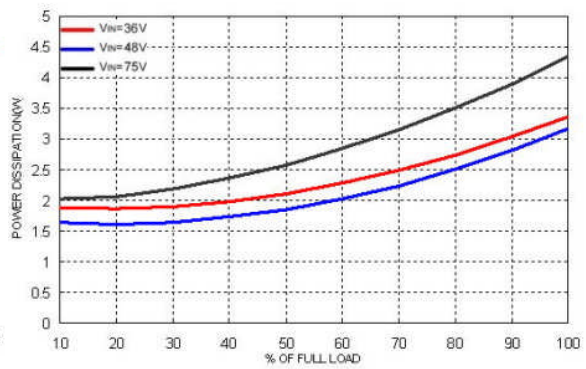

Power Dissipation Versus Output Current

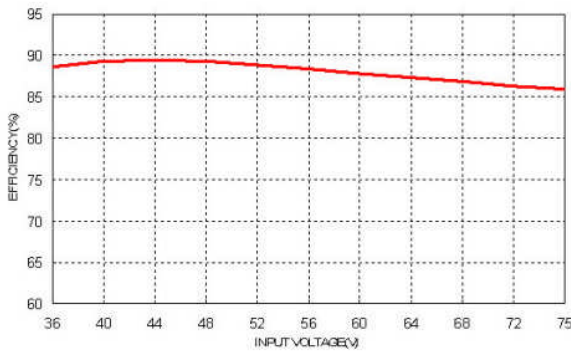

Efficiency Versus Input Voltage. Full Load

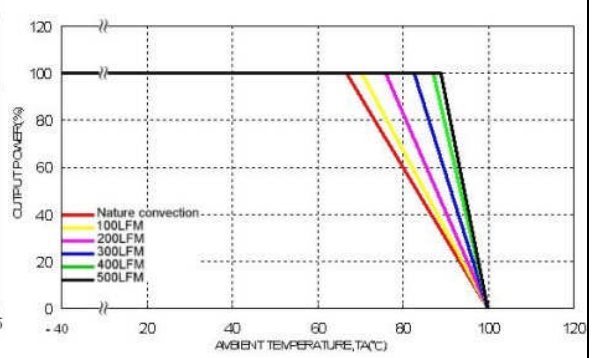

Derating Output Current Versus Ambient Temperature and Airflow  
Vin=Vin(nom)

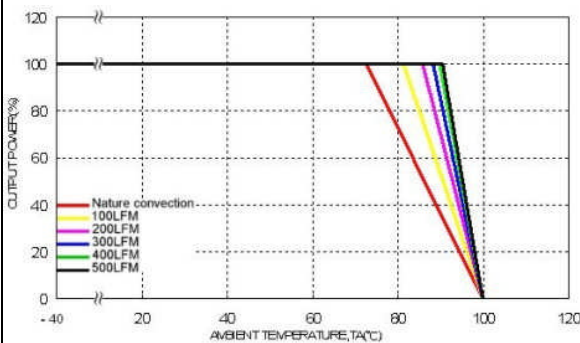

Derating Output Current Versus Ambient Temperature with Heat-Sink  
and Airflow, Vin = Vin(nom)

Characteristic Curves (Continued)

All test conditions are at 25°C. The figures are identical for PXF40-48S3P3

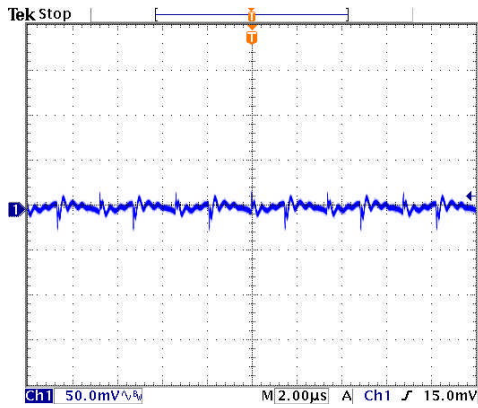

Typical Output Ripple and Noise.  
Vin=Vin(nom), Full Load

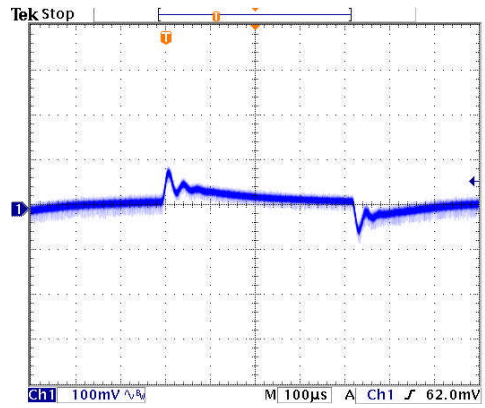

Transient Response to Dynamic Load Change from 100% to 75% to 100% of Full Load ; Vin=Vin(nom)

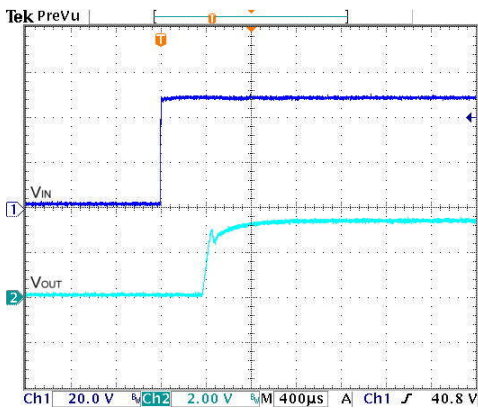

Typical Input Start-Up and Output Rise Characteristic  
Vin=Vin(nom), Full Load

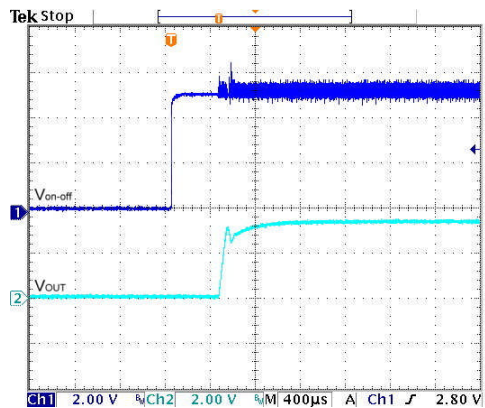

Using ON/OFF Voltage Start-Up and Vo Rise Characteristic  
Vin=Vin(nom), Full Load

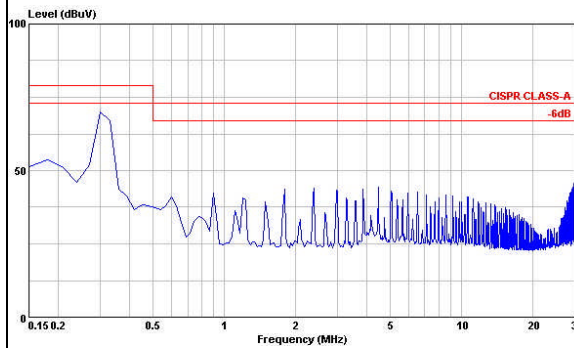

Conduction Emission of EN55022 Class A  
Vin=Vin(nom), Full Load

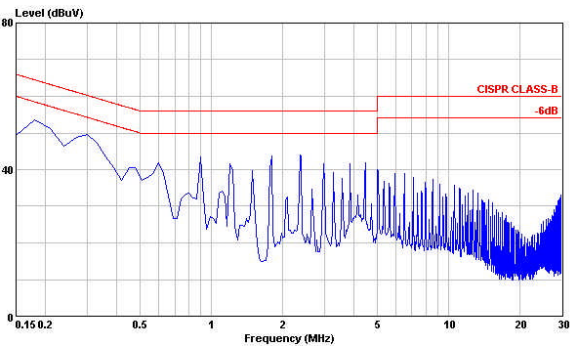

Conduction Emission of EN55022 Class B  
Vin=Vin(nom), Full Load



Characteristic Curves (Continued)

All test conditions are at 25°C. The figures are identical for PXF40-48S05

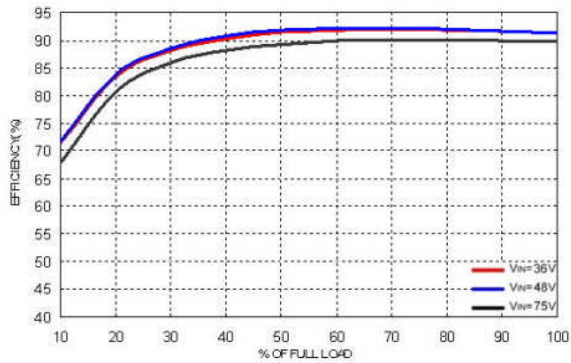

Efficiency Versus Output Current

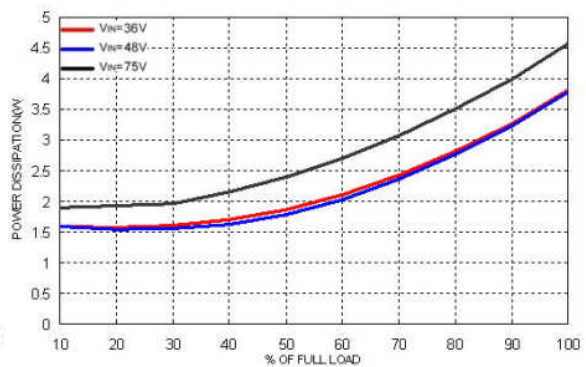

Power Dissipation Versus Output Current

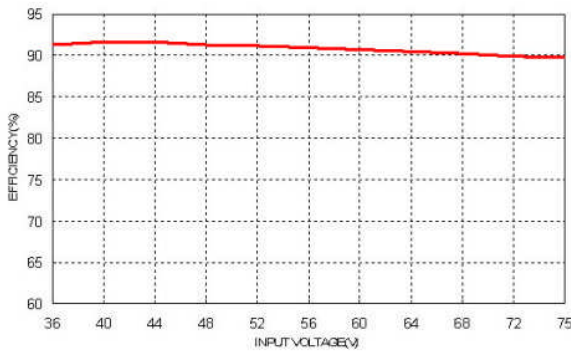

Efficiency Versus Input Voltage. Full Load

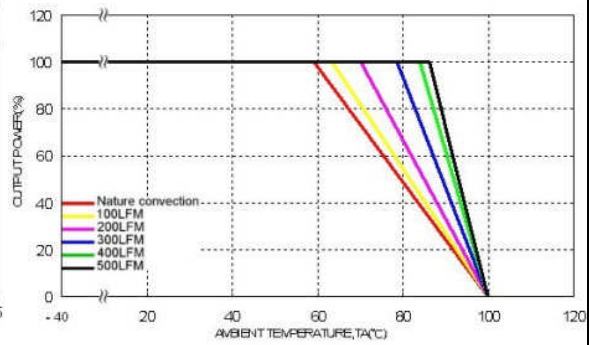

Derating Output Current Versus Ambient Temperature and Airflow  
Vin=Vin(nom)

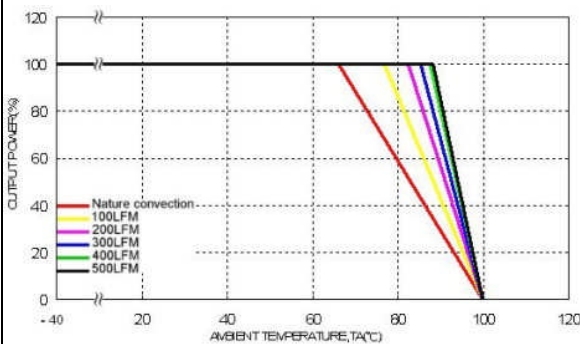

Derating Output Current Versus Ambient Temperature with Heat-Sink  
and Airflow, Vin = Vin(nom)

Characteristic Curves (Continued)

All test conditions are at 25°C. The figures are identical for PXF40-48S05

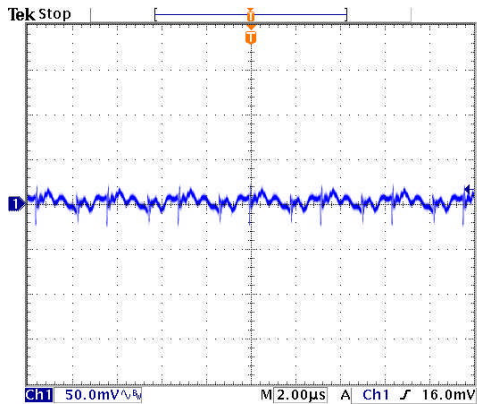

Typical Output Ripple and Noise.  
Vin=Vin(nom), Full Load

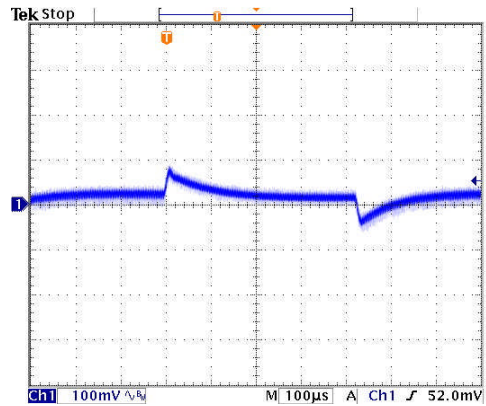

Transient Response to Dynamic Load Change from 100% to 75% to 100% of Full Load ; Vin=Vin(nom)

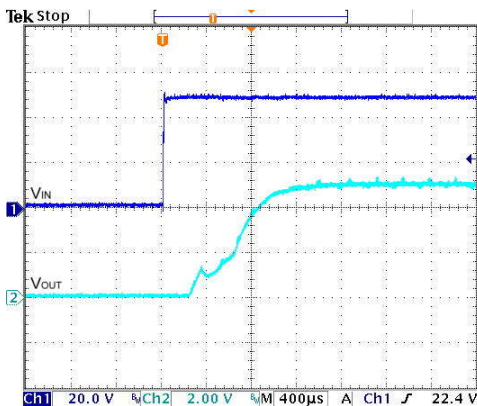

Typical Input Start-Up and Output Rise Characteristic  
Vin=Vin(nom), Full Load

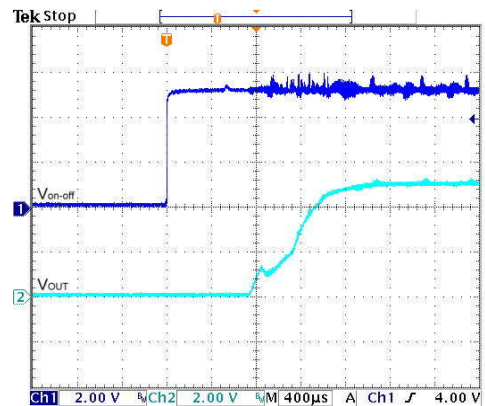

Using ON/OFF Voltage Start-Up and Vo Rise Characteristic  
Vin=Vin(nom), Full Load

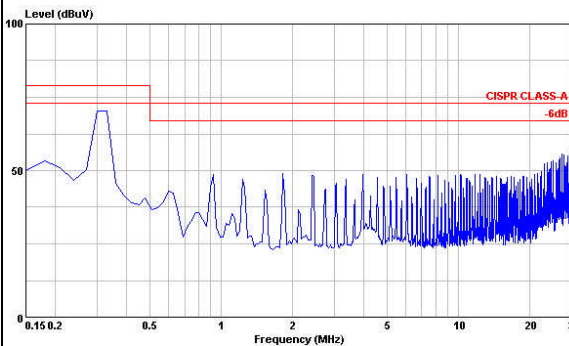

Conduction Emission of EN55022 Class A  
Vin=Vin(nom), Full Load

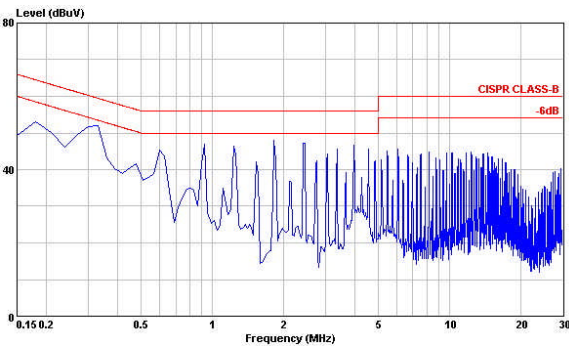

Conduction Emission of EN55022 Class B  
Vin=Vin(nom), Full Load

Characteristic Curves (Continued)

All test conditions are at 25°C. The figures are identical for PXF40-48S12

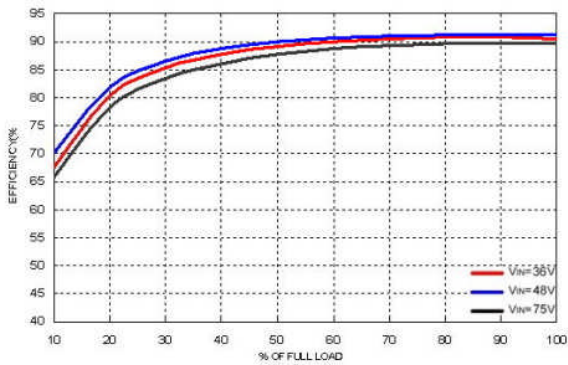

Efficiency Versus Output Current

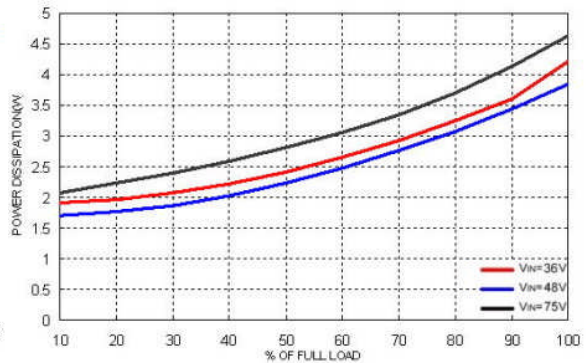

Power Dissipation Versus Output Current

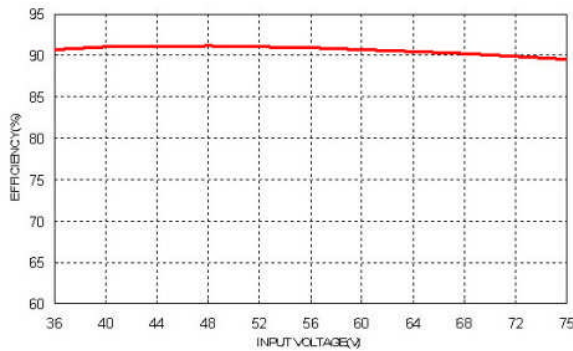

Efficiency Versus Input Voltage. Full Load

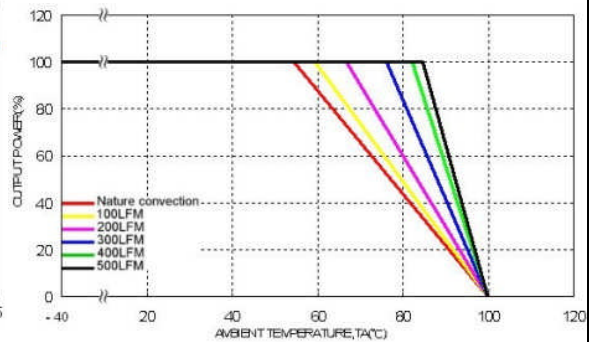

Derating Output Current Versus Ambient Temperature and Airflow  
Vin=Vin(nom)

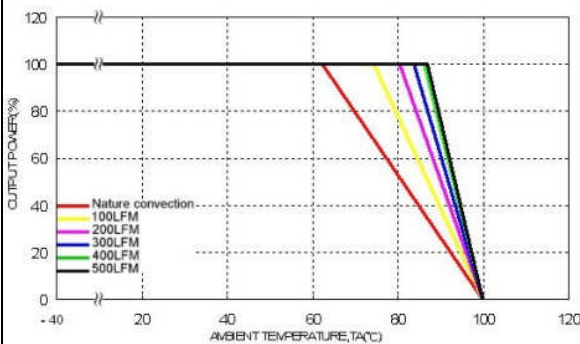

Derating Output Current Versus Ambient Temperature with Heat-Sink  
and Airflow, Vin = Vin(nom)



Characteristic Curves (Continued)

All test conditions are at 25°C. The figures are identical for PXF40-48S12

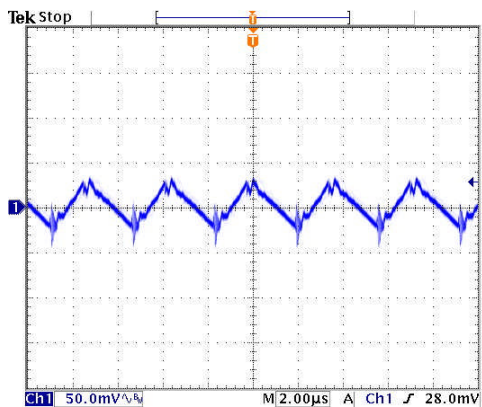

Typical Output Ripple and Noise.  
Vin=Vin(nom), Full Load

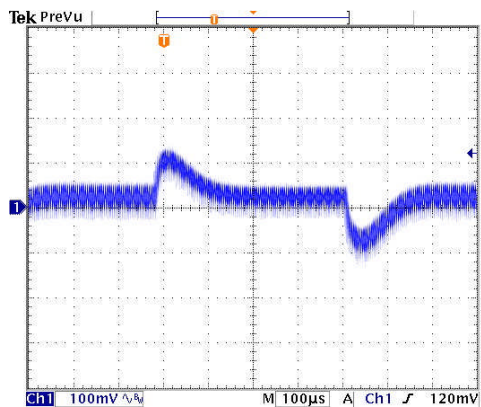

Transient Response to Dynamic Load Change from 100% to 75% to 100% of Full Load ; Vin=Vin(nom)

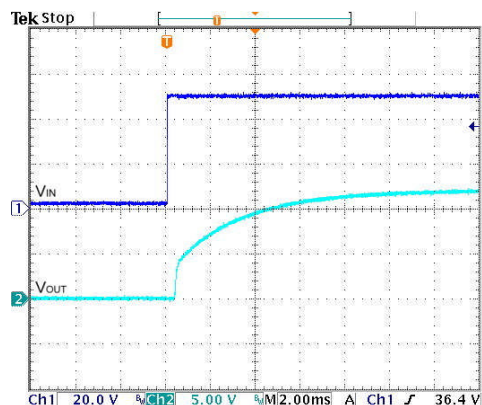

Typical Input Start-Up and Output Rise Characteristic  
Vin=Vin(nom), Full Load

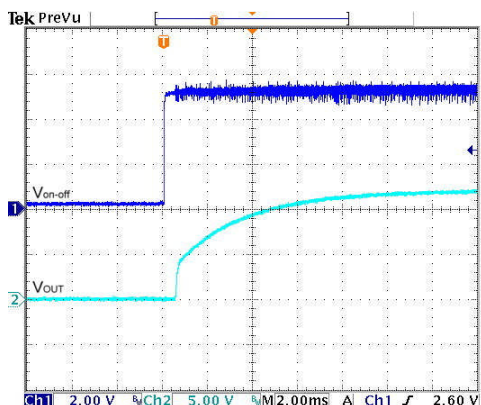

Using ON/OFF Voltage Start-Up and Vo Rise Characteristic  
Vin=Vin(nom), Full Load

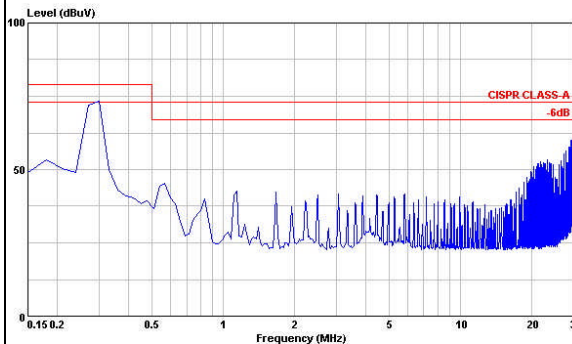

Conduction Emission of EN55022 Class A  
Vin=Vin(nom), Full Load

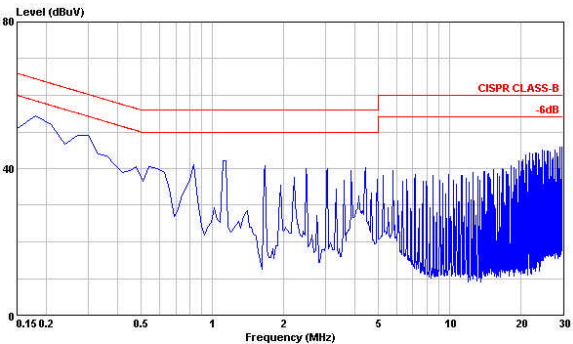

Conduction Emission of EN55022 Class B  
Vin=Vin(nom), Full Load

Characteristic Curves (Continued)

All test conditions are at 25°C. The figures are identical for PXF40-48S15

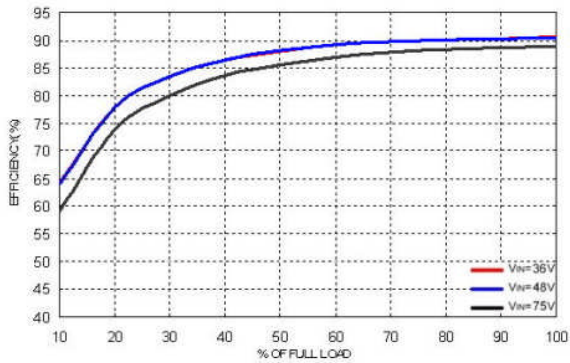

Efficiency Versus Output Current

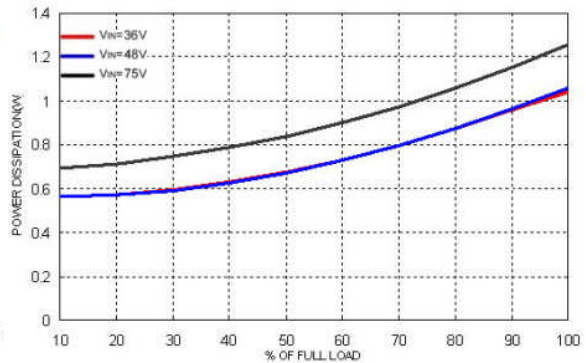

Power Dissipation Versus Output Current

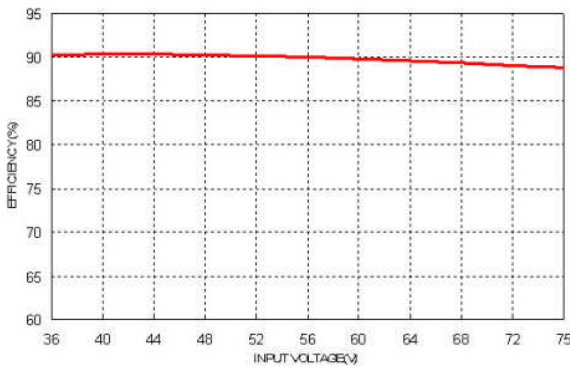

Efficiency Versus Input Voltage. Full Load

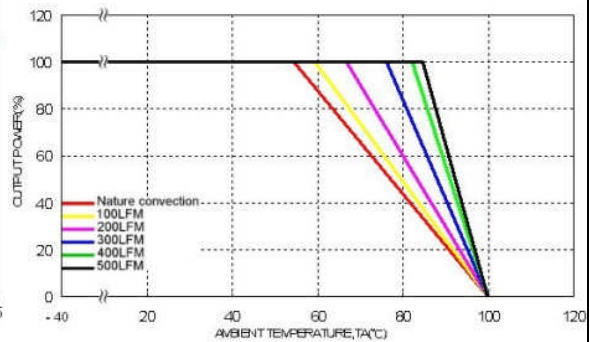

Derating Output Current Versus Ambient Temperature and Airflow  
Vin=Vin(nom)

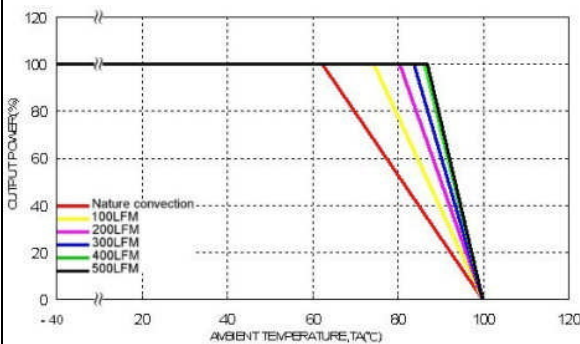

Derating Output Current Versus Ambient Temperature with Heat-Sink  
and Airflow, Vin = Vin(nom)

Characteristic Curves (Continued)

All test conditions are at 25°C. The figures are identical for PXF40-48S15

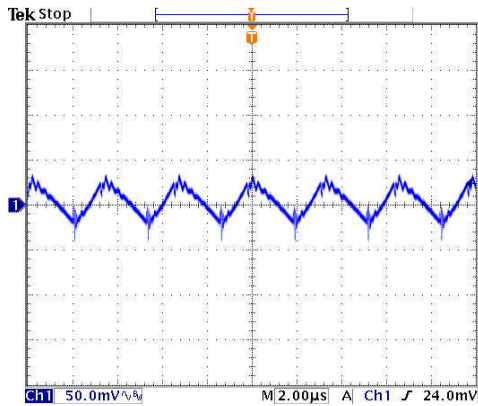

Typical Output Ripple and Noise.  
Vin=Vin(nom), Full Load

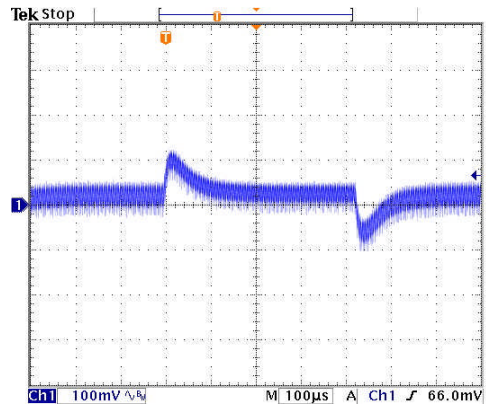

Transient Response to Dynamic Load Change from 100% to 75% to 100% of Full Load ; Vin=Vin(nom)

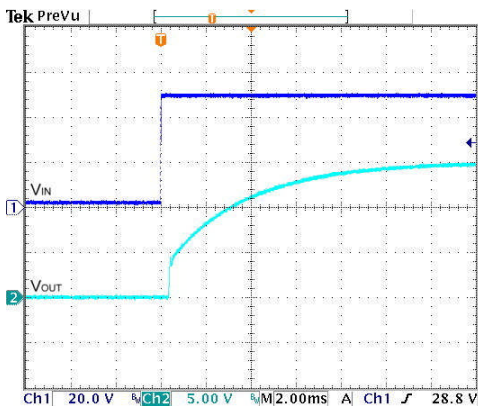

Typical Input Start-Up and Output Rise Characteristic  
Vin=Vin(nom), Full Load

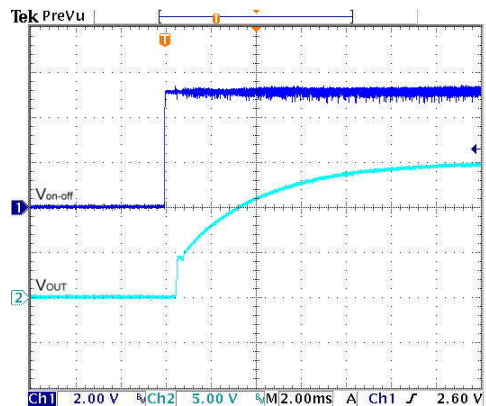

Using ON/OFF Voltage Start-Up and V<sub>o</sub> Rise Characteristic  
Vin=Vin(nom), Full Load

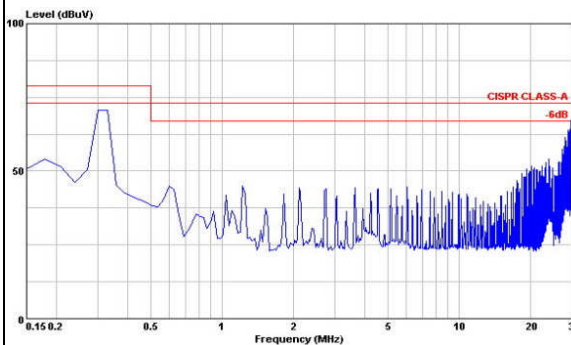

Conduction Emission of EN55022 Class A  
Vin=Vin(nom), Full Load

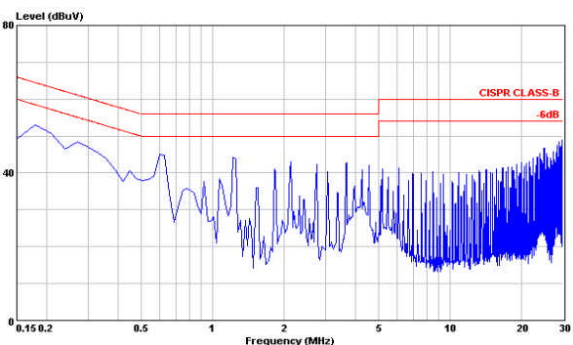

Conduction Emission of EN55022 Class B  
Vin=Vin(nom), Full Load

**Test Configurations**

**Input reflected-ripple current measurement test:**

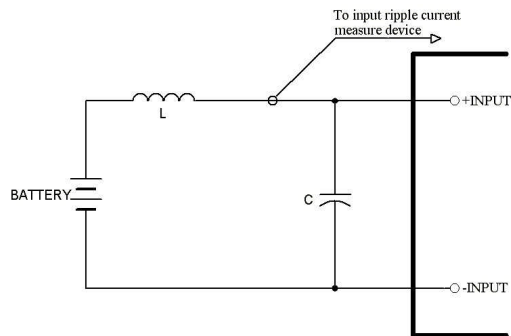

Component	Value	Voltage	Reference
L	12μH	---	---
C	220μF	100V	Aluminum Electrolytic Capacitor

**Peak-to-peak output ripple & noise measurement test:**

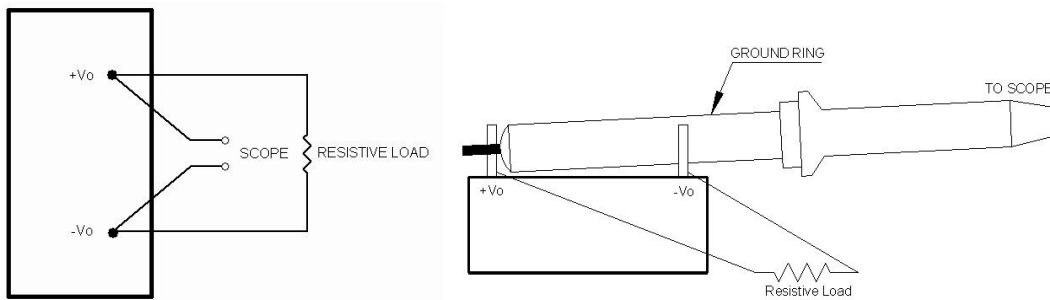

**Output voltage and efficiency measurement test**

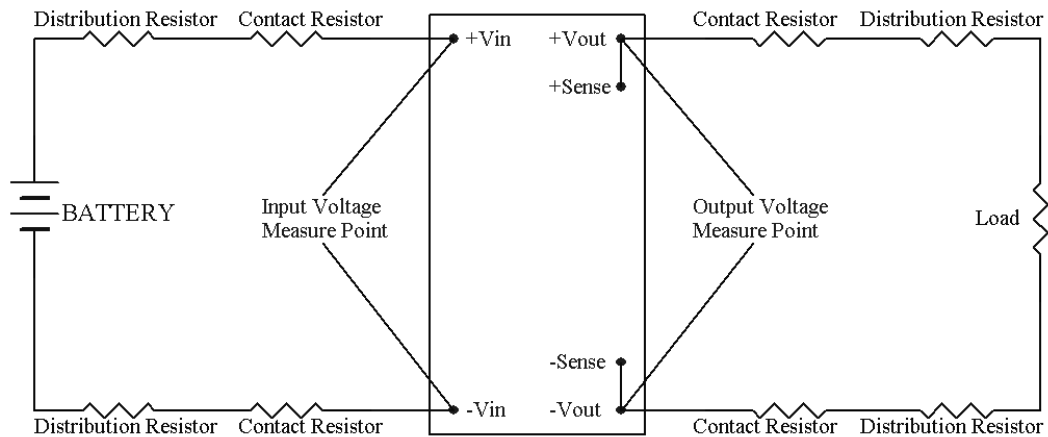

Note: All measurements are taken at the module terminals.

$$Efficiency = \left( \frac{V_o \times I_o}{V_{in} \times I_{in}} \right) \times 100\%$$

EMC Considerations

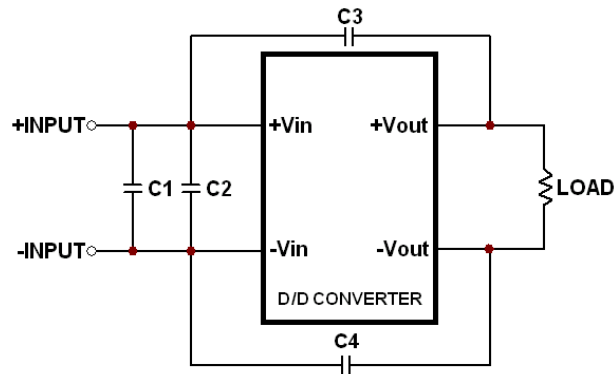

Suggested Schematic for EN55022 Conducted Emission Class A Limits

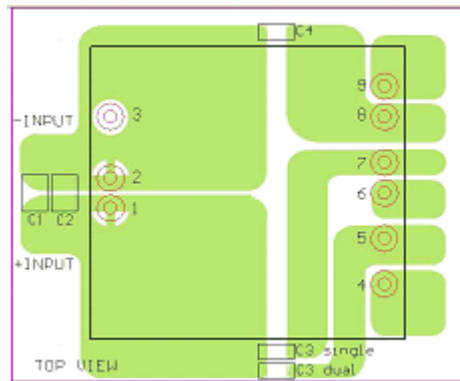

Recommended Layout with Input Filter

To meet conducted emissions EN55022 CLASS A needed the following components :

PXF40-12Sxx

Component	Value	Voltage	Reference
C1	6.8uF	50V	1812 MLCC
C3,C4	1000pF	2KV	1808 MLCC

PXF40-24Sxx

Component	Value	Voltage	Reference
C1	6.8uF	50V	1812 MLCC
C3,C4	1000pF	2KV	1808 MLCC

PXF40-48Sxx

Component	Value	Voltage	Reference
C1	2.2uF	100V	1812 MLCC
C3,C4	1000pF	2KV	1808 MLCC

EMC Considerations (Continued)

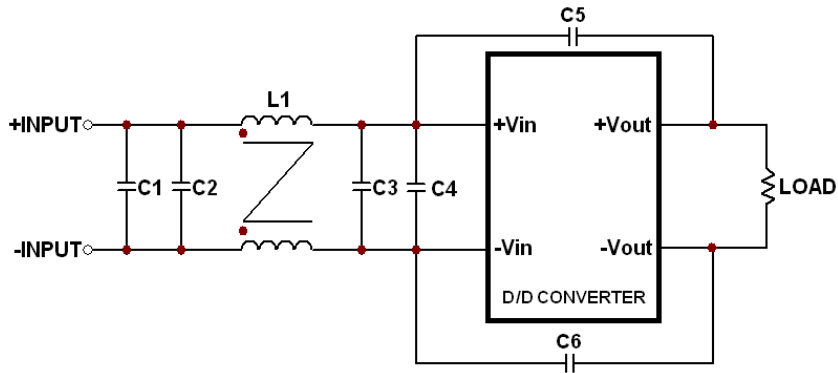

Suggested Schematic for EN55022 Conducted Emission Class B Limits

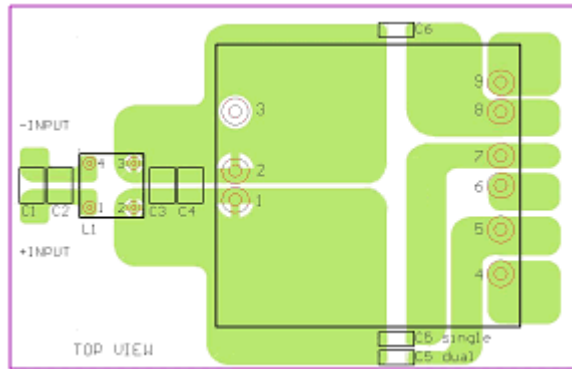

Recommended Layout with Input Filter

To meet conducted emissions EN55022 CLASS B needed the following components:

PXF40-12Sxx

Component	Value	Voltage	Reference
C1,C3	4.7uF	50V	1812 MLCC
C5,C6	1000pF	2KV	1808 MLCC
L1	450uH	----	Common Choke

PXF40-24Sxx

Component	Value	Voltage	Reference
C1,C3	6.8uF	50V	1812 MLCC
C5,C6	1000pF	2KV	1808 MLCC
L1	450uH	----	Common Choke

PXF40-48Sxx

Component	Value	Voltage	Reference
C1,C2	2.2uF	100V	1812 MLCC
C3,C4	2.2uF	100V	1812 MLCC
C5,C6	1000pF	2KV	1808 MLCC
L1	830uH	----	Common Choke

## EMC Considerations (Continued)

This Common Choke L1 has been define as follows:

- L1: 450 $\mu$ H $\pm$ 35% / DCR: 25m $\Omega$ , max  
A height: 9.8 mm, Max
- L1: 830 $\mu$ H $\pm$ 35% / DCR: 31m $\Omega$ , max  
A height: 8.8 mm, Max
- Test condition: 100KHz / 100mV
- Recommended through hole:  $\Phi$ 0.8mm
- All dimensions in millimeters

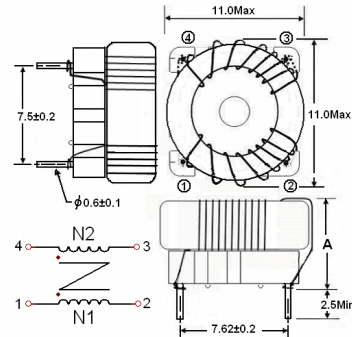

## Input Source Impedance

The converter should be connected to a low impedance input source. Highly inductive source impedance can affect the stability of the converter. An input external L-C filter is recommended to minimize input reflected ripple current. The inductor has a simulated source impedance of 12 $\mu$ H and the capacitor is Nippon chemi-con KY series 220 $\mu$ F/100V. The capacitor must be located as close as possible to the input terminals of the converter for lowest impedance.

## Output Over Current Protection

When excessive output currents occur in the system, circuit protection is required on all converters. Normally, overload current is maintained at approximately 150 percent of rated current for PXF40-xxSxx series.

Hiccup-mode is a method of operation in a converter whose purpose is to protect the power supply from being damaged during an over-current fault condition. It also enables the converter to restart when the fault is removed. There are other ways of protecting the converter when it is over-loaded, such as the maximum current limiting or current foldback methods.

One of the problems resulting from over current is that excessive heat may be generated in power devices; especially MOSFET and Schottky diodes and the temperature of these devices may exceed their specified limits. A protection mechanism has to be used to prevent these power devices from being damaged.

The operation of hiccup is as follows. When the current sense circuit sees an over-current event, the controller shuts off the converter for a given time and then tries to start up the converter again. If the over-load condition has been removed, the converter will start up and operate normally; otherwise, the controller will see another over-current event and will shut off the converter again, repeating the previous cycle. Hiccup operation has none of the drawbacks of the other two protection methods, although its circuit is more complicated because it requires a timing circuit. The excess heat due to overload lasts for only a short duration in the hiccup cycle, hence the junction temperature of the power devices is much lower.

### Output Over Voltage Protection

The output over-voltage protection consists of an output Zener diode that monitors the voltage on the output terminals. If the voltage on the output terminals exceeds the over-voltage protection threshold, then the Zener diode clamps the output voltage.

### Short Circuitry Protection

Continuous, hiccup and auto-recovery mode.

During a short circuit the converter shuts down. The average current during this condition will be very low .

### Thermal Consideration

The converter operates in a variety of thermal environments. However, sufficient cooling should be provided to help ensure reliable operation of the unit. Heat is removed by conduction, convection, and radiation to the surrounding environment. Proper cooling can be verified by measuring the point as shown in the figure below. The temperature at this location should not exceed 100°C. When operating, adequate cooling must be provided to maintain the test point temperature at or below 100°C. Although the maximum point temperature of the converter is 100°C, limiting this temperature to a lower value will increase the reliability of the unit.

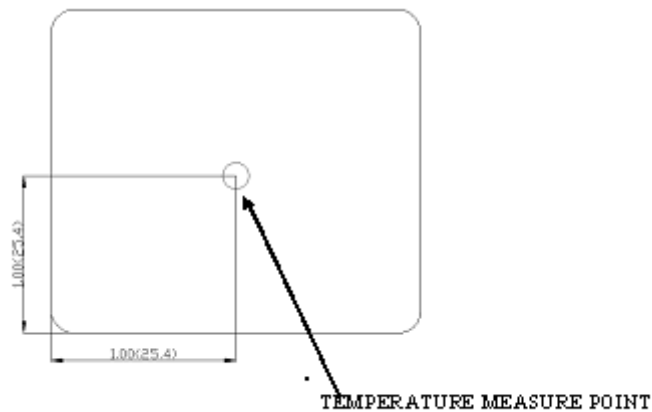



### Heat Sink Consideration

2.00(50.8)

2.00(50.8)

0.67(17.0) MAX

2.20(56.0) MAX

All dimensions in millimeters

Use heat-sink (7G-0026A) for lowering temperature and higher reliability of the module.

Remote ON/OFF Control

The Remote ON/OFF Pin is used to turn on and off the DC-DC converter. The user must use a switch to control the logic voltage (high or low level) of the ON/OFF pin, referenced to  $V_i (-)$ . The switch can be open collector transistor, FET, or Opto-Coupler that is capable of sinking up to 0.5 mA at a low-level logic Voltage. For High-level logic of the ON/OFF signal (maximum voltage): the allowable leakage current of the switch at 12V is 0.5 mA.

Remote ON/OFF Implementation Circuits

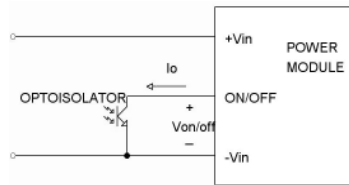

Isolated-Closure Remote ON/OFF

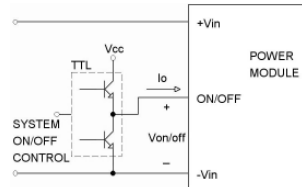

Level Control Using TTL Output

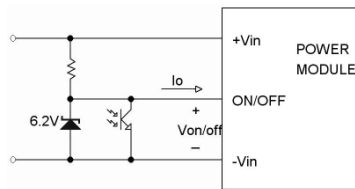

Level Control Using Line Voltage

Positive logic:

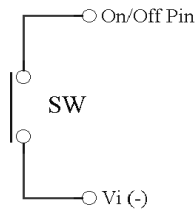

When FEC40 module is turned off at Low-level logic

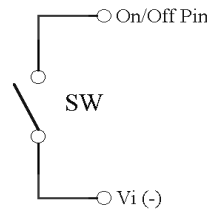

When FEC40 module is turned on at High-level logic

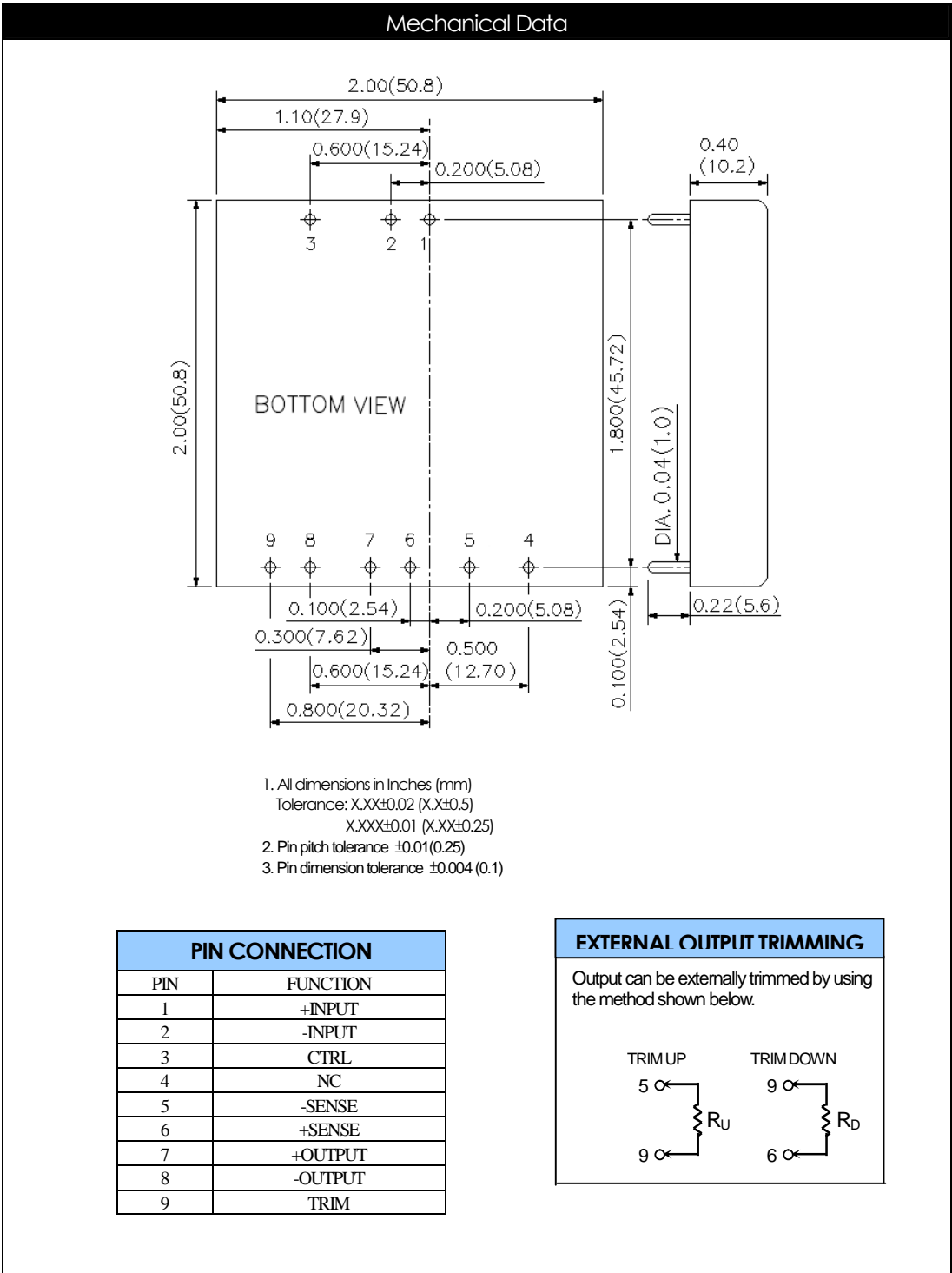

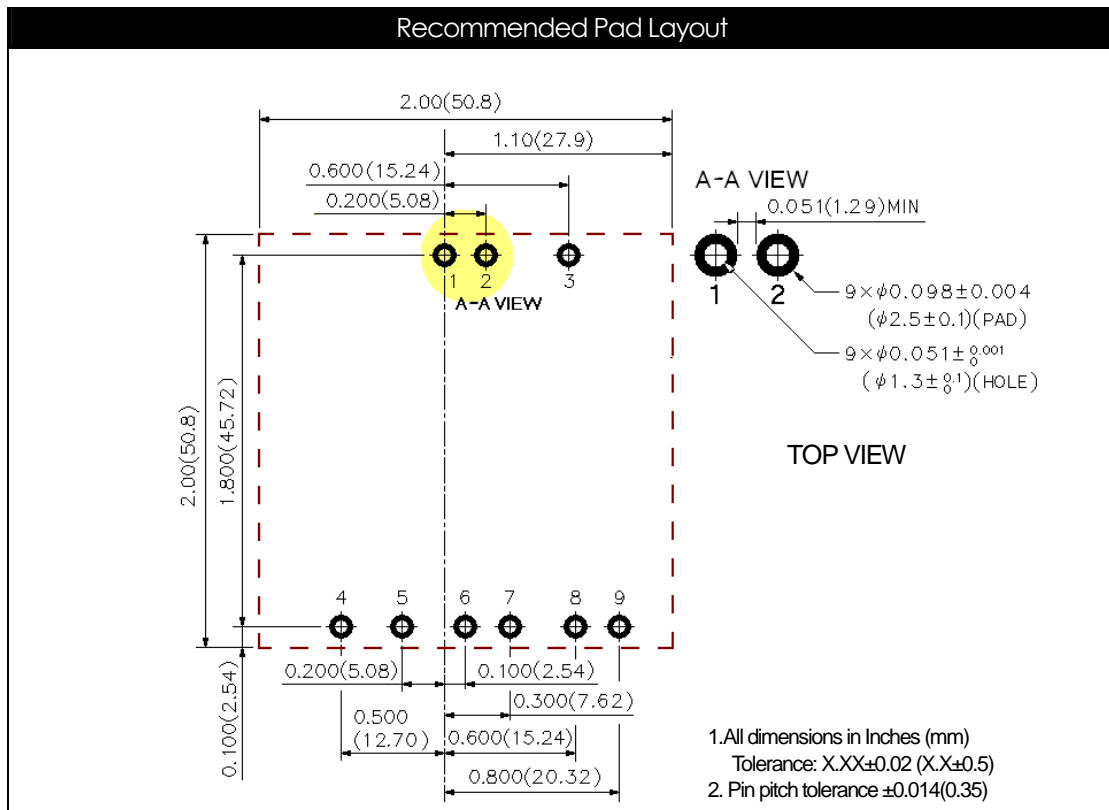

Output Voltage Adjustment

Output voltage set point adjustment allows the user to increase or decrease the output voltage set point of a module. This is accomplished by connecting an external resistor between the TRIM pin and either the SENSE(+) or SENSE(-) pins. With an external resistor between the TRIM and SENSE(-) pin, the output voltage set point increases. With an external resistor between the TRIM and SENSE(+) pin, the output voltage set point decreases.

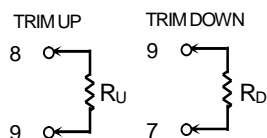

TRIM TABLE

PXF40-xxS1P5

Trim up (%)	1	2	3	4	5	6	7	8	9	10
V <sub>OUT</sub> (Volts)=	1.515	1.53	1.545	1.56	1.575	1.59	1.605	1.62	1.635	1.65
R <sub>U</sub> (K Ohms)=	4.578	2.605	1.227	0.808	0.557	0.389	0.27	0.18	0.11	0.054
Trim down (%)	1	2	3	4	5	6	7	8	9	10
V <sub>OUT</sub> (Volts)=	1.485	1.47	1.455	1.44	1.425	1.41	1.395	1.38	1.365	1.35
R <sub>D</sub> (K Ohms)=	5.704	2.571	1.527	1.005	0.692	0.483	0.334	0.222	0.135	0.065

PXF40-xxS1P8

Trim up (%)	1	2	3	4	5	6	7	8	9	10
V <sub>OUT</sub> (Volts)=	1.818	1.836	1.854	1.872	1.89	1.908	1.926	1.944	1.962	1.98
R <sub>U</sub> (K Ohms)=	11.639	5.205	3.06	1.988	1.344	0.915	0.609	0.379	0.2	0.057
Trim down (%)	1	2	3	4	5	6	7	8	9	10
V <sub>OUT</sub> (Volts)=	1.782	1.764	1.746	1.728	1.71	1.692	1.674	1.656	1.638	1.62
R <sub>D</sub> (K Ohms)=	14.66	6.57	3.874	2.525	1.716	1.177	0.792	0.503	0.278	0.098

PXF40-xxS2P5

Trim up (%)	1	2	3	4	5	6	7	8	9	10
V <sub>OUT</sub> (Volts)=	2.525	2.55	2.575	2.6	2.625	2.65	2.675	2.7	2.725	2.75
R <sub>U</sub> (K Ohms)=	37.076	16.675	9.874	6.474	4.434	3.074	2.102	1.374	0.807	0.354
Trim down (%)	1	2	3	4	5	6	7	8	9	10
V <sub>OUT</sub> (Volts)=	2.475	2.45	2.425	2.4	2.375	2.35	2.325	2.3	2.275	2.25
R <sub>D</sub> (K Ohms)=	49.641	22.481	13.428	8.902	6.186	4.375	3.082	2.112	1.358	0.754

PXF40-xxS3P3

Trim up (%)	1	2	3	4	5	6	7	8	9	10
V <sub>OUT</sub> (Volts)=	3.333	3.366	3.399	3.432	3.465	3.498	3.531	3.564	3.597	3.630
R <sub>U</sub> (K Ohms)=	57.930	26.165	15.577	10.283	7.106	4.988	3.476	2.341	1.459	0.753
Trim down (%)	1	2	3	4	5	6	7	8	9	10
V <sub>OUT</sub> (Volts)=	3.267	3.234	3.201	3.168	3.135	3.102	3.069	3.036	3.003	2.970
R <sub>D</sub> (K Ohms)=	69.470	31.235	18.490	12.117	8.294	5.745	3.924	2.559	1.497	0.647

## Output Voltage Adjustment(Continued)

## PXF40-xxS05

Trim up (%)	1	2	3	4	5	6	7	8	9	10
V <sub>OUT</sub> (Volts)=	5.050	5.100	5.150	5.200	5.250	5.300	5.350	5.400	5.450	5.500
R <sub>U</sub> (K Ohms)=	36.570	16.580	9.917	6.585	4.586	3.253	2.302	1.588	1.032	0.588
Trim down (%)	1	2	3	4	5	6	7	8	9	10
V <sub>OUT</sub> (Volts)=	4.950	4.900	4.850	4.800	4.750	4.700	4.650	4.600	4.550	4.500
R <sub>D</sub> (K Ohms)=	45.533	20.612	12.306	8.152	5.660	3.999	2.812	1.922	1.230	0.676

## PXF40-xxS12

Trim up (%)	1	2	3	4	5	6	7	8	9	10
V <sub>OUT</sub> (Volts)=	12.120	12.240	12.360	12.480	12.600	12.720	12.840	12.960	13.080	13.200
R <sub>U</sub> (K Ohms)=	367.910	165.950	98.636	64.977	44.782	31.318	21.701	14.488	8.879	4.391
Trim down (%)	1	2	3	4	5	6	7	8	9	10
V <sub>OUT</sub> (Volts)=	11.880	11.760	11.640	11.520	11.400	11.280	11.160	11.040	10.920	10.800
R <sub>D</sub> (K Ohms)=	460.990	207.950	123.600	81.423	56.118	39.249	27.199	18.162	11.132	5.509

## PXF40-xxS15

Trim up (%)	1	2	3	4	5	6	7	8	9	10
V <sub>OUT</sub> (Volts)=	15.150	15.300	15.450	15.600	15.750	15.900	16.050	16.200	16.350	16.500
R <sub>U</sub> (K Ohms)=	404.180	180.590	106.060	68.796	46.437	31.531	20.883	12.898	6.687	1.718
Trim down (%)	1	2	3	4	5	6	7	8	9	10
V <sub>OUT</sub> (Volts)=	14.850	14.700	14.550	14.400	14.250	14.100	13.950	13.800	13.650	13.500
R <sub>D</sub> (K Ohms)=	499.820	223.410	131.270	85.204	57.563	39.136	25.974	16.102	8.424	2.282

**Remote Sense Application Circuit**

The Remote Sense function can regulate the voltage at the terminals (local sensing) or at the load. (remote sensing). The maximum voltage compensation is 10%  $V_o$ , i.e.:

$$[V_o (+) \text{ to } V_o (-)] - [\text{Sense } (+) \text{ to } \text{Sense } (-)] < 10\% V_o$$

If the Remote Sense function is not used, then the SENSE (+) should be connected to OUTPUT (+) and the SENSE (-) should be connected to OUTPUT (-) of the PXF module.

RL1 and RL2 are conduction losses

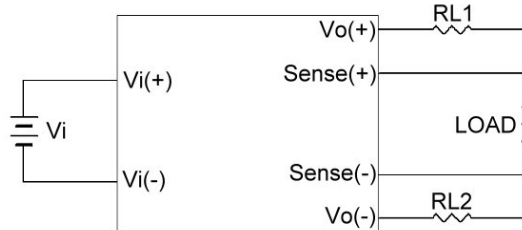

**Soldering and Reflow Consideration**

Lead free wave solder profile for PXF40 –xxSxx DIP type

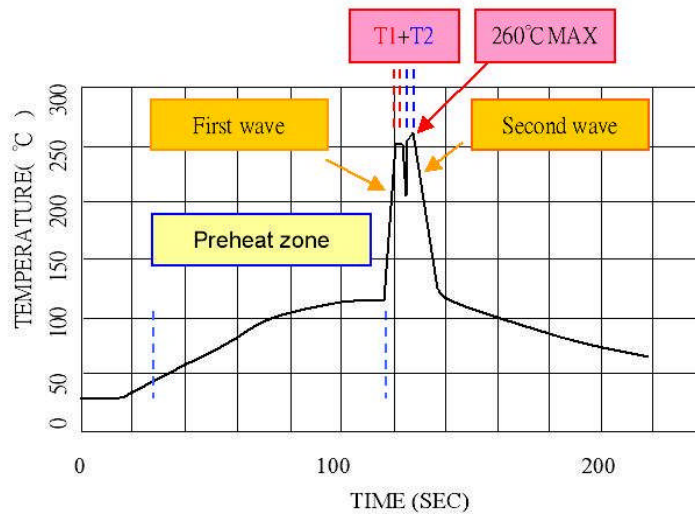

Zone	Reference Parameter
Preheat zone	Rise temp. speed : 3°C / sec max. Preheat temp. : 100~130°C
Actual heating	Peak temp. : 250~260°C Peak time (T1+T2 time) : 4~6 sec

**Reference Solder:** Sn-Ag-Cu / Sn-Cu

**Hand Welding:** Soldering iron-Power 90W

Welding Time: 2-4 sec

Temp.: 380-400 °C



Packaging Information

10 PCS per TUBE

**Part Number Structure**

**PXF 40 - 48 S 05**

**Max. Output Power**  
40Watts

**Input Voltage Range**  
12 : 9 ~ 18V  
24 : 18 ~ 36V  
48 : 36 ~ 75V

**Output Voltage**

1P5	: 1.5Vdc
1P8	: 1.8 Vdc
2P5	: 2.5 Vdc
3P3	: 3.3 Vdc
05	: 5Vdc
12	: 12Vdc
15	: 15Vdc

**Single Output**

Model Number	Input Range	Output Voltage	Output Current		Input Current		Eff <sup>(3)</sup> (%)
			Min. load	Full Load	No load <sup>(1)</sup>	Full Load <sup>(2)</sup>	
PXF40-12S1P5	9 – 18 VDC	1.5 VDC	0mA	8000mA	110mA	1250mA	84
PXF40-12S1P8	9 – 18 VDC	1.8 VDC	0mA	8000mA	110mA	1538mA	82
PXF40-12S2P5	9 – 18 VDC	2.5 VDC	0mA	8000mA	110mA	2083mA	84
PXF40-12S3P3	9 – 18 VDC	3.3 VDC	0mA	8000mA	175mA	2683mA	86
PXF40-12S05	9 – 18 VDC	5 VDC	0mA	8000mA	225mA	4065mA	86
PXF40-12S12	9 – 18 VDC	12 VDC	0mA	3333mA	255mA	4065mA	86
PXF40-12S15	9 – 18 VDC	15 VDC	0mA	2666mA	310mA	4015mA	87
PXF40-24S1P5	18 – 36 VDC	1.5 VDC	0mA	8000mA	40mA	649mA	81
PXF40-24S1P8	18 – 36 VDC	1.8 VDC	0mA	8000mA	40mA	759mA	83
PXF40-24S2P5	18 – 36 VDC	2.5 VDC	0mA	8000mA	40mA	1016mA	86
PXF40-24S3P3	18 – 36 VDC	3.3 VDC	0mA	8000mA	60mA	1325mA	87
PXF40-24S05	18 – 36 VDC	5 VDC	0mA	8000mA	80mA	1961mA	89
PXF40-24S12	18 – 36 VDC	12 VDC	0mA	3333mA	70mA	2048mA	88
PXF40-24S15	18 – 36 VDC	15 VDC	0mA	2666mA	85mA	1985mA	89
PXF40-48S1P5	36 – 75 VDC	1.5 VDC	0mA	8000mA	25mA	321mA	82
PXF40-48S1P8	36 – 75 VDC	1.8 VDC	0mA	8000mA	25mA	375mA	84
PXF40-48S2P5	36 – 75 VDC	2.5 VDC	0mA	8000mA	25mA	508mA	86
PXF40-48S3P3	36 – 75 VDC	3.3 VDC	0mA	8000mA	35mA	655mA	88
PXF40-48S05	36 – 75 VDC	5 VDC	0mA	8000mA	40mA	969mA	90
PXF40-48S12	36 – 75 VDC	12 VDC	0mA	3333mA	50mA	1000mA	89
PXF40-48S15	36 – 75 VDC	15 VDC	0mA	2666mA	50mA	992mA	89

Note 1. Typical value at nominal input voltage and no load.  
 Note 2. Maximum value at nominal input voltage and full load of standard type.  
 Note 3. Typical value at nominal input voltage and full load.

**Safety and Installation Instruction****Fusing Consideration**

Caution: This converter is not internally fused. An input line fuse must always be used.

This encapsulated converter can be used in a wide variety of applications, ranging from simple stand-alone operation to an integrated part of a sophisticated power architecture. For maximum flexibility, internal fusing is not included; however, to achieve maximum safety and system protection, always use an input line fuse. The safety agencies require a slow-blow fuse with maximum rating of 8A. Based on the information provided in this data sheet on Inrush energy and maximum DC input current; the same type of fuse with lower rating can be used. Refer to the fuse manufacturer's data for further information.

**MTBF and Reliability****The MTBF of PXF40-xxSxx DC/DC converters has been calculated using:**

Bellcore TR-NWT-000332 Case I: 50% stress, Operating Temperature at 40°C (Ground fixed and controlled environment ). The resulting figure for MTBF is  $1.398 \times 10^6$  hours.

MIL-HDBK-217F NOTICE2 FULL LOAD, Operating Temperature at 25°C °C. The resulting figure for MTBF is  $3.585 \times 10^5$  hours.