

Cable - VIP-CAB-FLK14/16/4,0M/S7 - 2904520

Please be informed that the data shown in this PDF Document is generated from our Online Catalog. Please find the complete data in the user's documentation. Our General Terms of Use for Downloads are valid (<http://phoenixcontact.com/download>)



Round cable set for SIMATIC® TOP connect with 1 x IDC/FLK socket strip (16-position) on 1 x IDC/FLK socket strip (14-position), Cable length: 4 m

RoHS

Key Commercial Data

Packing unit	1 STK
GTIN	
GTIN	4046356859332

Technical data

General

Nominal voltage U_N	< 50 V AC
	60 V DC
Max. current carrying capacity per path	1 A
Max. conductor resistance	0.16 Ω /m
Length of cable	4 m
Single wire, cross section	0.14 mm ²
Single wire, cross section [AWG]	26
Conductor construction: Number of litz wires:	7
Single wire, material	Cu tin-plated
External diameter	6.4 mm
Cable, preassembly	Insulation displacement, IEC 60352-4/DIN EN 60352-4
Shielding	no
Outer sheath, material	PVC
External sheath, color	gray RAL 7035

Environmental conditions

Ambient temperature (operation)	-20 °C ... 50 °C
Ambient temperature (storage/transport)	-20 °C ... 70 °C

Cable - VIP-CAB-FLK14/16/4,0M/S7 - 2904520

Technical data

Environmental conditions

Flame resistance	IEC 60332-1
	DIN VDE 0482 Part 332-1
Resistance to oil	UL 1581
Gasoline resistance	Against occasional splashes

Connector 1

Connection name	Field level
Connection method	IDC/FLK socket strip
Number of connections	1
Number of positions	14
Pitch	2.54 mm

Connector 2

Connection name	Controller level
Connection method	IDC/FLK socket strip
Number of connections	1
Number of positions	16
Pitch	2.54 mm

Supported controller

Controller	SIEMENS TOP connect
------------	---------------------

Standards and Regulations

Resistance to oil	UL 1581
Connection in acc. with standard	CUL
Flame resistance	IEC 60332-1
	DIN VDE 0482 Part 332-1

Environmental Product Compliance

China RoHS	Environmentally Friendly Use Period = 50
	For details about hazardous substances go to tab "Downloads", Category "Manufacturer's declaration"

Drawings

Cable - VIP-CAB-FLK14/16/4,0M/S7 - 2904520

Connection diagram

14-pos. Socket strip PIN	16-pos. Socket strip PIN	Wire color
1	16	Black
2	14	Brown
3	12	Red
4	10	Orange
5	8	Yellow
6	6	Green
7	4	Blue
8	2	Violet
9	9	Gray
10	1	White
11	11	White-black
12	3	White-brown
13	13	White-red
14	5	White-orange
	7	-
	15	-

Dimensional drawing

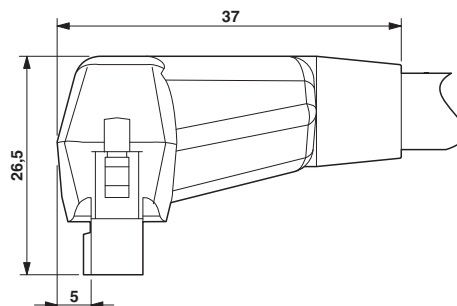

Pin assignment and color code

Approvals

Approvals

Approvals

EAC / UL Listed / cUL Listed / cULus Listed

Ex Approvals

Approval details

EAC		RU C- DE.A*30.B00767
-----	--	-------------------------

UL Listed		http://database.ul.com/cgi-bin/XYV/template/LISEXT/1FRAME/index.htm	FILE E 238705
Nominal current I _N		1 A	
Nominal voltage U _N		125 V	

cUL Listed		http://database.ul.com/cgi-bin/XYV/template/LISEXT/1FRAME/index.htm	FILE E 238705
Nominal current I _N		1 A	

Cable - VIP-CAB-FLK14/16/4,0M/S7 - 2904520

Approvals

Nominal voltage UN	125 V
--------------------	-------

cULus Listed



Phoenix Contact 2017 © - all rights reserved
<http://www.phoenixcontact.com>

PHOENIX CONTACT GmbH & Co. KG
Flachsmarktstr. 8
32825 Blomberg
Germany
Tel. +49 5235 300
Fax +49 5235 3 41200
<http://www.phoenixcontact.com>