

PACKAGE DIMENSIONS

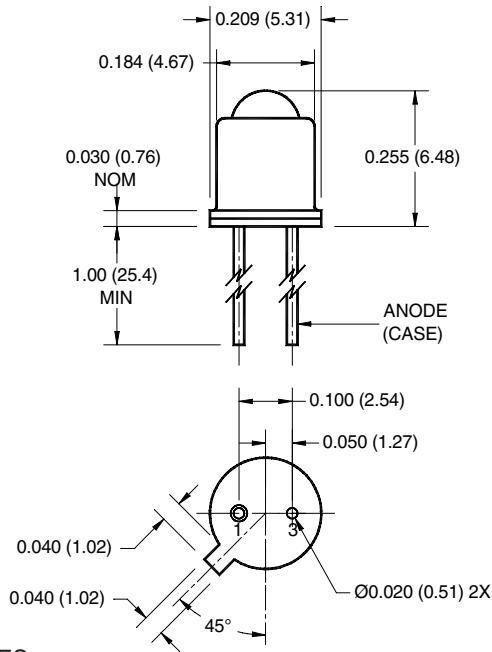

NOTES:

1. Dimensions for all drawings are in inches (mm).
2. Tolerance of $\pm .010$ (.25) on all non-nominal dimensions unless otherwise specified.

FEATURES

- Good optical to mechanical alignment
- Mechanically and wavelength matched to the TO-18 series phototransistor
- Hermetically sealed package
- High irradiance level
- (*) Indicates JEDEC registered values

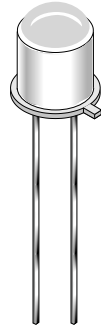

DESCRIPTION

- The 1N6266 is a 940 nm LED in a narrow angle, TO-46 package.

SCHEMATIC

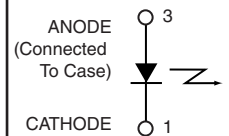

1. Derate power dissipation linearly 1.70 mW/°C above 25°C ambient.
2. Derate power dissipation linearly 13.0 mW/°C above 25°C case.
3. RMA flux is recommended.
4. Methanol or isopropyl alcohols are recommended as cleaning agents.
5. Soldering iron tip 1/16" (1.6mm) minimum from housing.
6. As long as leads are not under any stress or spring tension

ABSOLUTE MAXIMUM RATINGS (T_A = 25°C unless otherwise specified)

Parameter	Symbol	Rating	Unit
Operating Temperature	T _{OPR}	-65 to +125	°C
*Storage Temperature	T _{STG}	-65 to +150	°C
*Soldering Temperature (Iron) ^(3,4,5 and 6)	T _{SOL-I}	240 for 5 sec	°C
*Soldering Temperature (Flow) ^(3,4 and 6)	T _{SOL-F}	260 for 10 sec	°C
*Continuous Forward Current	I _F	100	mA
*Forward Current (pw, 1µs; 200Hz)	I _F	10	A
*Reverse Voltage	V _R	3	V
*Power Dissipation (T _A = 25°C) ⁽¹⁾	P _D	170	mW
Power Dissipation (T _C = 25°C) ⁽²⁾	P _D	1.3	W

ELECTRICAL / OPTICAL CHARACTERISTICS (T_A = 25°C) (All measurements made under pulse conditions)

PARAMETER	TEST CONDITIONS	SYMBOL	MIN	TYP	MAX	UNITS
*Peak Emission Wavelength	I _F = 100 mA	λ _P	935	—	955	nm
Emission Angle at 1/2 Power		θ	—	±10	—	Deg.
Forward Voltage	I _F = 100 mA	V _F	—	—	1.7	V
*Reverse Leakage Current	V _R = 3 V	I _R	—	—	10	µA
*Radiant Intensity	I _F = 100 mA	I _e	25	—	—	mW/sr
Rise Time 0-90% of output		t _r	—	1.0	—	µs
Fall Time 100-10% of output		t _f	—	1.0	—	µs

MAXIMUM RATINGS CURVES

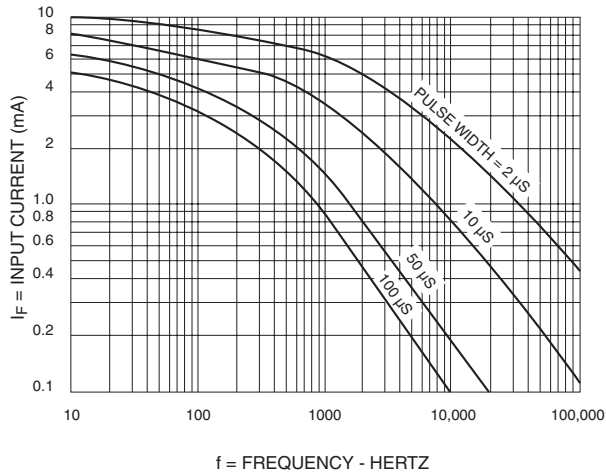

Fig.1 Maximum Pulse Capability

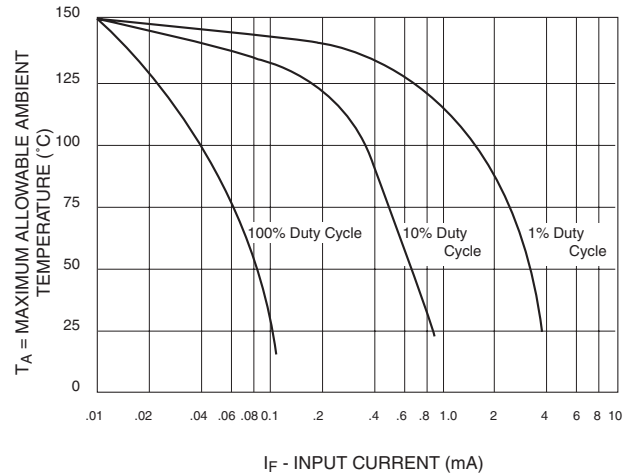

Fig.2 Maximum Temperature vs. Input Current

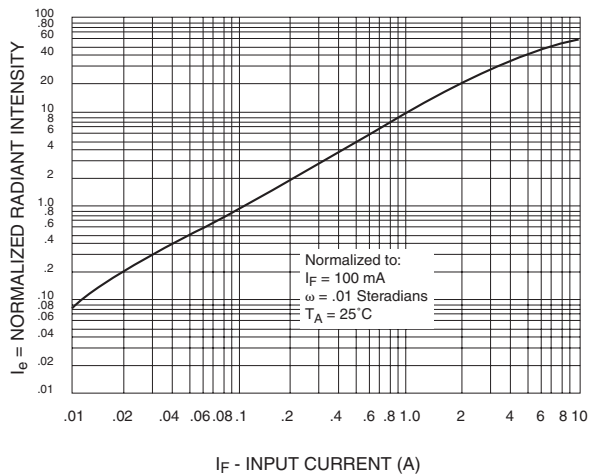

Fig.3 Radiant Intensity vs. Input Current $\Delta I_e/\Delta I$

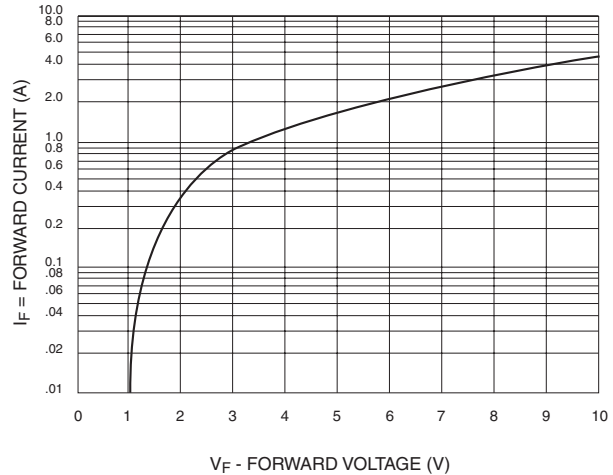

Fig.4 Forward Voltage vs. Forward Current

MAXIMUM RATINGS CURVES

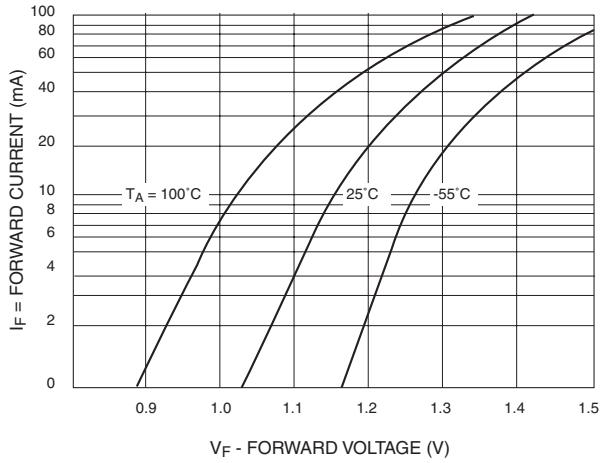

Fig.5 Forward Voltage vs. Forward Current

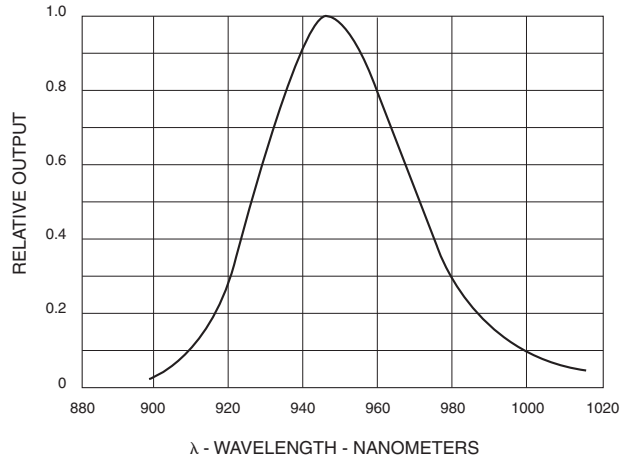

Fig.6 Spectral Output

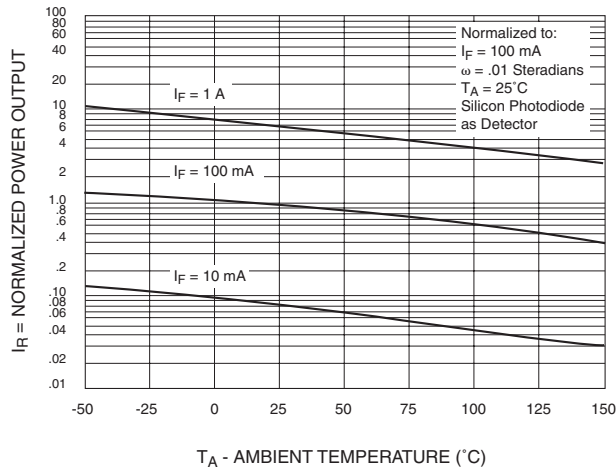

Fig.7 Output vs. Temperature

INFRARED EMITTING DIODE RADIANT INTENSITY

The design of an Infrared Emitting Diode (IRED)-photodetector system normally requires the designer to determine the minimum amount of infrared irradiance received by the photodetector, which then allows definition of the photodetector current. Prior to the introduction of the 1N6266, the best method of estimating the photodetector received infrared was to geometrically proportion the piecewise integration of the typical beam pattern with the specified minimum total power output of the IRED. However, due to inconsistencies of the IRED integral lenses and the beam lobes, this procedure will not provide a valid estimation.

The 1N6266 now provides the designer specifications which precisely define the infrared beam along the device's mechanical axis. The 1N6266 is a premium device selected to give a minimum radiant intensity of 25 mW/steradian into the 0.01 steradians referenced by the the device's mechanical axis and seating plane. Radiant intensity is the IRED beam power output, within a specified solid angle, per unit solid angle.

A quick review of geometry indicates that a steradian is a unit of solid angle, referenced to the center of a sphere, defined by 4 π times the ratio of the area projected by the solid angle to the area of the sphere. The solid angle is equal to the projected area divided by the squared radius.

$$\text{Steradians} = 4 \pi A / 4 \pi R^2 = A/R^2 = \omega$$

As the projected area has a circular periphery, a geometric integration will solve to show the relationship of the Cartesian angle (α) of the cone, (from the center of the sphere) to the projected area.

$$\omega = 2 \pi (1 - \cos \frac{\alpha}{2})$$

Radiant intensity provides an easy, accurate tool to calculate the infrared power received by a photodetector located on the IRED axis. As the devices are selected for beam characteristics, the calculated results are valid for worst case analysis. For many applications a simple approximation for photodetector irradiance is:

$$H \cong I_e/d^2, \text{ in mw/cm}^2$$

where d is the distance from the IRED to the detector in cm.

IRED power output, and therefore I_e , depends on IRED current. This variation ($\Delta I_e/\Delta I$) is documented in Figure 3, and completes the approximation: $H = I_e/d^2 (\Delta I_e/\Delta I)$. This normally gives a conservative value of irradiance. For more accurate results, the effect of precise angle viewed by the detector must be considered. This is documented in figure 8 ($\Delta I_e/\Delta \omega$) giving:

$$H = I_e/d^2 (\Delta I_e/\Delta \omega) \text{ in mw/cm}^2$$

For worst case designs, temperature coefficients and tolerances must be considered.

The minimum output current of the detector (I_L) can be determined for a given distance (d) of the detector from the IRED.

$$I_L = (S)H \cong (S) I_e/d^2$$

or

$$I_L = (S)H = (S) (I_e/d^2) (\Delta I_e/\Delta \omega) (\Delta I_e/\Delta I)$$

where S is the sensitivity of the detector in terms of output current per unit irradiance from a GaAs source.

IRED RADIANT INTENSITY SPECIFICATION CONCEPT

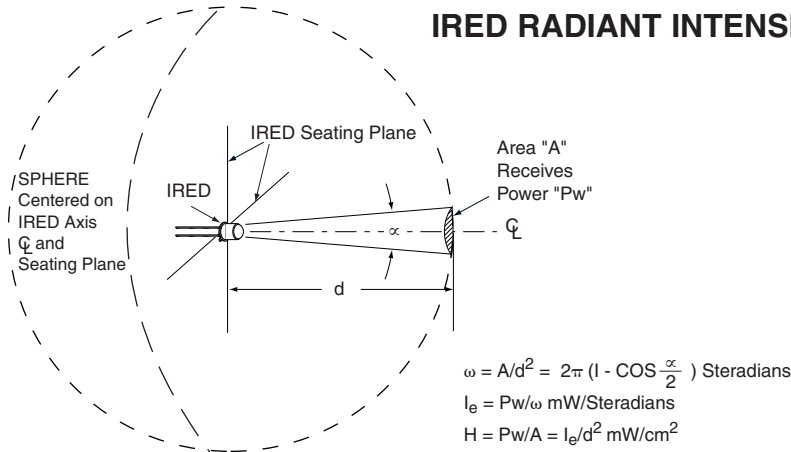

MATCHING A PHOTOTRANSISTOR WITH 1N6266

Assume a system requiring a 10 mA I_L at an IRED to detector spacing of 2 cm (seating plane to seating plane), with bias conditions at specification points.

Given: $d_1 = 2$ cm, $I_L = 10$ mA min.; $I_e = 25$ mW/Steradian

Then: $H_1 \cong I_e/d_1^2 = 25/(2)^2 = 6.25$ mW/cm²

Detector Evaluation:

TYPE	I_L MIN mA	@	H (GaAs) mW/cm ²	\cong	S(GaAs) mA/mw/cm ²
L14G1	1		0.5		2
L14G2	0.5		0.5		1

Calculated I_L @ d_1 is:

L14G1 (S) $H_1 = (2) 6.25 = 12.5$ mA

L14G2 (S) $H_1 = (1) 6.25 = 6.25$ mA

Since the system requires an I_L of 10 mA minimum the correct device to use is the L14G1.

TYPICAL CHARACTERISTICS

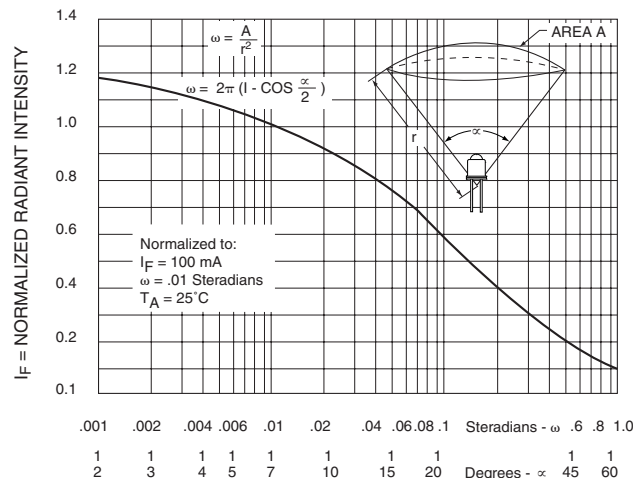
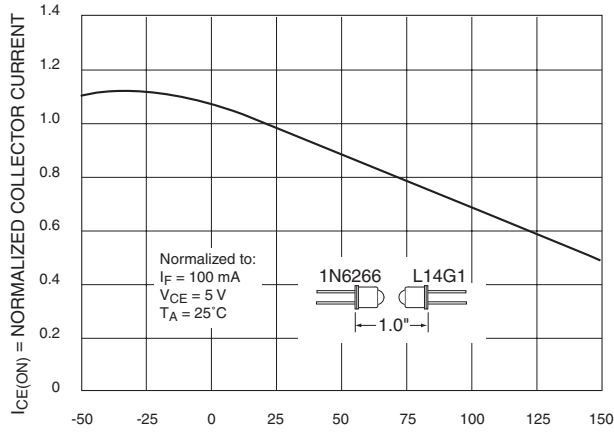

Fig.8 Intensity and Power vs. Angle $\Delta I_e/\Delta \omega$

MAXIMUM RATINGS CURVES



T_A - AMBIENT TEMPERATURE (C)

Fig. 9 Output vs. Ambient Temperature IRED/Phototransistor Pair

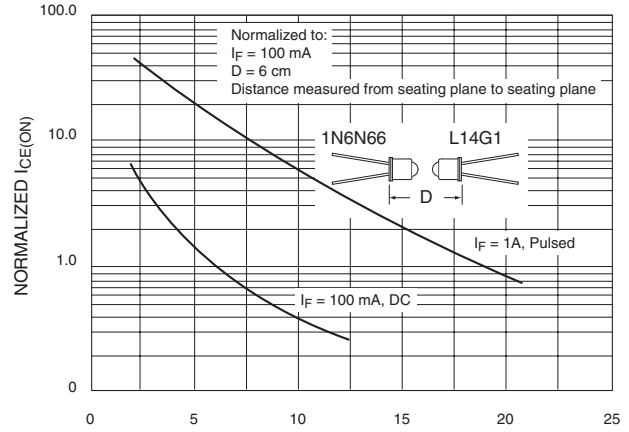

D - cm

Fig. 10 I_L vs. Distance IRED/Phototransistor Pair

DISCLAIMER

FAIRCHILD SEMICONDUCTOR RESERVES THE RIGHT TO MAKE CHANGES WITHOUT FURTHER NOTICE TO ANY PRODUCTS HEREIN TO IMPROVE RELIABILITY, FUNCTION OR DESIGN. FAIRCHILD DOES NOT ASSUME ANY LIABILITY ARISING OUT OF THE APPLICATION OR USE OF ANY PRODUCT OR CIRCUIT DESCRIBED HEREIN; NEITHER DOES IT CONVEY ANY LICENSE UNDER ITS PATENT RIGHTS, NOR THE RIGHTS OF OTHERS.

LIFE SUPPORT POLICY

FAIRCHILD'S PRODUCTS ARE NOT AUTHORIZED FOR USE AS CRITICAL COMPONENTS IN LIFE SUPPORT DEVICES OR SYSTEMS WITHOUT THE EXPRESS WRITTEN APPROVAL OF THE PRESIDENT OF FAIRCHILD SEMICONDUCTOR CORPORATION. As used herein:

1. Life support devices or systems are devices or systems which, (a) are intended for surgical implant into the body, or (b) support or sustain life, and (c) whose failure to perform when properly used in accordance with instructions for use provided in labeling, can be reasonably expected to result in a significant injury of the user.
2. A critical component in any component of a life support device or system whose failure to perform can be reasonably expected to cause the failure of the life support device or system, or to affect its safety or effectiveness.