

High Frequency Ceramic Solutions

5.4GHz EIA 0603 Mini Balun with DC Feed Option. 100Ω Differential

P/N 5400BL14B100

Impedance, 50Ω Single Ended

Detail Specification: 9/18/2014

Page 1 of 4

General Specifications

Part Number	5400BL14B100	Phase Difference	180±10 deg
Frequency (MHz)	4900 - 5875	Return Loss	9.5 dB min.
Balanced Diff. Impedance	100 Ω	Operating Temperature	-40 to +85°C
Unbalanced Impedance	50 Ω	Reel Quantity	4,000 pcs
Insertion Loss @ BW	0.8dB Typ (1.0 dB max.)	Power Capacity	0.5W max. (CW)

You can download measured s-parameters of this component at: <http://www.johansontechnology.com/rfbaluns>

Part Number Explanation

P/N Suffix	Packaging Style	Bulk	Suffix = S	Eg. 5400BL14B100S
		T & R	Suffix = T	Eg. 5400BL14B100T (Reel: 4000pcs.)
	Termination Style	100% Tin	Suffix = None	Eg. 5400BL14B100(T or S)

Mechanical Dimensions

	In	mm
L	0.063 ± 0.004	1.60 ± 0.10
W	0.031 ± 0.004	0.80 ± 0.10
T	0.024 ± 0.004	0.60 ± 0.10
a	0.008 ± 0.004	0.20 ± 0.10
b	0.008 +0.004/0.006	0.20 +0.1/-0.15
c	0.006 ± 0.004	0.15 ± 0.10
g	0.012 ± 0.004	0.30 ± 0.10
p	0.020 ± 0.002	0.50 ± 0.05

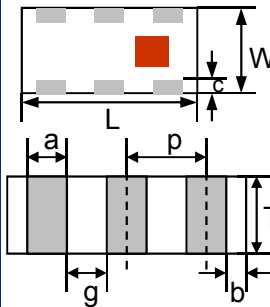

Terminal Configuration

1	Unbalanced Port	4	Balanced Port (OUT2)
2	DC feed + RD GND	5	GND
3	Balanced Port (OUT1)	6	NC

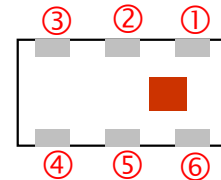

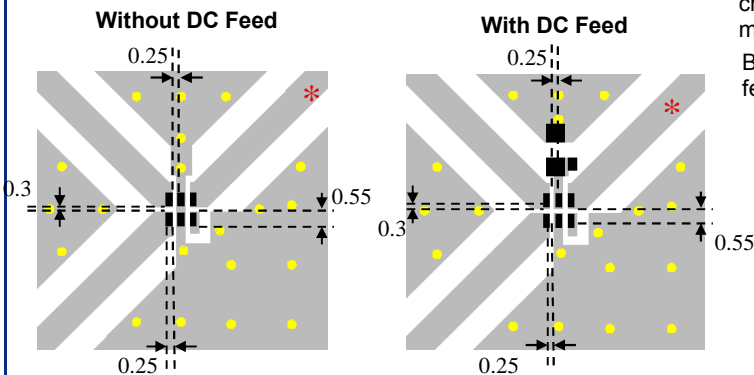

Mounting Considerations

Mount these devices with brown mark facing up.



* Line width should be designed to match 50 Ω characteristic impedance, depending on PCB material and thickness.

By-pass capacitor should be connected when feeding DC power, go to page 2 for details

-  Solder Resist
-  Land
-  Through-hole (Ø0.3)

Units: mm

Need our help laying this out for you? Need the layout file? Send us a message at: www.johansontechnology.com/component/techquestion

Johanson Technology, Inc. reserves the right to make design changes without notice.

All sales are subject to Johanson Technology, Inc. terms and conditions.



www.johansontechnology.com

4001 Calle Tecate • Camarillo, CA 93012, USA • TEL +1.805.389.1166

Ver 1.1

2014 Johanson Technology, Inc. All Rights Reserved

High Frequency Ceramic Solutions

5.4GHz EIA 0603 Mini Balun with DC Feed Option. 100Ω Differential Impedance, 50Ω Single Ended

P/N 5400BL14B100

Detail Specification: 9/18/2014

Page 2 of 4

Equivalent Circuit

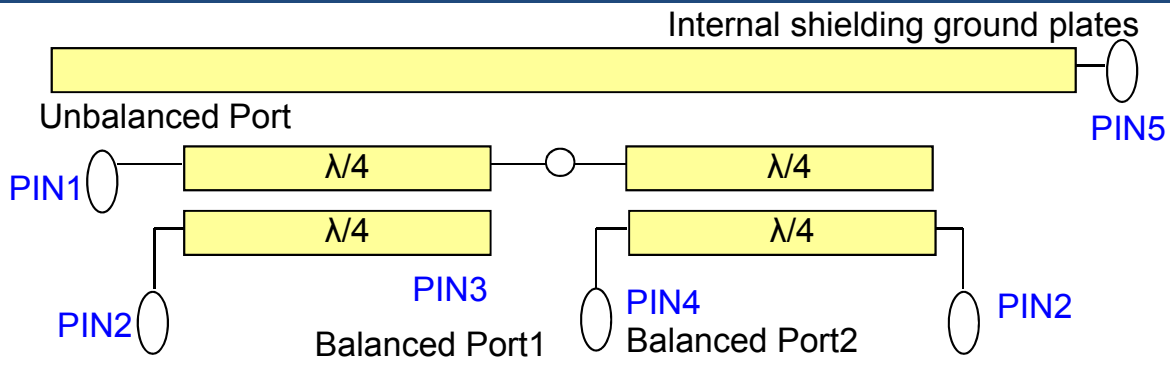

Pin 6 is a floating pin (no internal connections) but it still must have soldering pad

Measuring Diagram

DC-Feed recommended L/C network:

Capacitor value of 2.7pF and RF choke (inductor) 3.9nH are recommended when DC bias is used.

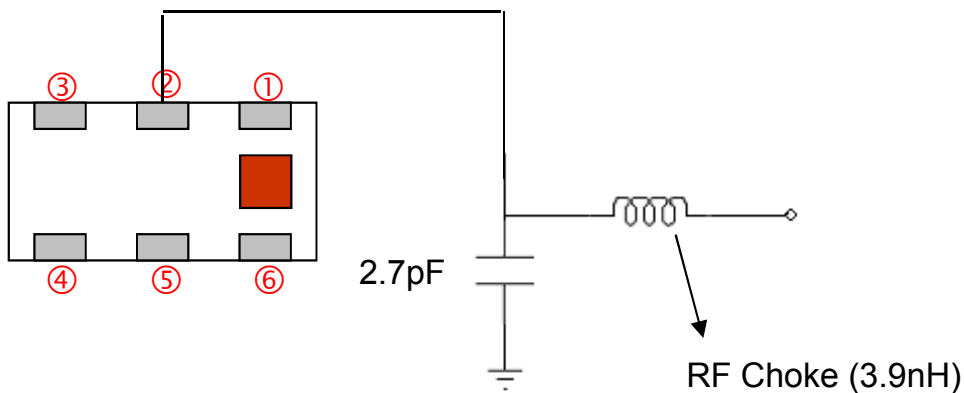

Bypass capacitor and RF choke should be placed physically as close as possible to PIN2 of balun.

Johanson Technology, Inc. reserves the right to make design changes without notice.

All sales are subject to Johanson Technology, Inc. terms and conditions.



www.johansontech.com

4001 Calle Tecate • Camarillo, CA 93012, USA • TEL +1.805.389.1166

Ver 1.1

2014 Johanson Technology, Inc. All Rights Reserved

High Frequency Ceramic Solutions

5.4GHz EIA 0603 Mini Balun with DC Feed Option. 100Ω Differential Impedance, 50Ω Single Ended

P/N 5400BL14B100

Detail Specification: 9/18/2014

Page 3 of 4

Typical Electrical Characteristics (T=25°C)

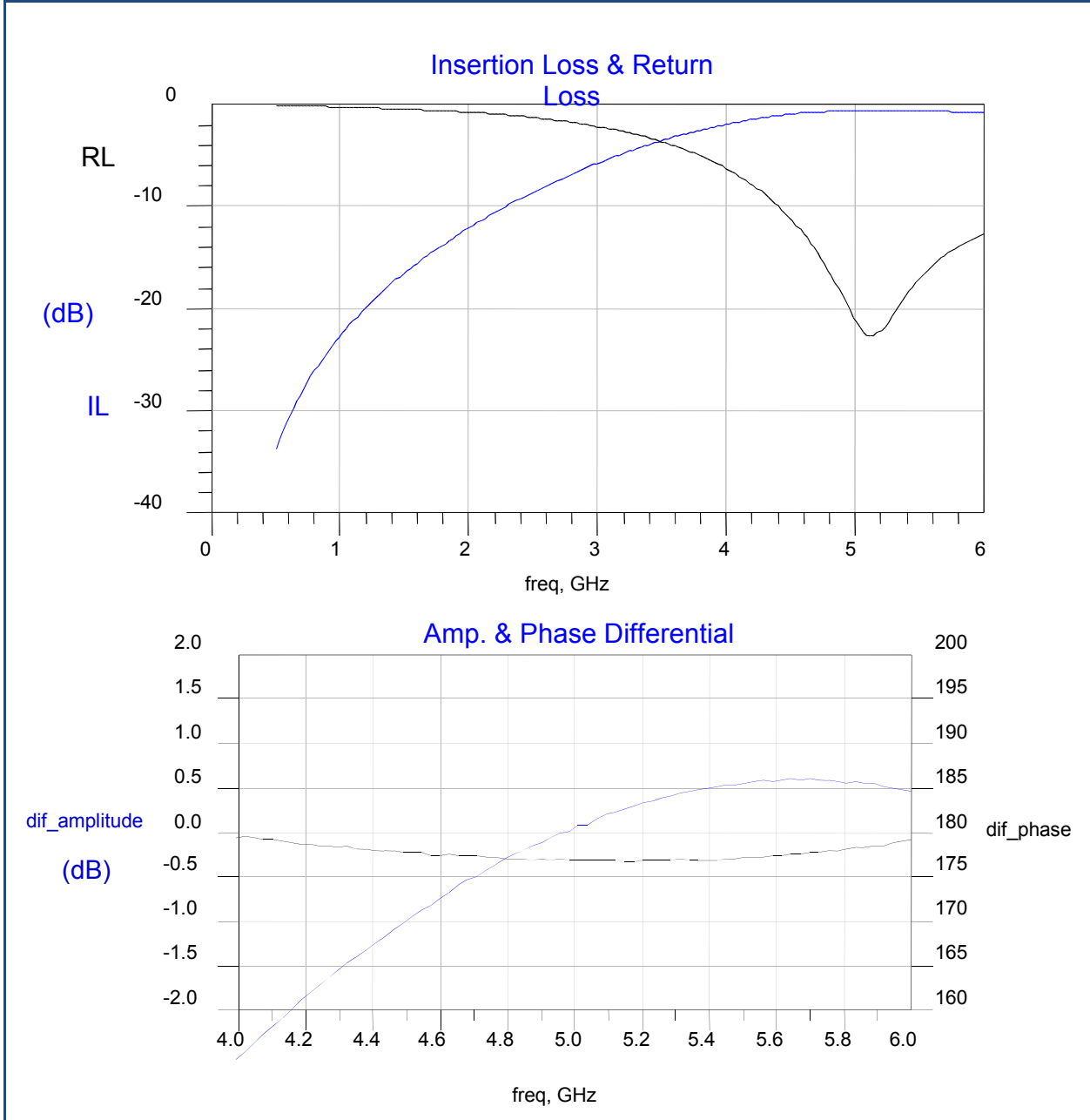

Johanson Technology, Inc. reserves the right to make design changes without notice.

All sales are subject to Johanson Technology, Inc. terms and conditions.



www.johansontechology.com

4001 Calle Tecate • Camarillo, CA 93012, USA • TEL +1.805.389.1166

Ver 1.1 2014 Johanson Technology, Inc. All Rights Reserved

High Frequency Ceramic Solutions

5.4GHz EIA 0603 Mini Balun with DC Feed Option. 100Ω Differential Impedance, 50Ω Single Ended

P/N 5400BL14B100

Detail Specification: 9/18/2014

Page 4 of 4

More Balun info at:

<http://www.johansontechnology.com/rfbaluns>

Packaging Information

www.johansontechnology.com/ipcpackaging.html

Soldering Information

www.johansontechnology.com/ipcsoldering-profile

MSL Info

www.johansontechnology.com/technical-notes/msl-rating.html

Recommended Storage Condition and Max Shelf Life

www.johansontechnology.com/ipcstorage-shelflife

RoHS Compliance

www.johansontechnology.com/technical-notes/rohs-compliance.html

Antenna layout and tuning techniques

www.johansontechnology.com/tuning

Antenna layout review, tuning, and characterization services

www.johansontechnology.com/ipcantennaservices

Johanson Technology, Inc. reserves the right to make design changes without notice.

All sales are subject to Johanson Technology, Inc. terms and conditions.



www.johansontechnology.com

4001 Calle Tecate • Camarillo, CA 93012, USA • TEL +1.805.389.1166

Ver 1.1

2014 Johanson Technology, Inc. All Rights Reserved