

## RONDA-WWW-C

~90° wide beam with holder C compatible with LEDiL HEKLA

### TECHNICAL SPECIFICATIONS:

Dimensions	Ø 53.9 mm
Height	17 mm
Fastening	socket
Colour	clear
Box size	
Box weight	0 kg
Quantity in Box	420 pcs
ROHS compliant	yes ⓘ



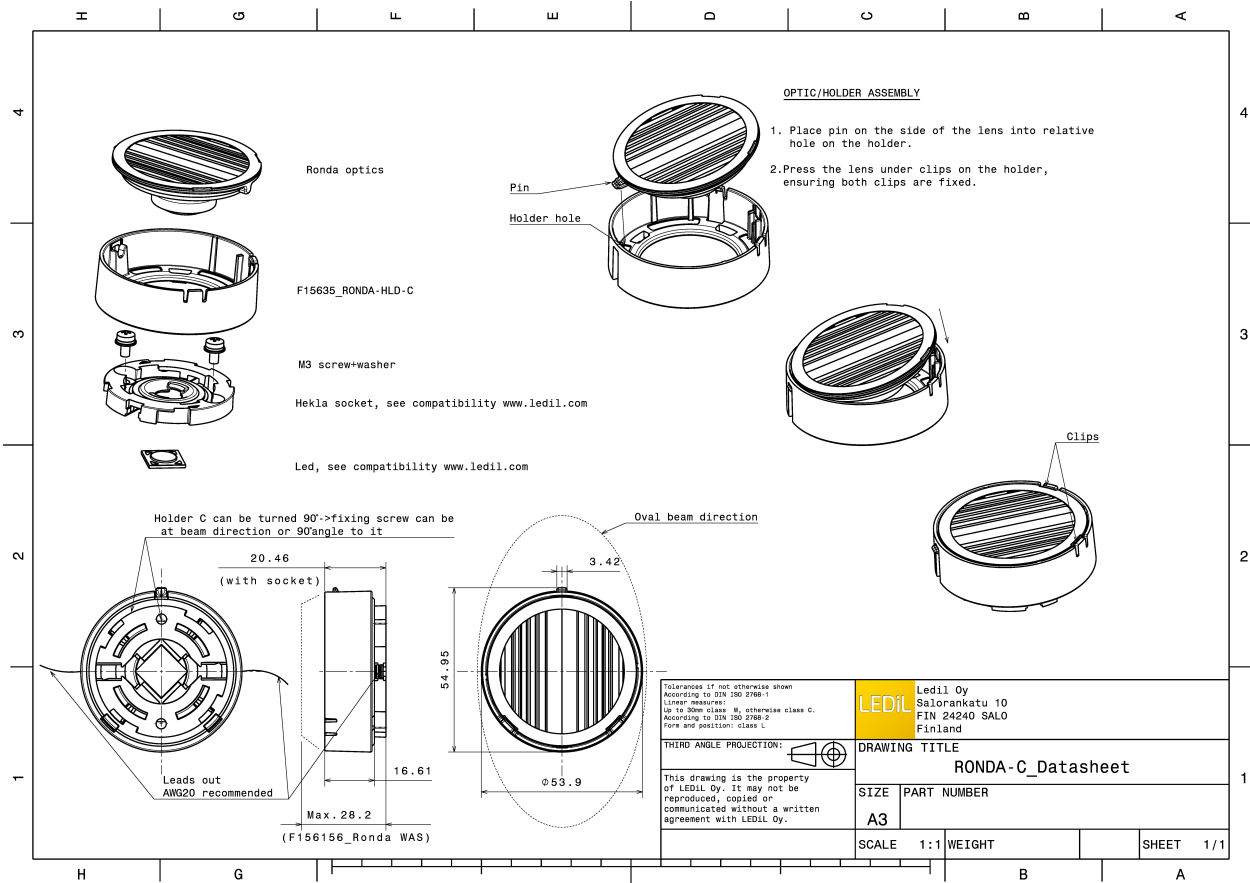

### MATERIAL SPECIFICATIONS:

Component	Type	Material	Colour
RONDA-WWW	Lens	PMMA	clear
RONDA-HLD-C	Holder	PC	clear

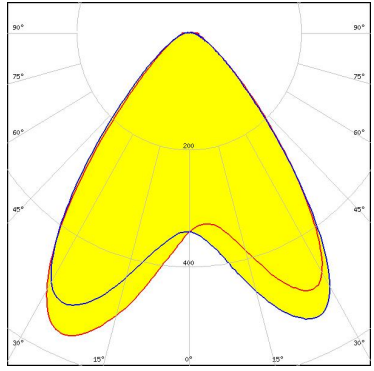
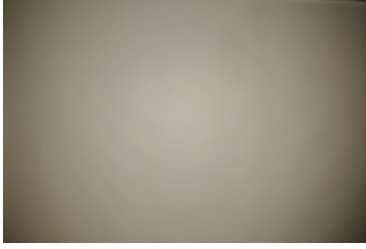
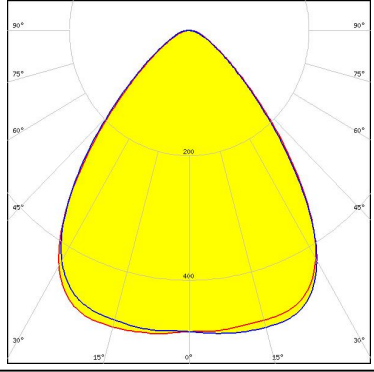

**PHOTOMETRIC DATA (MEASURED):**

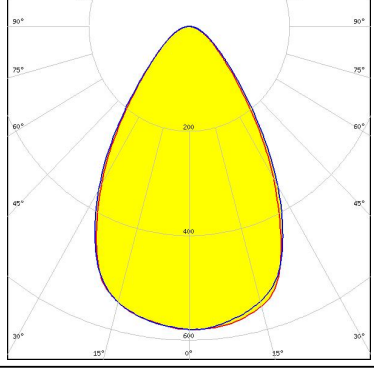
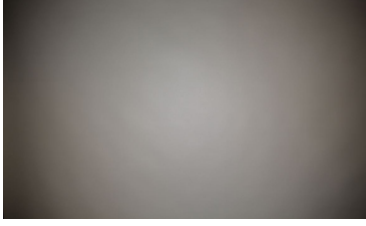
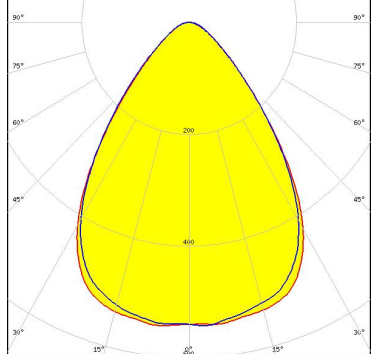
<p>bridgelux.</p> <p>LED V6 Gen6            FWHM 89.0°            Efficiency 90 %            Peak intensity 0.560 cd/lm            Required components:            F15253_HEKLA-SOCKET-A</p>		
<p>bridgelux.</p> <p>LED VERO10            FWHM 82.0°            Efficiency 89 %            Peak intensity 0.490 cd/lm            Required components:            F15616_HEKLA-SOCKET-F</p>		
<p>bridgelux.</p> <p>LED Vesta DTW 15mm (33W)            FWHM 67.0°            Efficiency 78 %            Peak intensity 0.580 cd/lm            Required components:            C16142_HEKLA-SOCKET-K            Bender Wirth: 491 Typ L8</p>		
<p>bridgelux.</p> <p>LED Vesta TW 9mm (12W)            FWHM 75.0°            Efficiency 86 %            Peak intensity 0.550 cd/lm            Required components:            C16142_HEKLA-SOCKET-K</p>		

### PHOTOMETRIC DATA (MEASURED):

#### CITIZEN

LED CLC020 Series (Dim-To-Warm)  
FWHM 73.0°  
Efficiency 86 %  
Peak intensity 0.590 cd/lm  
Required components:  
C16142\_HEKLA-SOCKET-K

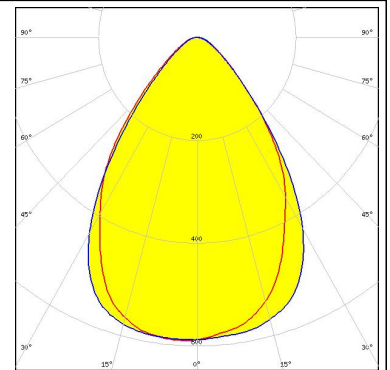
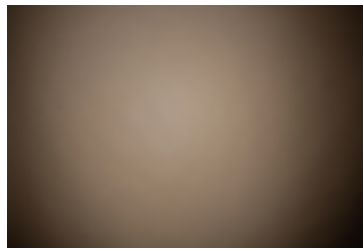

#### CITIZEN

LED CLL02x/CLU02x (LES10)  
FWHM 81.0°  
Efficiency 89 %  
Peak intensity 0.500 cd/lm  
Required components:  
F15255\_HEKLA-SOCKET-C

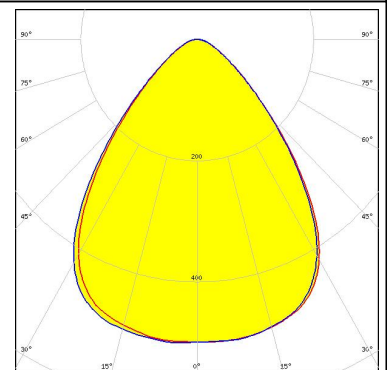
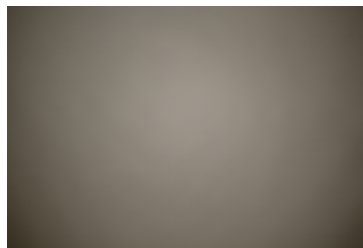

#### CITIZEN

LED CLU700/701  
FWHM 93.0°  
Efficiency 89 %  
Peak intensity 0.520 cd/lm  
Required components:  
F15255\_HEKLA-SOCKET-C

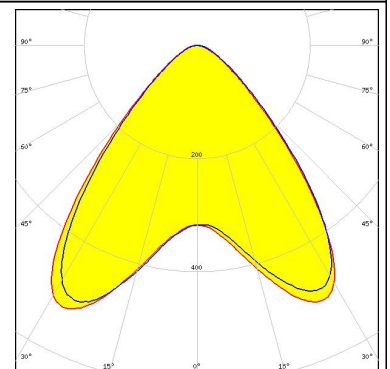
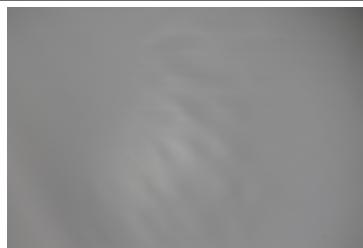

#### CITIZEN

LED LCN-C01B (Tunable White)  
FWHM 74.0°  
Efficiency 86 %  
Peak intensity 0.570 cd/lm  
Required components:  
C16142\_HEKLA-SOCKET-K

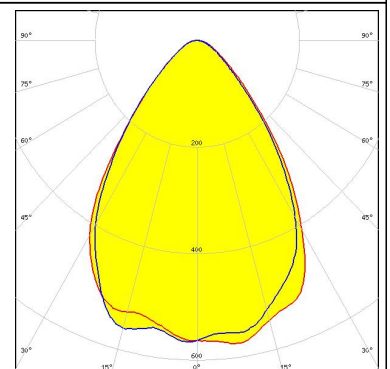
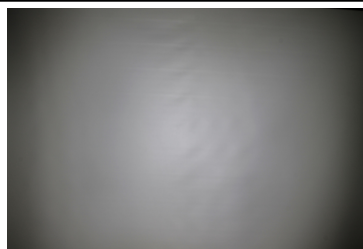



**PHOTOMETRIC DATA (MEASURED):**



LED CMA1516  
 FWHM 83.0°  
 Efficiency 89 %  
 Peak intensity 0.480 cd/lm  
 Required components:  
 F15256\_HEKLA-SOCKET-D

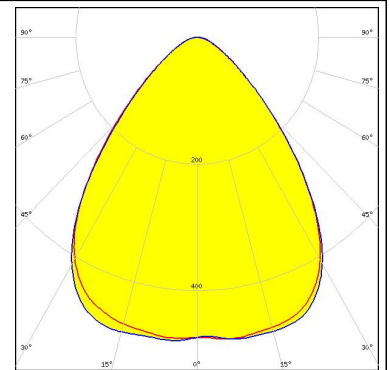

LED CMA1825  
 FWHM 77.0°  
 Efficiency 87 %  
 Peak intensity 0.530 cd/lm  
 Required components:  
 F15254\_HEKLA-SOCKET-B

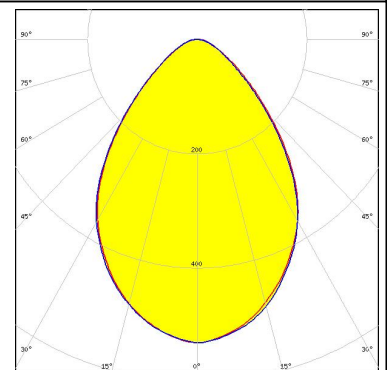
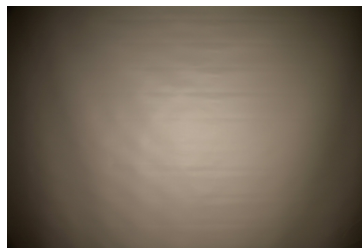

LED CXA/B 13xx  
 FWHM 94.0°  
 Efficiency 90 %  
 Peak intensity 0.500 cd/lm  
 Required components:  
 F15254\_HEKLA-SOCKET-B  
 LEDiL: F15956\_HEKLA-SOCKET-J

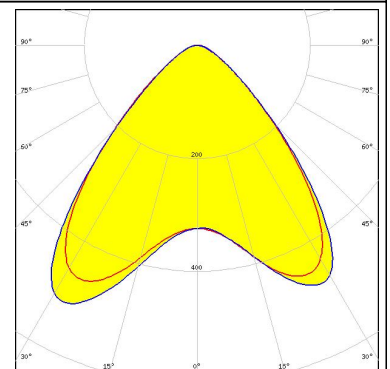

LED CXA/B 15xx  
 FWHM 84.0°  
 Efficiency 90 %  
 Peak intensity 0.500 cd/lm  
 Required components:  
 F15256\_HEKLA-SOCKET-D

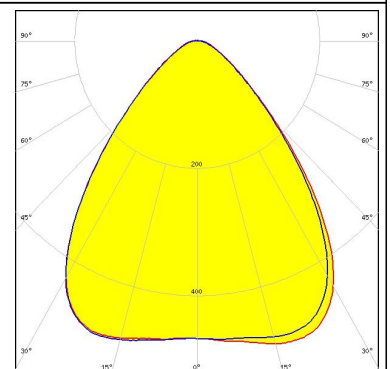
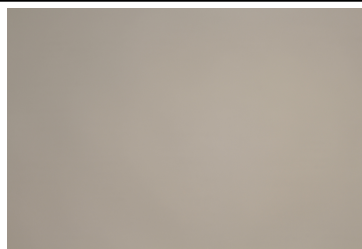

**PHOTOMETRIC DATA (MEASURED):**

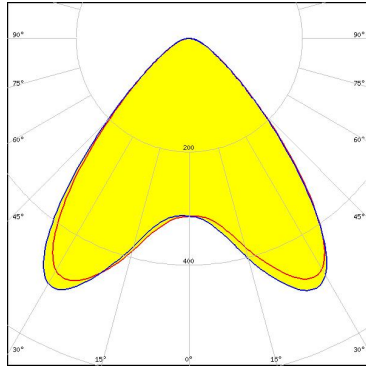
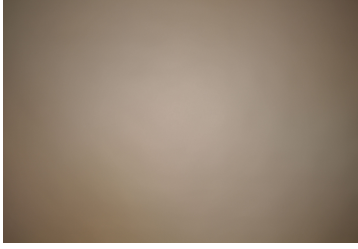
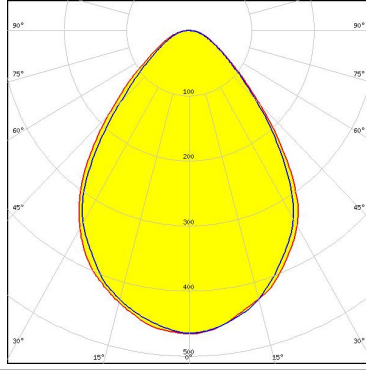
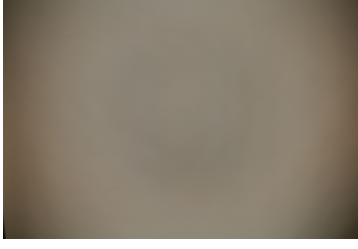
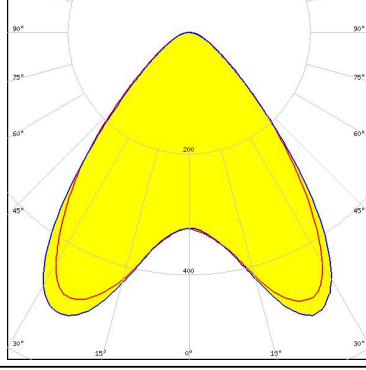
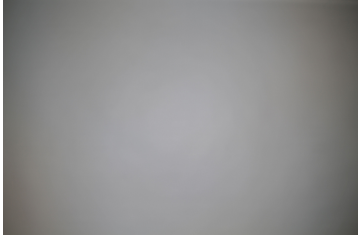
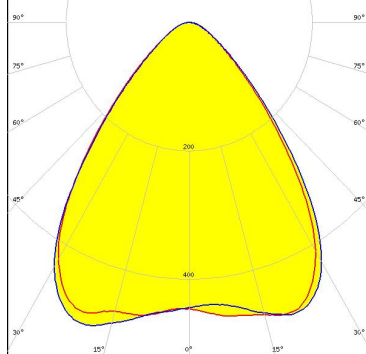
<p><b>LUMILEDS</b></p> <p>LED LUXEON CoB 1202s            FWHM 94.0°            Efficiency 90 %            Peak intensity 0.500 cd/lm            Required components:            F15848_HEKLA-SOCKET-G</p>		
<p><b>LUMINUS</b></p> <p>LED CDM-14 (Dim-To-Warm)            FWHM 81.0°            Efficiency 80 %            Peak intensity 0.500 cd/lm            Required components:            C16142_HEKLA-SOCKET-K            Bender Wirth: 491 Typ L8</p>		
<p><b>LUMINUS</b></p> <p>LED CDM-6 (Dim-To-Warm)            FWHM 90.0°            Efficiency 87 %            Peak intensity 0.510 cd/lm            Required components:            C16142_HEKLA-SOCKET-K            Bender Wirth: 490 Typ L8</p>		
<p><b>LUMINUS</b></p> <p>LED CDM-9 (Dim-To-Warm)            FWHM 82.0°            Efficiency 86 %            Peak intensity 0.500 cd/lm            Required components:            C16142_HEKLA-SOCKET-K            Bender Wirth: 490 Typ L8</p>		

**PHOTOMETRIC DATA (MEASURED):**

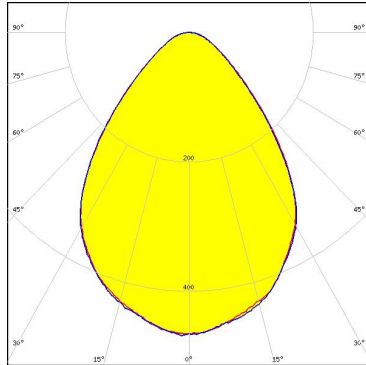
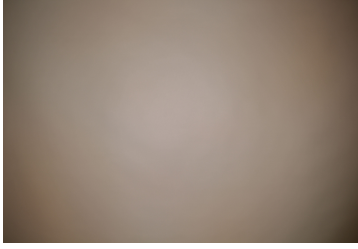
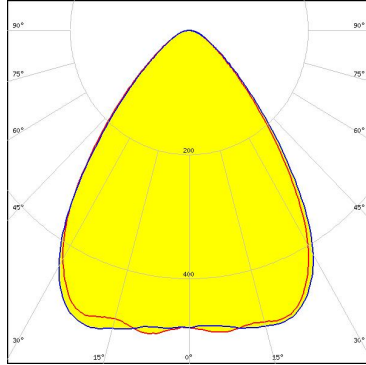
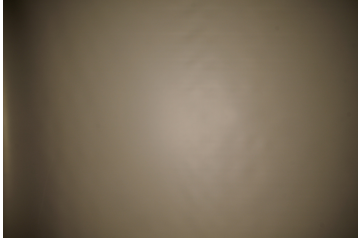
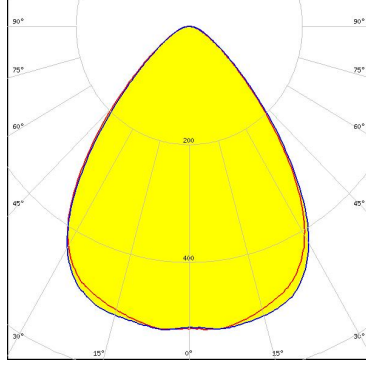
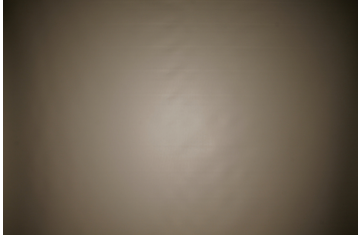
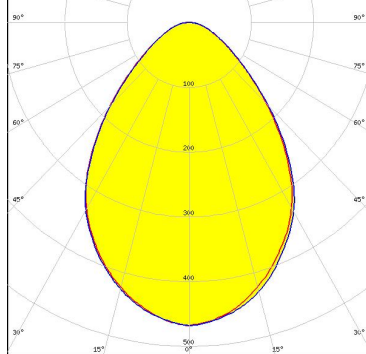
<p><b>LUMINUS</b></p> <p>LED CTM-14 (Tunable White)            FWHM 79.0°            Efficiency 81 %            Peak intensity 0.470 cd/lm            Required components:            C16142_HEKLA-SOCKET-K            Bender Wirth: 442 Typ L8</p>		
<p><b>LUMINUS</b></p> <p>LED CTM-9 (Tunable White)            FWHM 79.0°            Efficiency 86 %            Peak intensity 0.500 cd/lm            Required components:</p>		
<p><b>LUMINUS</b></p> <p>LED CXM-9            FWHM 80.0°            Efficiency 89 %            Peak intensity 0.520 cd/lm            Required components:            F15255_HEKLA-SOCKET-C</p>		
<p><b>SAMSUNG</b></p> <p>LED COB D Series LES 14.5 mm            FWHM 80.0°            Efficiency 82 %            Peak intensity 0.470 cd/lm            Required components:            F15859_HEKLA-SOCKET-I</p>		

**PHOTOMETRIC DATA (MEASURED):**

**SAMSUNG**

LED COB D Series LES 9.8 mm  
 FWHM 81.0°  
 Efficiency 90 %  
 Peak intensity 0.510 cd/lm  
 Required components:  
 F15255\_HEKLA-SOCKET-C

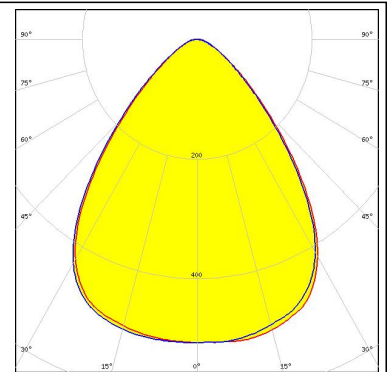
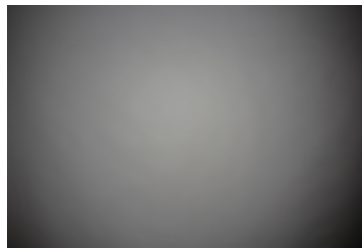

**SAMSUNG**

LED LC010C  
 FWHM 94.0°  
 Efficiency 89 %  
 Peak intensity 0.480 cd/lm  
 Required components:  
 F15848\_HEKLA-SOCKET-G

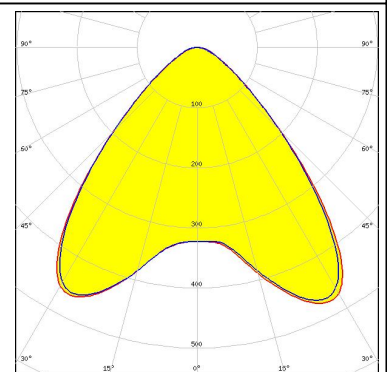
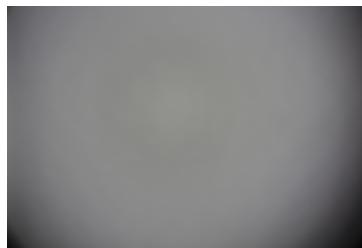

**SAMSUNG**

LED LC010C G2  
 FWHM 94.0°  
 Efficiency 89 %  
 Peak intensity 0.520 cd/lm  
 Required components:  
 F15255\_HEKLA-SOCKET-C

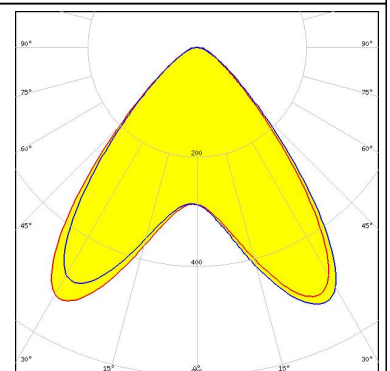

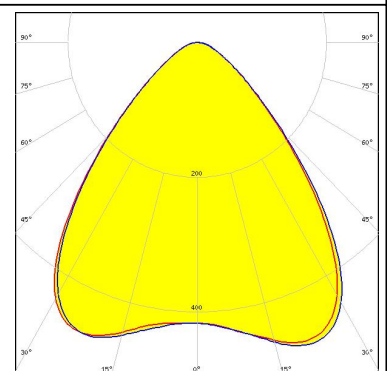
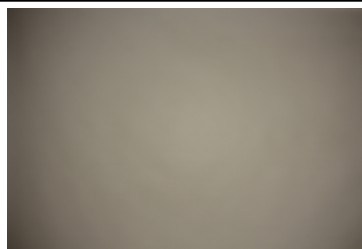

**SAMSUNG**

LED LC020C  
 FWHM 87.0°  
 Efficiency 90 %  
 Peak intensity 0.480 cd/lm  
 Required components:  
 F15848\_HEKLA-SOCKET-G



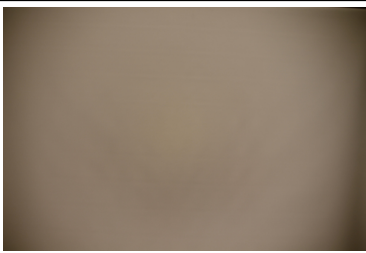
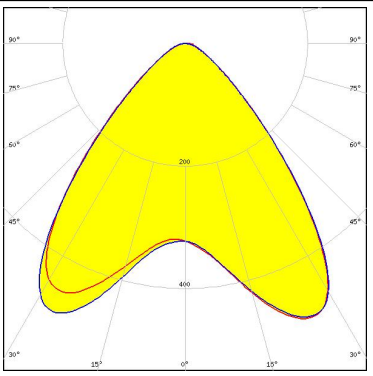

### PHOTOMETRIC DATA (MEASURED):

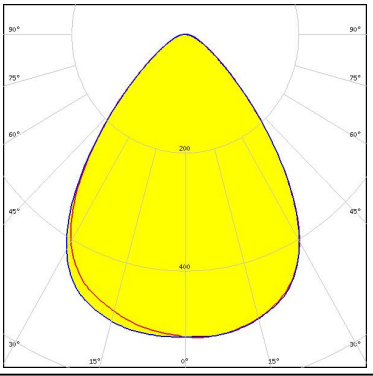
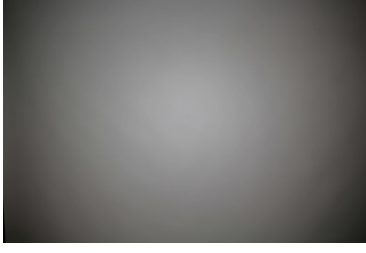
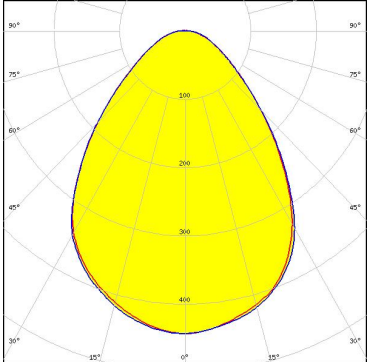
<p> SEOUL SEMICONDUCTOR</p> <p>LED MJT COB LES 6 FWHM 91.0° Efficiency 86 % Peak intensity 0.510 cd/lm Required components: F15255_HEKLA-SOCKET-C</p>		
<p> SEOUL SEMICONDUCTOR</p> <p>LED MJT COB LES 9.8 FWHM 79.0° Efficiency 86 % Peak intensity 0.510 cd/lm Required components: F15255_HEKLA-SOCKET-C</p>		
<p><b>XICATO</b></p> <p>LED XTM - 19mm LES FWHM 81.0° Efficiency 83 % Peak intensity 0.440 cd/lm Required components: C16058_XTM-ADAPTER-50-C</p>		



## PHOTOMETRIC DATA (SIMULATED):

### TRIDONIC

LED SLE G6 LES10

FWHM 85.0°

Efficiency 93 %

Peak intensity 0.487 cd/lm

Required components:

F15255\_HEKLA-SOCKET-C

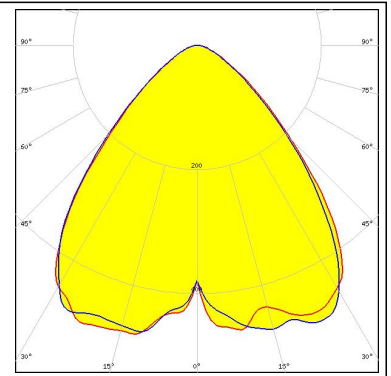

#### GENERAL INFORMATION:

NOTE: The typical beam angle will be changed by different color, chip size and chip position tolerance. The typical total beam angle is the full angle measured where the luminous intensity is half of the peak value.

Due to use of high power COB's with this product, special attention to proper thermal design is highly recommended. LEDiL has no liability for direct, indirect or consecutive damages arising from the LEDiL products being used outside of the recommended temperature range.

#### MATERIALS:

As part of our continuous research and improvement processes, and to ensure the best possible quality and availability of our products, LEDiL reserves the right to change material grades without notice.

#### PRODUCT DATA USER AGREEMENT AND DISCLAIMER:

The measured data in the provided downloadable LEDiL Product Datasheets and Mechanical 2D-Drawings is rounded and provided as reference for planning. LEDiL Oy's optical specifications have been verified by conducting performance testing of the products in accordance with the company's quality system. The reported data are averaged results of multiple measurements with typical variation. LEDiL Oy reserves the right to without prior notification make changes and improvements to its products.

LEDiL Oy assumes neither warranty, nor guarantee nor any other liability of any kind for the contents and correctness of the provided data. The provided data has been generated with highest diligence but the provided data may in reality not represent the complete possible variation range of all intrinsic parameters. Therefore, in certain cases a deviation from the provided data could occur.

LEDiL Oy reserves the right to undertake technical changes of its products without further notification which could lead to changes in the provided data. LEDiL Oy assumes no liability of any kind for the possible deviation from any provided data or any other damage resulting from the usage of the provided data.

The user agrees to this disclaimer and user agreement with the download or usage of the provided files.

#### LEDiL Oy

Joensuunkatu 13  
FI-24240 SALO  
Finland

#### LEDiL Inc.

228 West Page Street  
Suite D  
Sycamore IL 60178  
USA

#### Local sales and technical support

[www.ledil.com/where\\_to\\_buy](http://www.ledil.com/where_to_buy)

#### Shipping locations

Salo, Finland  
Hong Kong, China

#### Distribution Partners

[www.ledil.com/where\\_to\\_buy](http://www.ledil.com/where_to_buy)