

## NAU8224 Evaluation Board User Manual



*NAU8224 Evaluation kit contents:*

1. NAU8224 Evaluation Board (EVB)
2. NAU-ES\_MINI\_USB – USB to 2-wire interface dongle
3. USB cable
4. GUI installation disc.

## 1. General Description

The NAU8224 is a stereo high efficiency filter-free Class-D audio amplifier, which is capable of driving a 4Ω load with up to 3W output power. This device provides chip enable pin with extremely low standby current and fast start-up time. The ability to configure with either single-ended or differential inputs is included. The NAU8224 has four selectable gain settings of 0dB, 6dB, 12dB, 18dB and 24dB, which can be controlled by a single gain pin. The NAU8224 also has the provision for finer volume control using the 2-wire bus (I2C style) and the bundled GUI. With

87dB PSRR, 91% efficiency, ultra low quiescent current (i.e. 2.1mA at 3.7V for 2 channels) and superior EMI performance the NAU8224 is ideal for the portable applications of battery drive.

## 2. GUI installation procedure

The following steps will describe the installation procedure for the GUI

1. Select the installation package, NAU8224SetupVx.x.EXE, the current version is 1.1



2. The installation will commence and the following screen appears. Click Next.

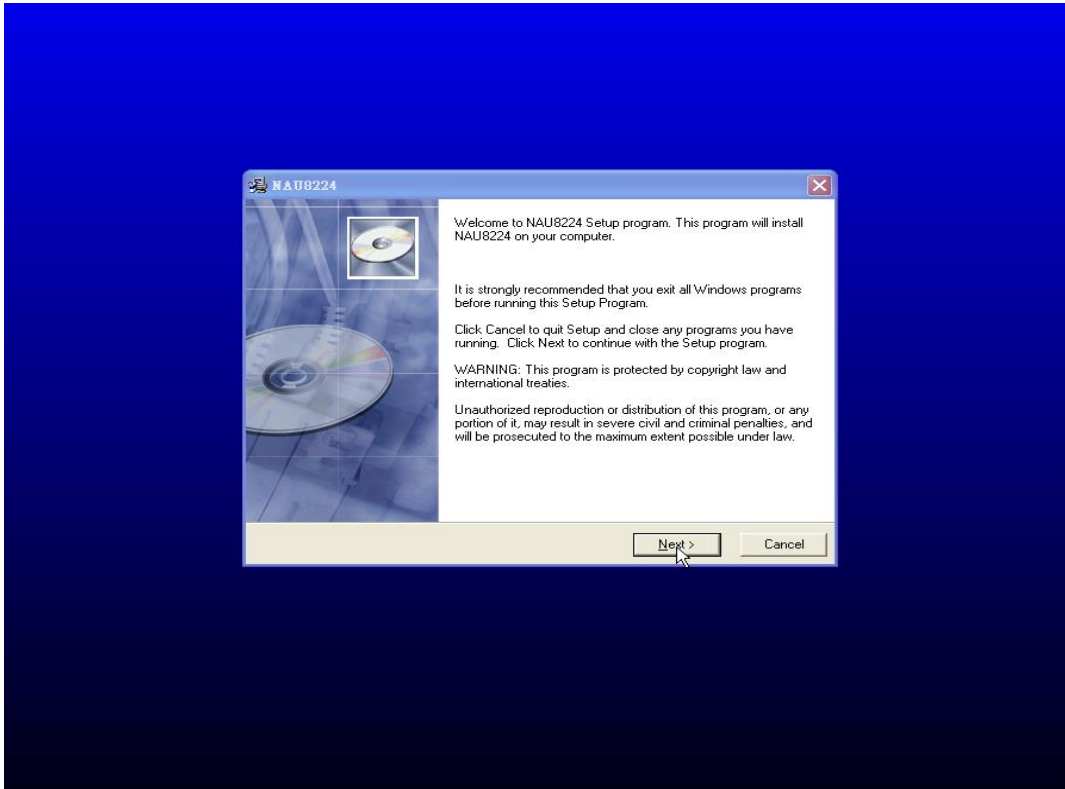

3. The next step is to select the installation directory location. You can use the default location or select a different location using the Browse button and setting the path. Once done, click on Next.

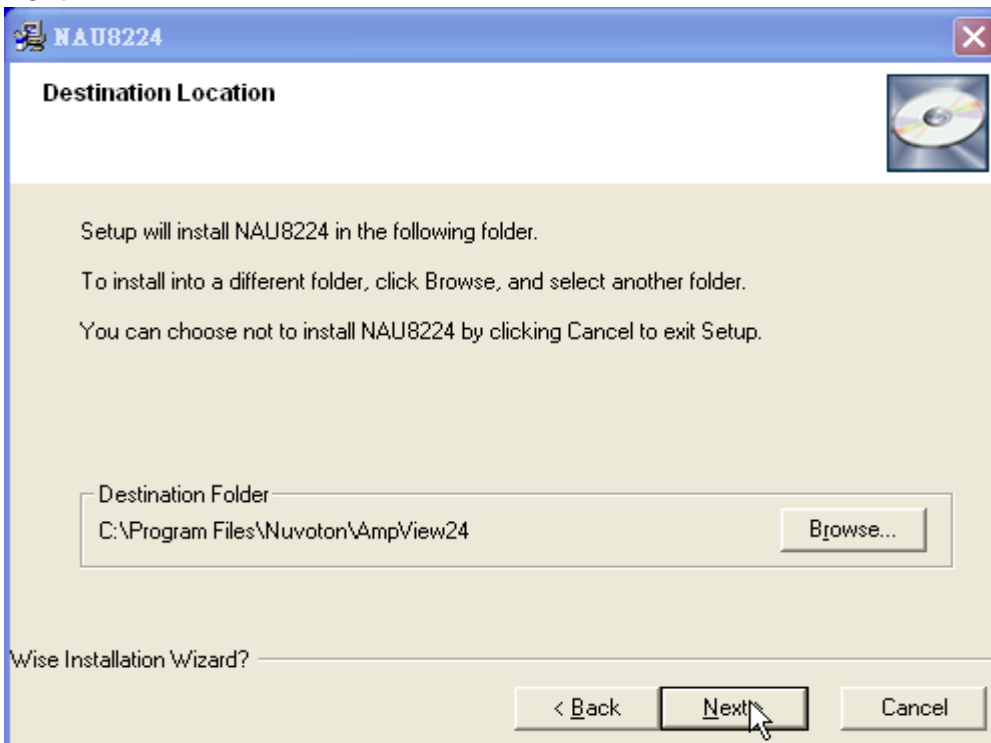

4. Click the Next button to continue the installation process.

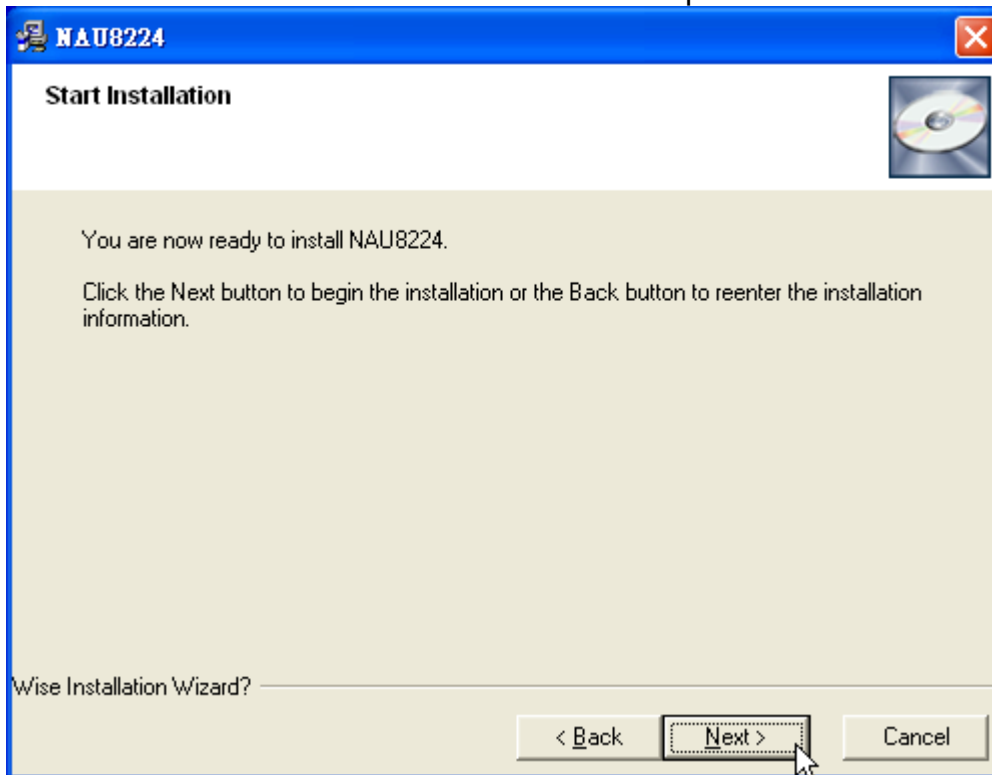

5. The installer will now begin installation procedure and the following progress bar will be displayed. Once done click on the Next button.

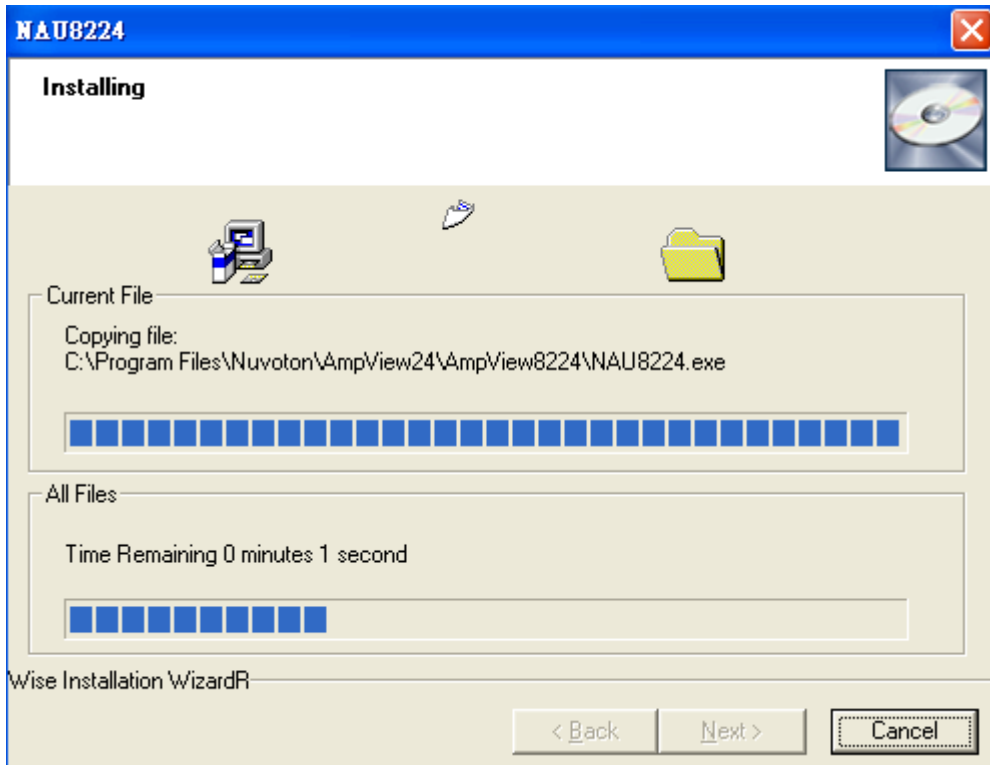

6. Click on Finish to complete the installation and exit.

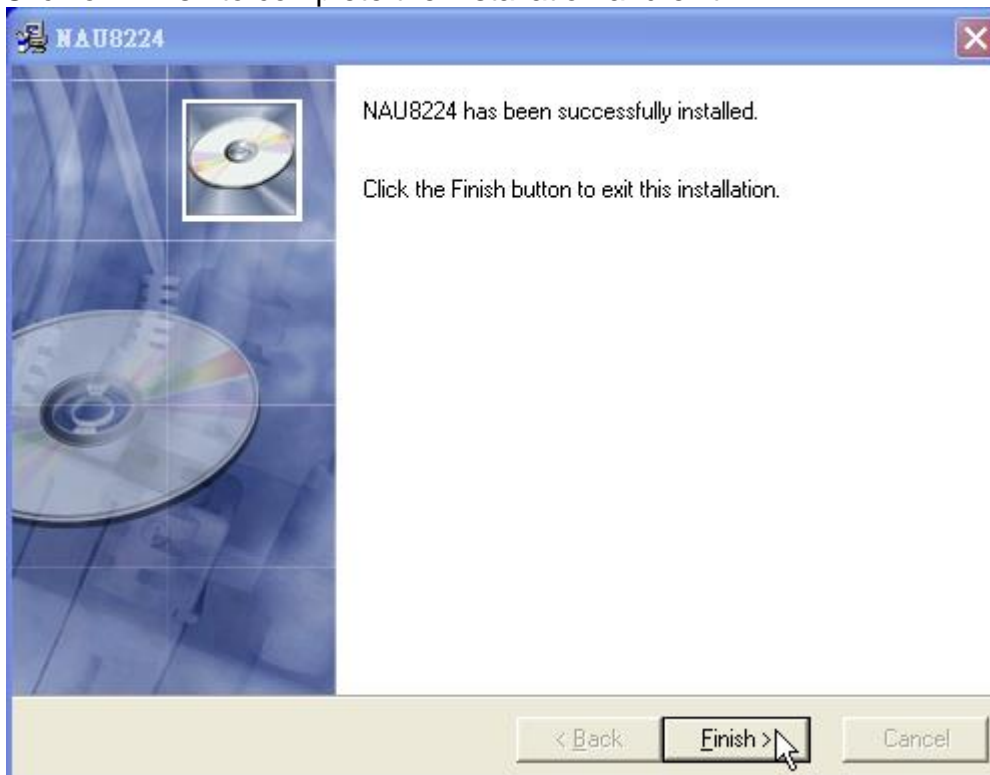

- The GUI will appear under Nuvoton ClassD under All Programs. Click on NAU8224 to launch the GUI.



### 3. EVB Set Up

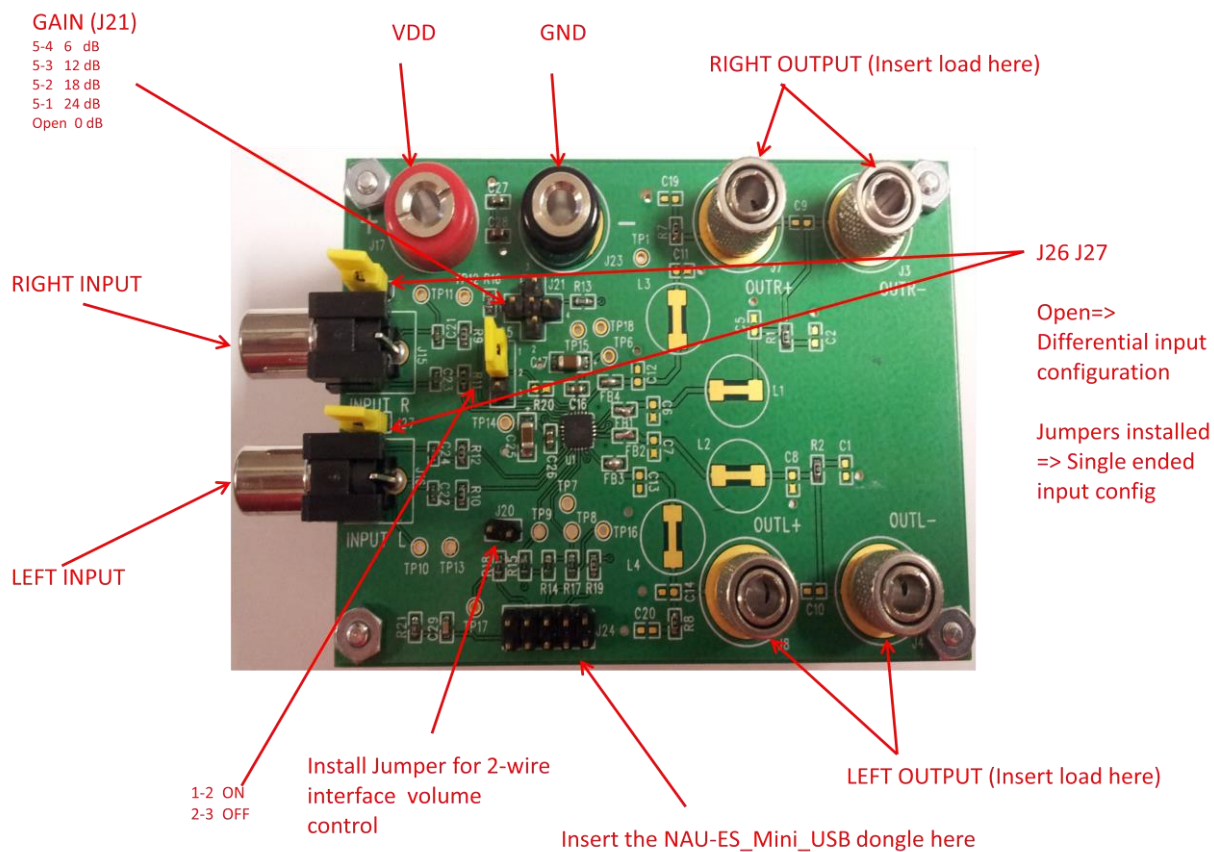

## Power Connection

An external DC Voltage supply with a compliance of at least 2 Amperes should be connected to J17 & J23. The supply leads should be kept short in order to avoid I x R supply voltage drop at the amplifier.

## Jumper Settings

Install J25 on Pins 1-2 to turn ON the device, installing it on 2-3 turns the device OFF.

J21 is for Gain setting. J21 open means setting the gain of the device to 0dB. Installing a jumper in the following pins sets the gain of the device as follows:

5-4: (Center – Right Pin) 6dB  
5-3: (Center – Top Pin) 12dB  
5-2: (Center -- Left Pin) 18dB  
5-1: (Center – Bottom Pin) 24dB.

Install J20 for enabling the 2 wire interface volume control via the USB using the bundled dongle in the kit.

## Input Connection

Jumpers J26 and J27 are for selecting the input configuration mode to either, single ended (install jumpers) or differential (no jumpers installed).

## Output Connection

An 8 ohm 68uH load should be connected on each channel (J3- J7) and (J4 - J8). Connect the outputs to the inputs of the Audio Precision Analyzer (Balanced) via the AP0025 Aux Filter.

## Power Up

For optimum performance the board should be power up with J25 in the power down state. Once the power is applied J25 can be set to power up the board. Then, the input signal can be applied.

### Important note:

When using a power supply, it is recommended to use a 330µF capacitor across the power pins to suppress any supply glitches, as a safety measure. When a battery is used, the capacitor is not required. In normal applications too, the capacitor is not required.

## 2 wire interface header

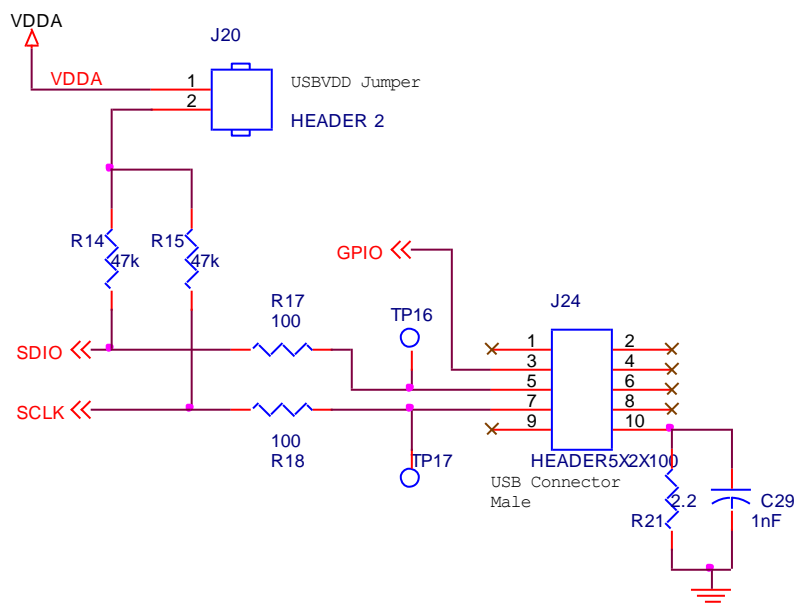

The EVB has a 10 pin header which includes a 2 wire interface to control the volume for finer gain settings. The section of the schematic is shown above. In order to be able to control volume using this interface, J20 jumper must be installed. This connects the header to the NAU8224 volume control pins. Pin 3 is a GPIO pin which connects to the enable (EN) pin of the chip. Pins 5 and 7 are the serial Data and Serial clock lines. An external 2-wire master can be used to send the commands. The bundled USB dongle could be used to control the volume using the NAU8224 GUI. Pin 10 is the ground pin.





### 5. NAU8224 GUI

The NAU8224 evaluation kit comes along with the NAU-ES\_MINI\_USB dongle and GUI to control the volume.

The GUI has just a single screen and has a very simple layout. Once installed the GUI shows up as below

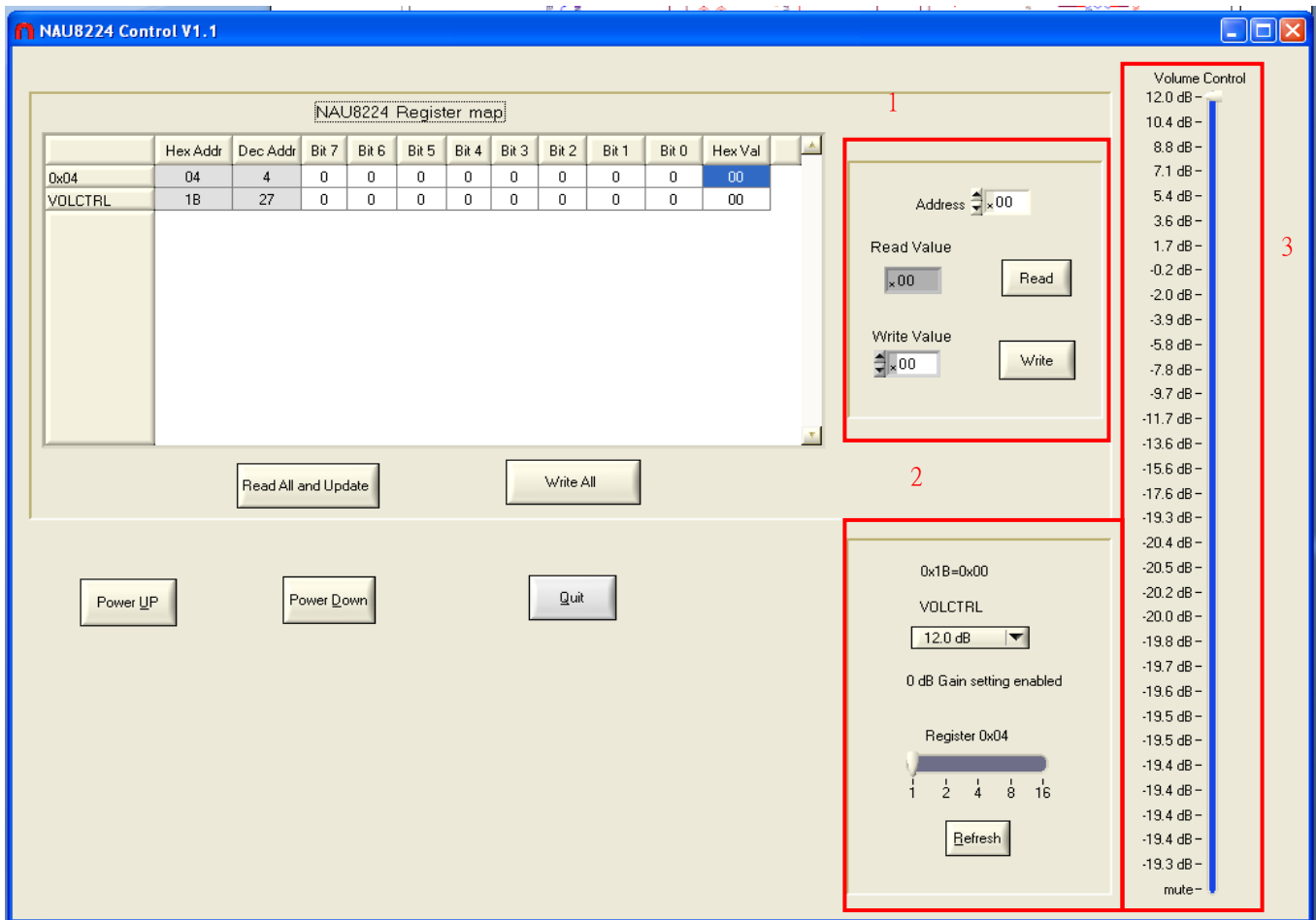

The first step is to hit the Power Up button. This will ensure any changes in the register settings are written to the register map of the chip.

The register map shows the two main registers for the Gain and Volume control. The Gain register address is 0x04 and is a read only register and gets updated depending up the jumper setting of J25.

The volume control register VOLCTRL has address 0x1B and is a read/write register. The value can

be programmed using the text box and buttons on panel 1 or by moving the slider on panel 3.

Panel 2 is used to reflect the value of the read only register 0x04 or the Gain setting of jumper J25.

The Read All and Update button is used to reflect the changes in the register values in the register map. For example if the Gain jumper is changed on the board, to reflect the changes in the register map the Read all and update button must be clicked.

The Quit button is used to exit from the GUI.

## 1 Revision History

VERSION	DATE	PAGE/ CHAP.	DESCRIPTION
V.05	Oct. 8, 2013	-	First Release.
V1.0	April, 2016	-	Updated content

### Important Notice

Nuvoton products are not designed, intended, authorized or warranted for use as components in systems or equipment intended for surgical implantation, atomic energy control instruments, airplane or spaceship instruments, transportation instruments, traffic signal instruments, combustion control instruments, or for other applications intended to support or sustain life. Furthermore, Nuvoton products are not intended for applications wherein failure of Nuvoton products could result or lead to a situation where personal injury, death or severe property or environmental damage could occur.

Nuvoton customers using or selling these products for use in such applications do so at their own risk and agree to fully indemnify Nuvoton for any damages resulting from such improper use or sales.

---

Please note that all data and specifications are subject to change without notice. All the trademarks of products and companies mentioned in this datasheet belong to their respective owners.