

APT15DQ120KG
Datasheet
Ultrafast Soft Recovery Rectifier Diode

Final
March 2018



Contents

1	Revision History	1
1.1	Revision J	1
1.2	Revision I	1
1.3	Revision H	1
1.4	Revision G	1
1.5	Revision F	1
1.6	Revision E	1
1.7	Revision D	1
1.8	Revision C	1
1.9	Revision B	2
1.10	Revision A	2
2	Product Overview	3
2.1	Features	3
2.2	Benefits	3
2.3	Applications	3
3	Electrical Specifications	4
3.1	Absolute Maximum Ratings	4
3.2	Electrical Performance	4
3.3	Typical Performance Curves	6
3.4	Reverse Recovery Overview	8
4	Package Specification	9
4.1	Package Outline Drawing	9

1 Revision History

The revision history describes the changes that were implemented in the document. The changes are listed by revision, starting with the most current publication.

1.1 Revision J

Revision J was published in March 2017. The following is a summary of the changes in revision J of this document.

- Updated bullets in Product Overview section.
- Removed square wave 50% duty cycle in the Absolute Maximum Ratings table.

1.2 Revision I

Revision I was published in January 2017. The following is a summary of the changes in revision I of this document.

- Updated features section.

1.3 Revision H

Revision H was published in July 2016. The following is a summary of the changes in revision H of this document.

- Updated K pack dimensions.

1.4 Revision G

Revision G was published in January 2016. The following is a summary of the changes in revision G of this document.

- Revised the K pack outline.

1.5 Revision F

Revision F was published in May 2011. The following is a summary of the changes in revision F of this document.

- Updated B pack information changing the maximum lead thickness.

1.6 Revision E

Revision E was published in March 2009. The following is a summary of the changes in revision E of this document.

- Updated K pack and removed thermal ladder.

1.7 Revision D

Revision D was published in November 2008. The following is a summary of the changes in revision D of this document.

- Updated K pack drawing outline in the Product Overview section.
- Changed APT references to Microsemi.

1.8 Revision C

Revision C was published in October 2006. There were no changes to the technical content in revision C of this document.

1.9 Revision B

Revision B was published in August 2005. The following is a summary of the changes in revision B of this document.

- The I_{RM} value in Table 2 Static Characteristics was updated.

1.10 Revision A

Revision A was published in May 2005. It is the first publication of this document.

2 Product Overview

This section outlines the product overview for the APT15DQ120KG device.

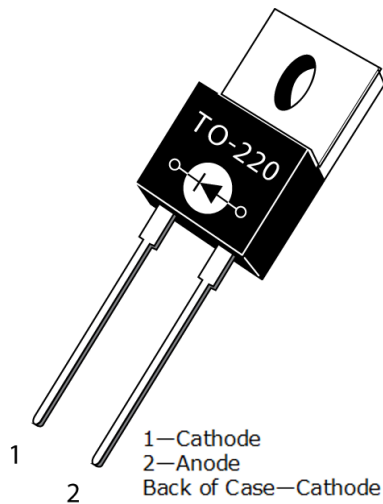

2.1 Features

The following are key features of the APT15DQ120KG device:

- Ultrafast recovery times
- Soft recovery characteristics
- Low forward voltage
- Low leakage current
- Avalanche energy rated
- RoHS compliant
- AEC-Q101 qualified

2.2 Benefits

The following are benefits of the APT15DQ120KG device:

- Higher switching frequency
- Low switching losses
- Low noise (EMI) switching
- Higher reliability systems
- Increased system power density

2.3 Applications

The APT15DQ120KG device is designed for the following applications:

- Power factor correction (PFC)
- Anti-parallel diode
 - Switch-mode power supply
 - Inverters/converters
 - Motor controllers
- Freewheeling diode
 - Switch-mode power supply
 - Inverters/converters
- Snubber/clamp diode

3 Electrical Specifications

This section details the electrical specifications for the APT15DQ120KG device.

3.1 Absolute Maximum Ratings

The following table shows the absolute maximum ratings for the APT15DQ120KG device.

All ratings taken at $T_c = 25\text{ }^\circ\text{C}$, unless otherwise specified.

Table 1 • Absolute Maximum Ratings

Symbol	Parameter	Ratings	Unit
V_R	Maximum DC reverse voltage	1200	V
V_{RRM}	Maximum peak repetitive reverse voltage	1200	
V_{RWM}	Maximum working peak reverse voltage	1200	
$I_{F(AV)}$	Maximum average forward current ($T_c = 127\text{ }^\circ\text{C}$, duty cycle = 0.5)	15	A
$I_{F(RMS)}$	RMS forward current	29	
I_{FSM}	Non-repetitive forward surge current ($T_J = 45\text{ }^\circ\text{C}$, 8.3 ms)	110	
E_{AVL}	Avalanche energy (1 A, 40 mH)	20	mJ
T_J, T_{STG}	Operating and storage temperature range	-55 to 175	$^\circ\text{C}$
T_L	Lead temperature for 10 seconds	300	

3.2 Electrical Performance

The following table shows the static characteristics of the APT15DQ120KG device.

Table 2 • Static Characteristics

Symbol	Characteristic	Test Conditions	Min	Typ	Max	Unit
V_F	Forward Voltage	$I_F = 15\text{ A}$		2.8	3.3	V
		$I_F = 30\text{ A}$		3.4		
		$I_F = 15\text{ A}, T_J = 125\text{ }^\circ\text{C}$		2.45		
I_{RM}	Maximum reverse leakage current	$V_R = 1200\text{ V}$			100	μA
		$V_R = 1200\text{ V}, T_J = 125\text{ }^\circ\text{C}$			500	
C_J	Junction capacitance	$V_R = 200\text{ V}$		17		pF

The following table shows the dynamic characteristics of the APT15DQ120KG device.

Table 3 • Dynamic Characteristics

Symbol	Characteristic	Test Conditions	Min	Typ	Max	Unit
t_{rr}	Reverse recovery time	$I_F = 1\text{ A}$ $di_F/dt = -100\text{ A}/\mu\text{s}$ $V_R = 30\text{ V}$ $T_J = 25\text{ }^\circ\text{C}$		21		ns
t_{rr}	Reverse recovery time	$I_F = 15\text{ A}$		240		
Q_{rr}	Reverse recovery charge	$di_F/dt = -200\text{ A}/\mu\text{s}$, $V_R = 800\text{ V}$		260		nC
I_{RRM}	Maximum reverse recovery current	$T_J = 25\text{ }^\circ\text{C}$		3		A
t_{rr}	Reverse recovery time	$I_F = 15\text{ A}$		290		ns
Q_{rr}	Reverse recovery charge	$di_F/dt = -200\text{ A}/\mu\text{s}$ $V_R = 800\text{ V}$		960		nC
I_{RRM}	Maximum reverse recovery current	$T_J = 125\text{ }^\circ\text{C}$		6		A
t_{rr}	Reverse recovery time	$I_F = 15\text{ A}$		130		ns
Q_{rr}	Reverse recovery charge	$di_F/dt = -1000\text{ A}/\mu\text{s}$ $V_R = 800\text{ V}$		1340		nC
I_{RRM}	Maximum reverse recovery current	$T_J = 125\text{ }^\circ\text{C}$		19		A

The following table shows the thermal and mechanical characteristics of the APT15DQ120KG device.

Table 4 • Thermal and Mechanical Characteristics

Symbol	Characteristic	Min	Typ	Max	Unit
$R_{\theta JC}$	Junction-to-case thermal resistance			1.18	$^\circ\text{C}/\text{W}$
W_T	Package weight		0.07		oz
			1.9		g
Torque	Maximum mounting torque			10	lb-in
				1.1	N-m

3.3 Typical Performance Curves

This section shows the typical performance curves for the APT15DQ120KG device.

Figure 1 • Maximum Transient Thermal Impedance

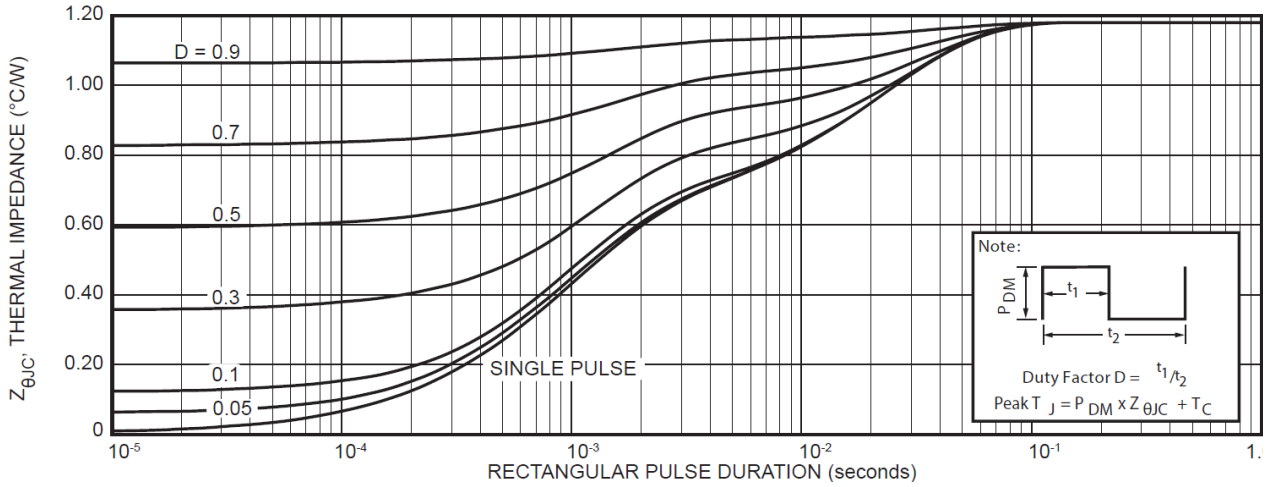

Figure 2 • Forward Current vs. Forward Voltage

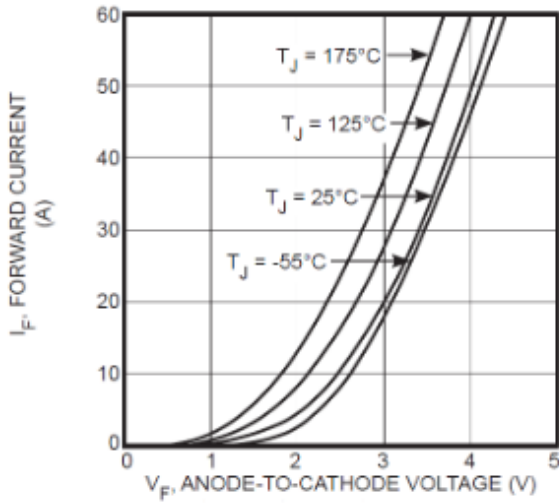

Figure 3 • trr vs. Current Rate of Change

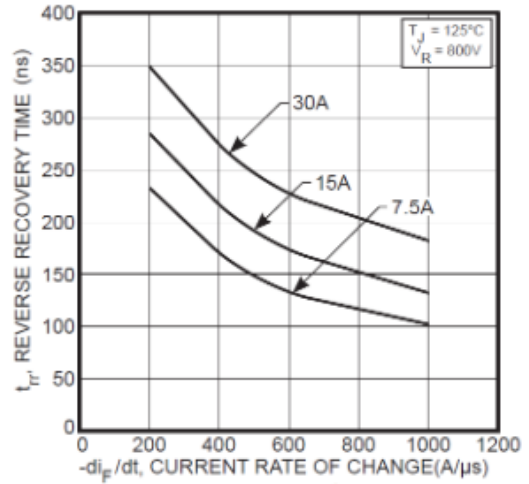

Figure 4 • Q_{rr} vs. Current Rate of Change

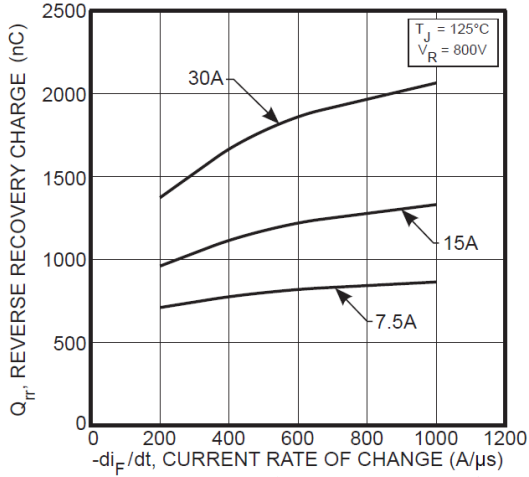

Figure 5 • IRRM vs. Current Rate of Change

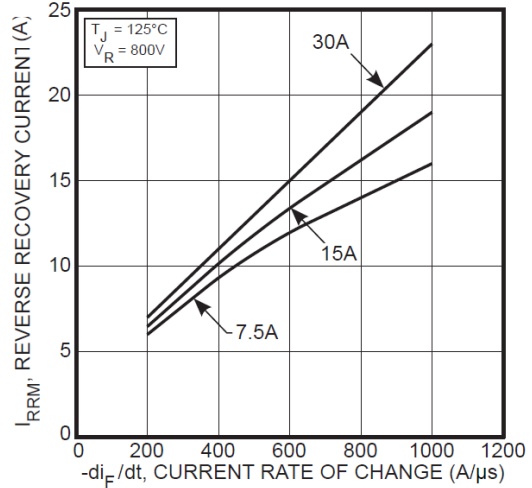

Figure 6 • Dynamic Parameters vs. Junction Temperature

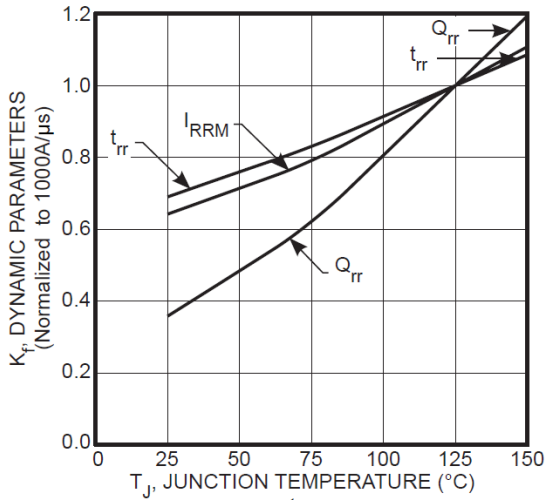

Figure 7 • Maximum Average Forward Current vs. Case Temperature

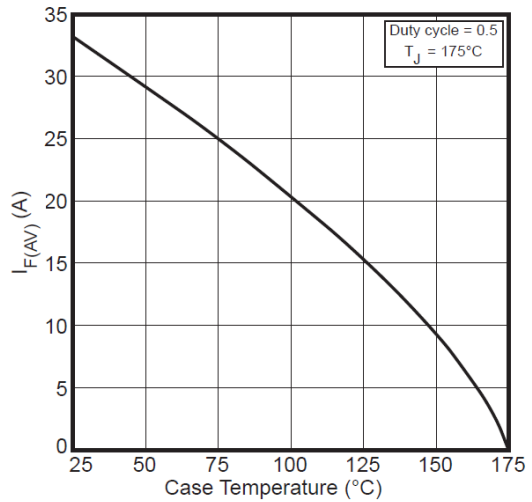
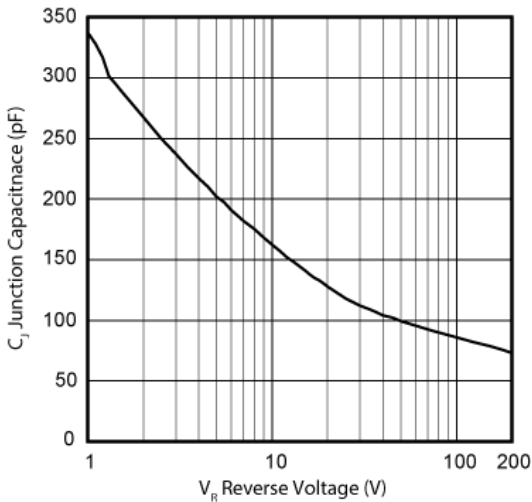

Figure 8 • Junction Capacitance vs. Reverse Voltage



3.4 Reverse Recovery Overview

The following figures illustrate the reverse recovery testing and measurement information for the APT15DQ120KG device.

Figure 9 • Diode Test Circuit

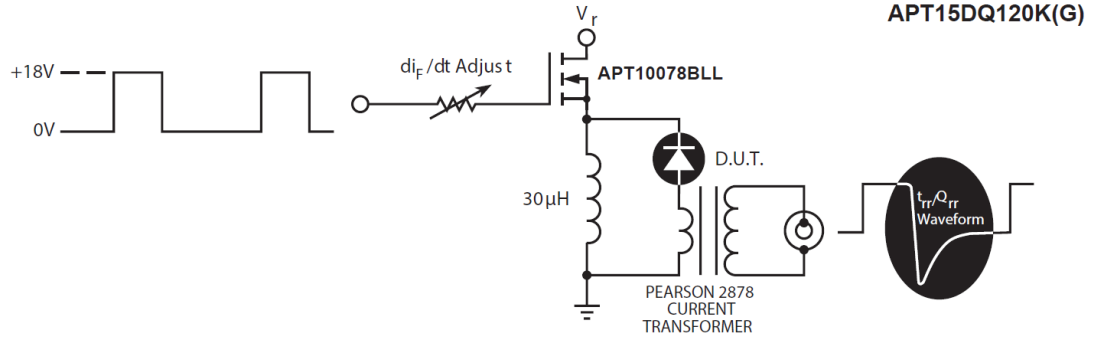
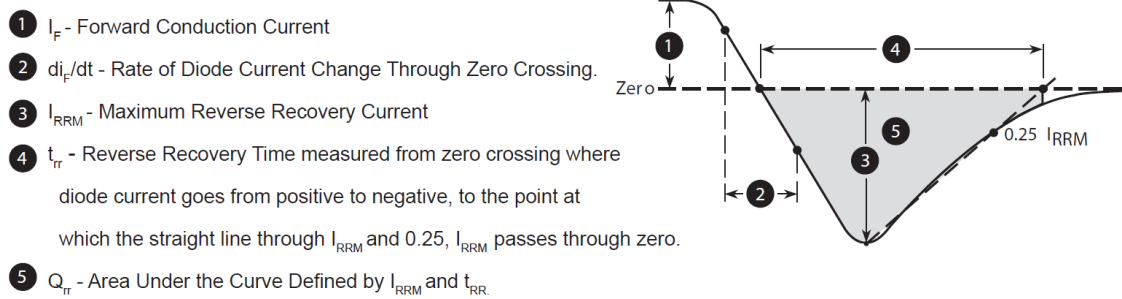

Figure 10 • Diode Reverse Recovery Waveform Definition



4 Package Specification

This section outlines the package specification for the APT15DQ120KG device.

4.1 Package Outline Drawing

This section details the TO-220 package drawing of the APT15DQ120KG device. Dimensions are in millimeters and (inches).

Figure 11 • Package Outline Drawing

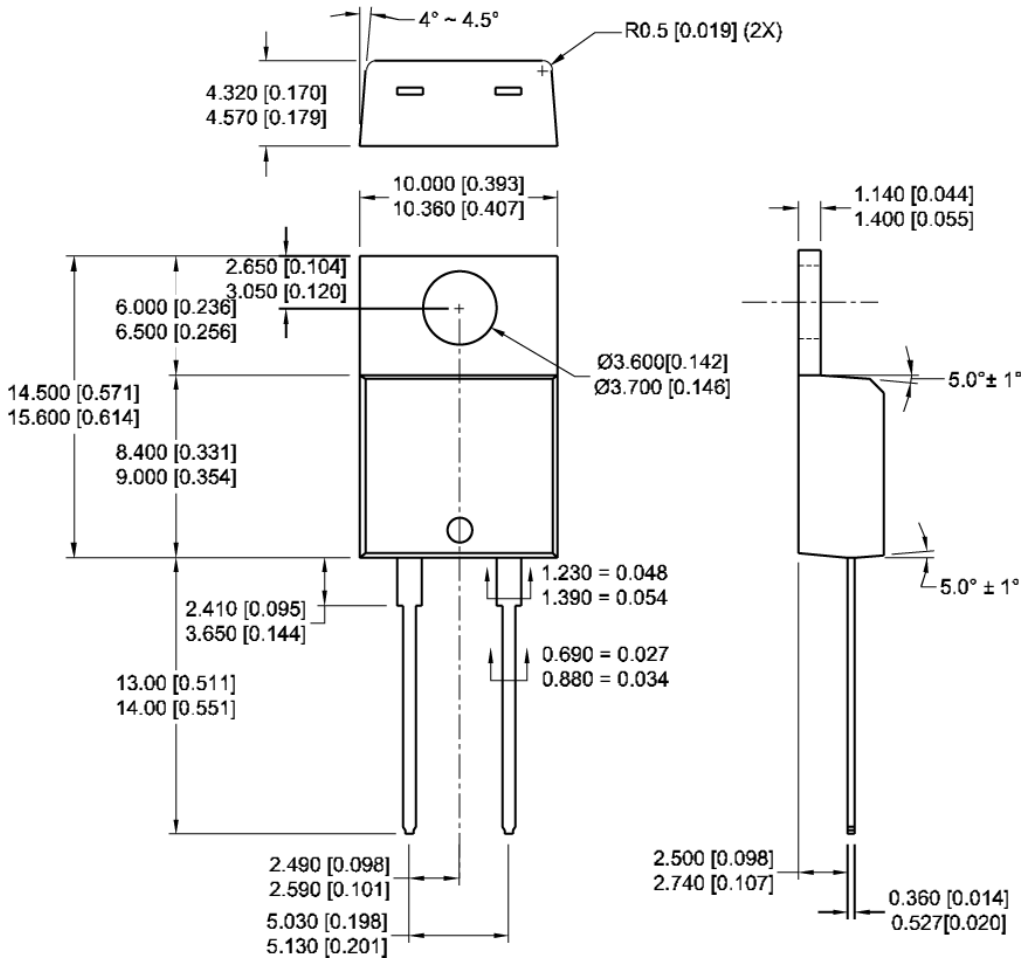

**Microsemi Corporate Headquarters**

One Enterprise, Aliso Viejo,
 CA 92656 USA
 Within the USA: +1 (800) 713-4113
 Outside the USA: +1 (949) 380-6100
 Fax: +1 (949) 215-4996
 Email: sales.support@microsemi.com
www.microsemi.com

© 2018 Microsemi Corporation. All rights reserved. Microsemi and the Microsemi logo are trademarks of Microsemi Corporation. All other trademarks and service marks are the property of their respective owners.

Microsemi makes no warranty, representation, or guarantee regarding the information contained herein or the suitability of its products and services for any particular purpose, nor does Microsemi assume any liability whatsoever arising out of the application or use of any product or circuit. The products sold hereunder and any other products sold by Microsemi have been subject to limited testing and should not be used in conjunction with mission-critical equipment or applications. Any performance specifications are believed to be reliable but are not verified, and Buyer must conduct and complete all performance and other testing of the products, alone and together with, or installed in, any end-products. Buyer shall not rely on any data and performance specifications or parameters provided by Microsemi. It is the Buyer's responsibility to independently determine suitability of any products and to test and verify the same. The information provided by Microsemi hereunder is provided "as is, where is" and with all faults, and the entire risk associated with such information is entirely with the Buyer. Microsemi does not grant, explicitly or implicitly, to any party any patent rights, licenses, or any other IP rights, whether with regard to such information itself or anything described by such information. Information provided in this document is proprietary to Microsemi, and Microsemi reserves the right to make any changes to the information in this document or to any products and services at any time without notice.

Microsemi Corporation (Nasdaq: MSCC) offers a comprehensive portfolio of semiconductor and system solutions for aerospace & defense, communications, data center and industrial markets. Products include high-performance and radiation-hardened analog mixed-signal integrated circuits, FPGAs, SoCs and ASICs; power management products; timing and synchronization devices and precise time solutions, setting the world's standard for time; voice processing devices; RF solutions; discrete components; enterprise storage and communication solutions; security technologies and scalable anti-tamper products; Ethernet solutions; Power-over-Ethernet ICs and midspans; as well as custom design capabilities and services. Microsemi is headquartered in Aliso Viejo, California, and has approximately 4,800 employees globally. Learn more at www.microsemi.com.

053-4222