



MAX17065 Evaluation Kit

Evaluates: MAX17065

General Description

The MAX17065 evaluation kit (EV kit) is a fully assembled and tested surface-mount PCB that evaluates the high-efficiency MAX17065 organic LED (OLED) driver. The MAX17065 EV kit operates from a +2.3V to +4.5V single power supply and includes dual switch-mode power-supply (SMPS) outputs, one LDO, and dual regulated charge pumps for an OLED panel.

The MAX17065 EV kit provides an on-board I²C/SMBus™ interface and is connected to the computer through the universal serial bus (USB) port. The EV kit includes Windows® 2000/XP- and Windows Vista®-compatible software that provides a graphical user interface (GUI) for control of the MAX17065's output voltages, switching frequency, operating mode, current limit, and SMPS and charge-pump enables.

SMBus is a trademark of Intel Corp.

Windows and Windows Vista are registered trademarks of Microsoft Corp.

Features

- ◆ +2.3V to +4.5V Input Range
- ◆ 85% Efficiency (VIN = +3.3V, IVP = IVN = 120mA)
- ◆ +5.35V/120mA Positive and -4.5V/120mA Negative SMPS (-5V to -0.5V Adjustable Negative SMPS, Component Change Required)
- ◆ +1.9V/60mA LDO
- ◆ +6.5V/2mA Positive and -4V/2mA Negative Regulated Charge Pumps (+5.5V to +9V Adjustable Positive and -5V to -0.5V Adjustable Negative Charge Pump)
- ◆ 1.2MHz PWM Switching Frequency (Selectable 600kHz, Component Change Required)
- ◆ On-Board I²C/SMBus Interface Control Through USB
- ◆ Shutdown Control
- ◆ Fully Assembled and Tested

Ordering Information

PART	TYPE	PC INTERFACE
MAX17065EVKIT+	EV Kit	USB

+Denotes lead-free and RoHS-compliant.

Component List

DESIGNATION	QTY	DESCRIPTION
C1, C12, C14	3	10μF ±10%, 16V X5R ceramic capacitors (0805) KEMET C0805C106K4PACTU
C2, C3	2	22pF ±5%, 50V C0G ceramic capacitors (0603) Murata GRM1885C1H220J or TDK C1608C0G1H220J
C4	1	0.033μF ±10%, 16V X5R ceramic capacitor (0603) Taiyo Yuden EMK107BJ333KA
C5–C10, C17, C18, C28, C29, C30, C34	12	0.1μF ±10%, 16V X7R ceramic capacitors (0603) TDK C1608X7R1C104K Murata GRM188R71C104K
C11, C13, C19, C20, C21, C35–C39	10	1μF ±10%, 16V X7R ceramic capacitors (0603) Murata GRM188R71C105K TDK C1608X5R1C105K
C15, C16	2	10pF ±5%, 50V C0G ceramic capacitors (0603) Murata GRM1885C1H100J TDK C1608C0G1H100J

DESIGNATION	QTY	DESCRIPTION
C22	1	0.01μF ±10%, 50V X7R ceramic capacitor (0603) Murata GRM188R71H103K TDK C1608X7R1H103K
C23	1	2200pF ±10%, 50V X7R ceramic capacitor (0603) Murata GRM188R71H222K TDK C1608X7R1H222K
C24, C25	2	470pF ±10%, 50V X7R ceramic capacitors (0603) Murata GRM188R71H471K TDK C1608X7R1H471K
C26	1	2.2μF ±10%, 10V X5R ceramic capacitor (0603) Murata GRM188R61A225K TDK C1608X5R0J225K
C27, C31, C32	3	4.7μF ±10%, 10V X5R ceramic capacitors (0805) Murata GRM219R61A475K TDK C2012X5R1A475K

*EP = Exposed pad.



MAX17065 Evaluation Kit

Component List (continued)

DESIGNATION	QTY	DESCRIPTION
C33	1	10 μ F \pm 10%, 6.3V X5R ceramic capacitor (0603) TDK C1608X5R0J106K Murata GRM188R60J106M
H1	0	Not installed, 2 x 5-pin JTAG header
JU1	1	2-pin header
JU2, JU5, JU6	3	3-pin headers
JU3, JU4	0	Not installed, 2-pin headers
L1	1	Ferrite bead (0603) TDK MMZ1608R301A Murata BLM18SG700 TN1
L2, L3	2	4.7 μ H, 0.75A, 0.18 Ω inductors TDK VLF3010ST-4R7MR75 Taiyo Yuden NR3010T4R7M (0.24 Ω)
P1	1	USB series-B right-angle PC-mount receptacle Assmann Electronic AU-Y1007-R
R1, R2	2	27 Ω \pm 5% resistors (0603)
R3	1	1.5k Ω \pm 5% resistor (0603)
R4	1	470 Ω \pm 5% resistor (0603)
R5	1	2.2k Ω \pm 5% resistor (0603)
R6	1	10k Ω \pm 5% resistor (0603)
R7	1	169k Ω \pm 1% resistor (0603)
R8	1	100k Ω \pm 1% resistors (0603)
R9–R13	0	Not installed, resistors—short by PCB trace (0402)
R14, R15	2	33.2k Ω \pm 1% resistors (0603)
R16	0	Not installed, resistor—short by PCB trace (0603)
R17	1	1M Ω \pm 5% resistor (0603)
R18–R21	0	Not installed, resistors (0603)
R22, R23	2	100 Ω \pm 1% resistors (0603)
U1	1	OLED driver (28 TQFN) Maxim MAX17065ETI+
U2	1	Microcontroller (68 QFN-EP*) Maxim MAXQ2000-RAX+
U3	1	2.5V LDO regulator (5 SO70) Maxim MAX8511EXK25+

DESIGNATION	QTY	DESCRIPTION
U4	1	Adjustable output LDO regulator (5 SO70) Maxim MAX8512EXK+
U5	1	UART-to-USB converter FTDI FT232BL (32 TQFP)
U6	1	93C46 type 3-wire EEPROM Atmel AT93C46A-10SU-2.7 (8 SO)
U7, U8	2	Logic level translators (10 μ MAX [®]) Maxim MAX1840EUB+
Y1	1	16MHz crystal
Y2	1	6MHz crystal
—	4	Shunts
—	1	PCB: MAX17065 Evaluation Kit+

*EP = Exposed pad.

Component Suppliers

SUPPLIER	PHONE	WEBSITE
Assmann Electronic	480-897-7001	www.assmann.com
KEMET Corp.	864-963-6300	www.kemet.com
Murata Electronics North America, Inc.	770-436-1300	www.murata-northamerica.com
Taiyo Yuden	800-348-2496	www.t-yuden.com
TDK Corp.	847-803-6100	www.component.tdk.com

Note: Indicate that you are using the MAX17065 when contacting these component suppliers.

MAX17065 EV Kit Files

FILE	DESCRIPTION
INSTALL.EXE	Installs the EV kit files on your computer
MAX17065.EXE	Application program
FTD2XX.INF	USB Driver file
UNINST.INI	Uninstalls the EV kit software
TROUBLESHOOTING_USB.PDF	USB driver installation help file

μ MAX is a registered trademark of Maxim Integrated Products, Inc.

MAX17065 Evaluation Kit

Evaluates: MAX17065

Quick Start

Recommended Equipment

Before beginning, the following equipment is needed:

- MAX170655 EV kit (USB cable included)
- A user-supplied Windows® 2000/XP or Windows Vista PC
- +2.3V to +4.5V, 1A power supply (VIN)
- Available USB port

Note: In the following sections, software-related items are identified by bolding. Text in **bold** refers to items directly from the EV kit. Text in **bold and underlined** refers to items from the Windows operating system.

Procedure

The MAX17065 EV kit is fully assembled and tested. Follow the steps below to verify board operation.

Caution: Do not turn on the power supply until all connections are completed.

- 1) Visit www.maxim-ic.com/evkitsoftware to download the latest version of the EV kit software, 17065Rx.ZIP. Save the EV kit software to a temporary folder and uncompress the ZIP file.
- 2) Install the EV kit software on your computer by running the INSTALL.EXE program. The program files are copied and icons are created in the Windows **Start** menu.
- 3) Verify that jumpers are in their default positions as follows:

JUMPER	SHUNT POSITION
JU1	Installed
JU2, JU5, JU6	1-2

- 4) Connect the positive terminal of the VIN power supply to the VIN pad. Connect the ground terminal of the VIN power supply to the PGND pad.
- 5) Connect the USB cable from the PC to the EV kit board. A **Building Driver Database** window pops up in addition to a **New Hardware Found** message when installing the USB driver for the first time. If you do not see a window that is similar to the one

described above after 30 seconds, remove the USB cable from the board and reconnect it. Administrator privileges are required to install the USB device driver on Windows. Refer to the TROUBLESHOOTING_USB.PDF document included with the software if you have any problems during this step.

- 6) Follow the directions of the **Add New Hardware Wizard** to install the USB device driver. Choose the **Search for the best driver for your device** option. Specify the location of the device driver to be **C:\Program Files\MAX17065** (default installation directory) using the **Browse** button.
- 7) Set the VIN power supply and enable its output.
- 8) Start the MAX17065 program by opening its icon in the **Start** menu.
- 9) Normal device operation is verified when **CMAXQUSB HW: Connected. MAX17065 device connected.** is displayed at the bottom left of the MAX17065 EV kit window.
- 10) Set the switching frequency = 1.2MHz, negative SMPS = -4.5V, positive and negative current limits = 0.7A, positive charge-pump output = +6.5V, and negative charge-pump output = -4V (Figure 1).

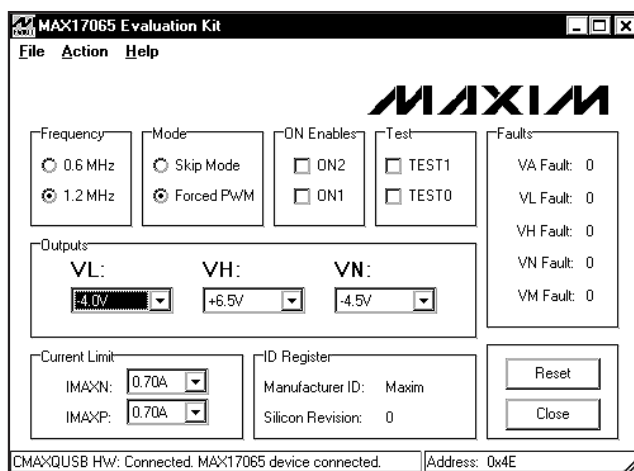

Figure 1. MAX17065 EV Kit Software Suggested Setup

MAX17065 Evaluation Kit

Detailed Description of Software

User-Interface Panel

The program's main window (Figure 2) is navigated by using a mouse or a combination of the Tab and Arrow keys. The MAX17065 EV kit software provides controls for the following software-configurable features: **Frequency** and **Mode** selection, **ON Enables**, **Outputs** configuration, **Faults** detection, **Current Limit** settings, and **Manufacturer ID/Silicon Revision** detection. Changes to the controls result in a write operation that updates the appropriate registers of the MAX17065. A status bar is also provided at the bottom of the program's main window and is used to verify command module and device connectivity. A **Device Search** option is located in the **Action** menu bar should the user want to switch from **Demo Mode** to normal operation.

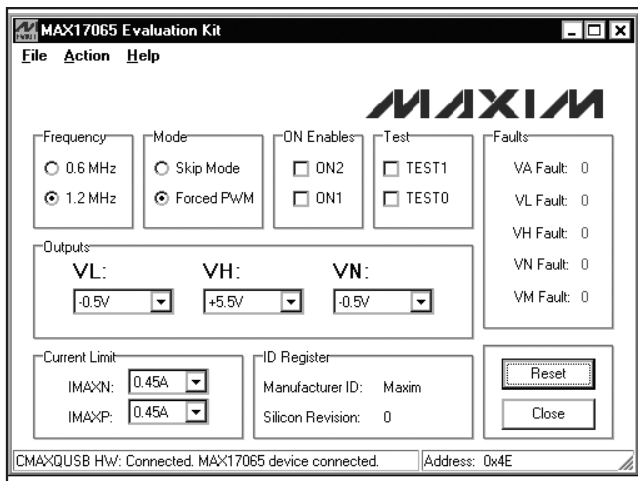

Figure 2. MAX17065 EV Kit Software Main Window

Frequency Selection

The MAX17065 can be operated at either 0.6MHz or 1.2MHz. To set the desired frequency, select the appropriate radio button in the **Frequency** group box. The default frequency setting is 0.6MHz, but the EV kit is designed for 1.2MHz. Component changes are required when selecting different frequencies. Refer to the MAX17065 IC data sheet for more information regarding frequency selection.

Operating Mode

The MAX17065 can be operated in either **Skip Mode** or **Forced PWM**. To set the desired operating mode, select the appropriate radio button in the **Mode** group box. The default operating mode is **Forced PWM**. Refer to the MAX17065 IC data sheet for more information regarding modes of operation.

ON Enables and Test

The **ON2** and **ON1** bits enable/disable the various outputs of the MAX17065, according to Table 1. To set either bit high, check the respective **ON_** checkbox in the **ON Enables** group box.

Table 1. ON2 and ON1 Control

ON2	ON1	VA OUTPUT	VH, VL OUTPUTS	VP, VN OUTPUTS
0	0	Off	Off	Off
0	1	On	On	Off
1	0	On	On	On
1	1	On	On	On

Setting **TEST1** and **TEST0** checkboxes prevents the VL, VH, VP, and VN outputs. In this mode, the output can be driven by external voltage sources. Setting either **TEST_** bit to 1 in the **Test** group box disables the discharge function. Refer to the MAX17065 IC data sheet for more information regarding the test bits.

Fault Detection

The MAX17065's **Faults** read-only register monitors the OLED controller's operating state, output, and thermal faults. When a fault is detected, the corresponding bit is changed from logic 0 to logic 1 and the font color is changed to red. Refer to the MAX17065 IC data sheet for more information regarding the **Faults** register.

Outputs

The MAX17065 allows for software control of the charge-pump and negative SMPS outputs. Select the appropriate voltages from the **VL:**, **VH:**, and **VN:** drop-down lists to set the desired voltages. The default settings are **VL: -0.5V**, **VH: +5.5V**, and **VN: -0.5V**.

Current Limit

The MAX17065 software allows the user to set current limits for the negative and positive switching power supplies. To set the current limits, select the desired current limit from the **IMAXN:** and **IMAXP:** drop-down lists in the **Current Limit** group box. The default current-limit settings are **IMAXN: 0.45A** and **IMAXP: 0.45A**.

Manufacturer ID/Silicon Revision Detection

The **ID Register** group box shows the manufacturer ID and silicon revision information of the MAX17065 IC. This information is read upon initial start-up.

MAX17065 Evaluation Kit

Evaluates: MAX17065

Simple I²C/SMBus Commands

There are two methods for communicating with the MAX17065: through the normal user-interface panel (Figure 2) or through the I²C/SMBus commands, available by selecting the **Interface Diagnostic Window** menu item from the **Action** menu bar. The **Maxim Command Module Interface** window pops up and includes a **2-wire interface** tab that allows for execution of simple I²C/SMBus commands.

The SMBus dialog boxes accept numeric data in binary, decimal, or hexadecimal. Hexadecimal numbers should be prefixed by \$ or 0x. Binary numbers must be exactly eight digits. See Figure 3 for an illustration of this tool.

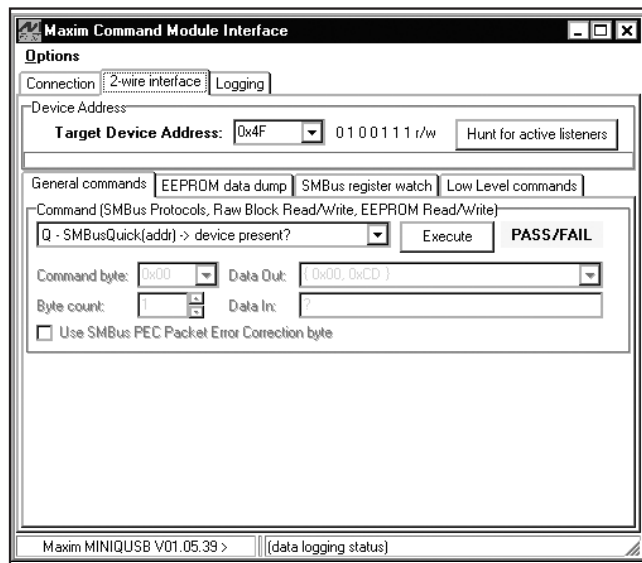

Figure 3. Interface Diagnostic Window

Detailed Description of Hardware

The MAX17065 evaluation kit (EV kit) is a fully assembled and tested surface-mount PCB that evaluates the high-efficiency MAX17065 organic LED (OLED) driver. The MAX17065 EV kit provides an on-board I²C/SMBus interface and is connected to the computer through the USB port. The EV kit includes Windows 2000/XP- and Windows Vista-compatible software that provides a GUI for control of the MAX17065's output voltages, switching frequency, operating mode, current limit, and SMPS and charge-pump enables. The MAX17065 EV kit operates from a +2.3V to +4.5V single power supply.

The MAX17065 includes dual SMPS outputs (+5.35 fixed positive and -5V to -0.5V adjustable negative), one LDO (+1.9V/60mA), and dual regulated charge pumps (+5.5V to +9V positive and -5V to -0.5V negative) for an OLED panel.

Shutdown Control

The MAX17065 can be placed in shutdown mode through jumper JU1 (see Table 2). When connected to GND or left open, the VD output is enabled with four rising CLK edges. When connected to VDDIO, the MAX17065's VD is enabled without a CLK signal.

Table 2. Jumper JU1 Function

SHUNT POSITION	SHDN PIN	LDO OUTPUT (VD)
Installed*	Connected to VDDIO	Always on
One pin	Internally connected to GND	Enabled with four rising CLK edges

*Default position.

User-Supplied VDDIO Input

The MAX17065's VDDIO supply is powered from the USB port by default. Move the shunt of JU2 to the 2-3 position to apply your own +1.6V to +3.6V power supply at the VDDIO pad. See Table 3 for jumper JU2 configuration. VDDIO voltage decides the SHDN and CLK logic levels. When CLK is driven by an external signal, jumper JU2 can be placed in a 2-3 position to allow external VDDIO voltage.

Table 3. Jumper JU2 Function

SHUNT POSITION	VDDIO PIN
1-2*	Powered from +3.3V USB supply
2-3	Powered from external +1.6V to +3.6V supply

*Default position.

User-Supplied I²C/SMBus Interface

To use the MAX17065 EV kit with a user-supplied I²C/SMBus interface, first move the shunts of JU5 and JU6 to the 2-3 position. Then connect your SDA and SCL signals to the corresponding SDA and SCL pads on the MAX17065 EV kit board. **Note:** The I²C/SMBus interface is not available until VD is enabled by either SHDN = VDDIO or four rising CLK edges because SDA and SCL are pulled up by internal 10kΩ resistors.

MAX17065 Evaluation Kit

Evaluates: MAX17065

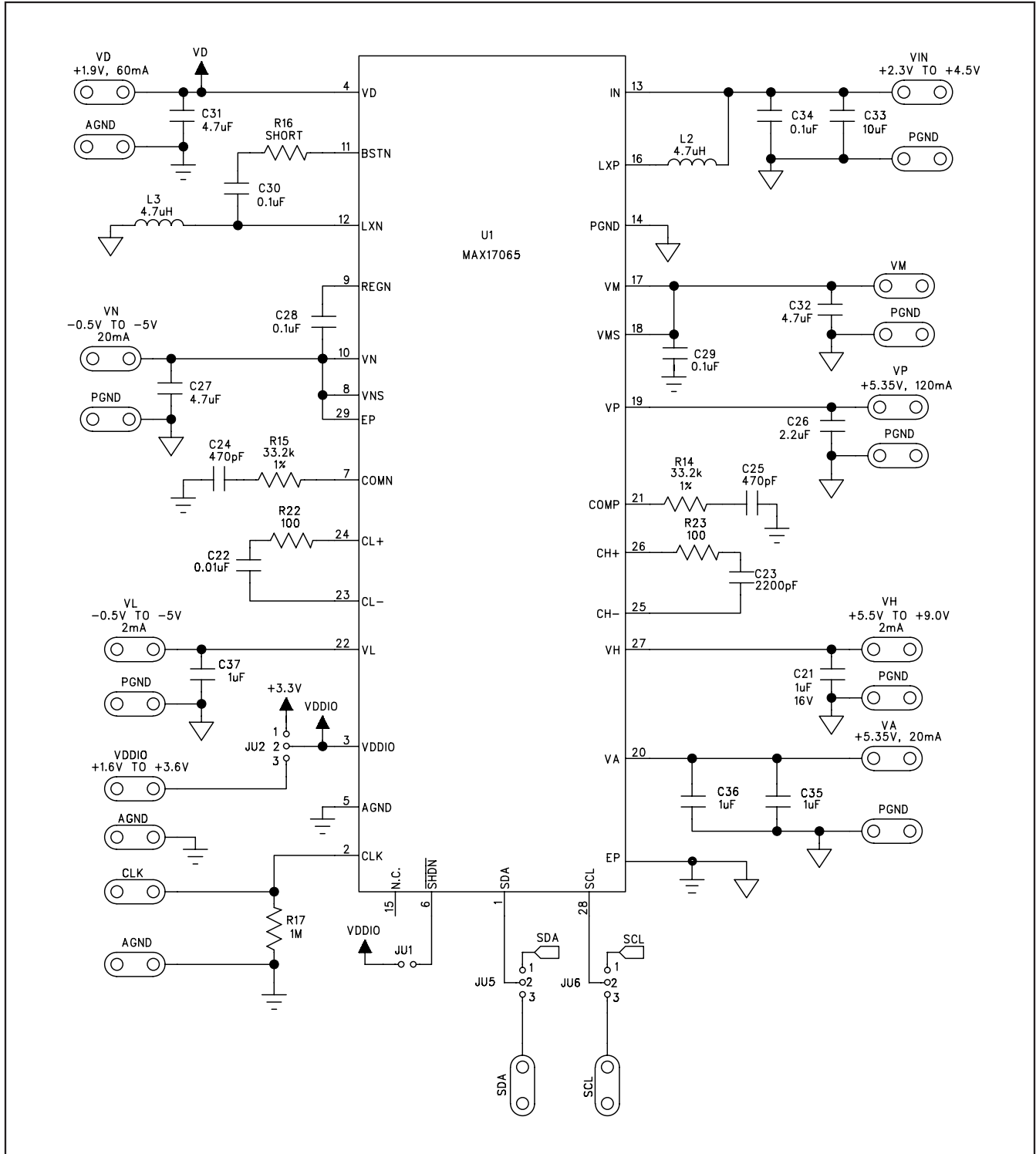

Figure 4a. MAX17065 EV Kit Schematic (Sheet 1 of 2)

MAX17065 Evaluation Kit

Evaluates: MAX17065

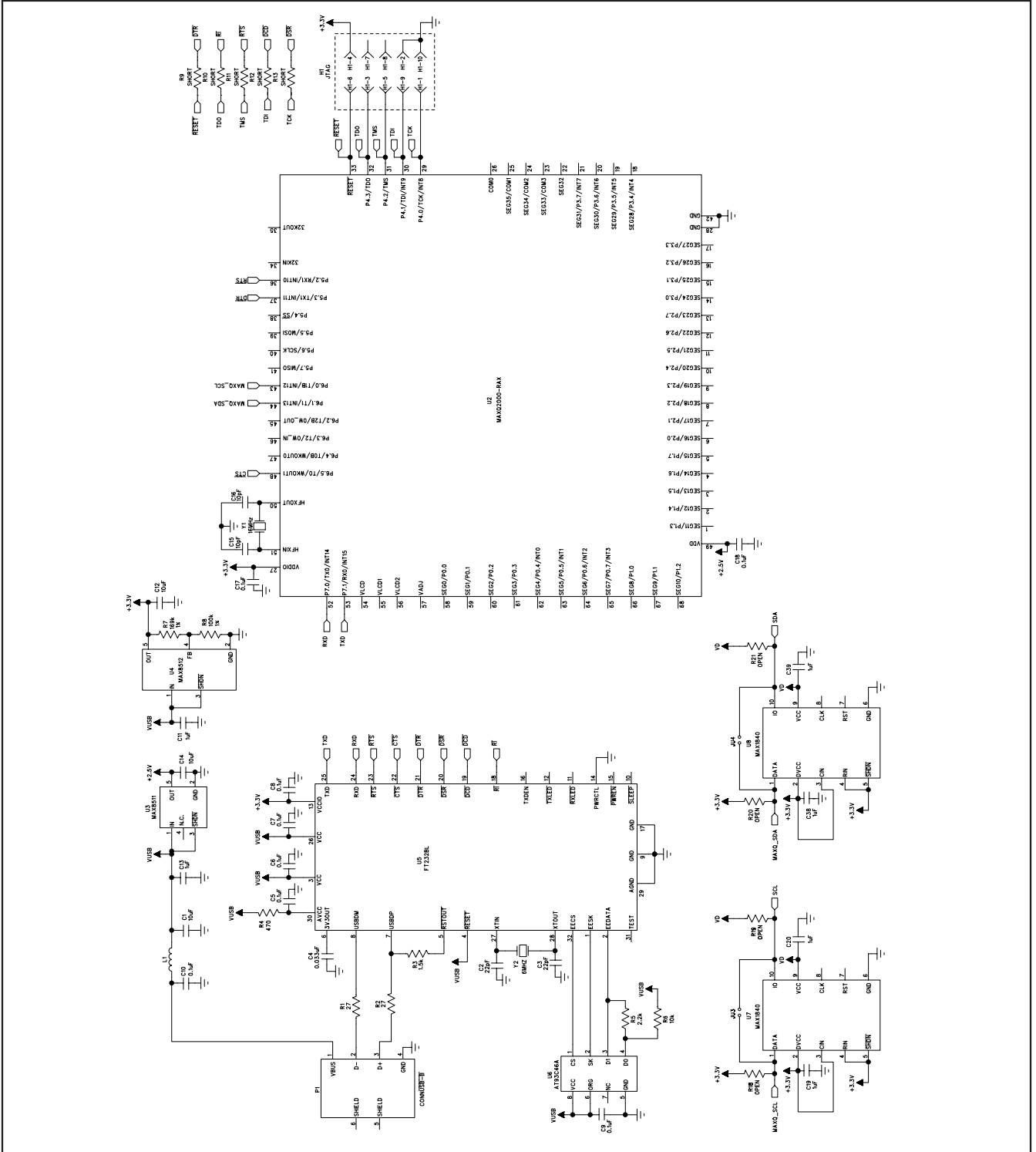

Figure 4b. MAX17065 EV Kit Schematic (Sheet 2 of 2)

MAX17065 Evaluation Kit

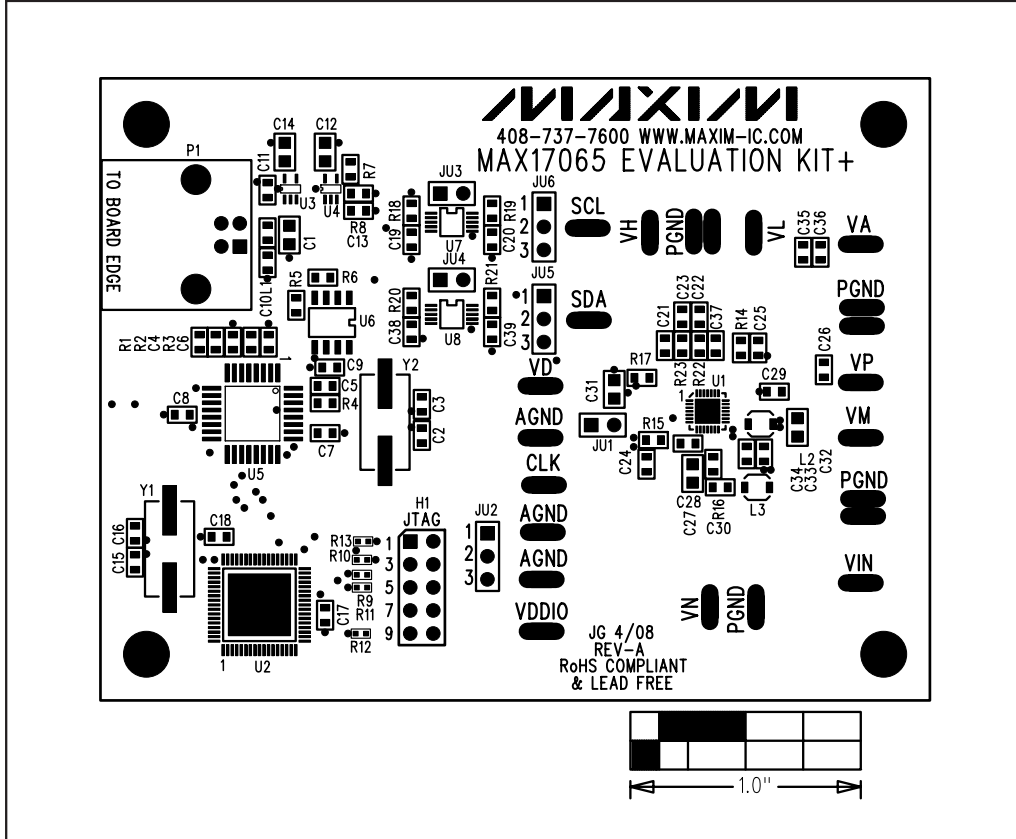

Figure 5. MAX17065 EV Kit Component Placement Guide—Component Side

MAX17065 Evaluation Kit

Evaluates: MAX17065

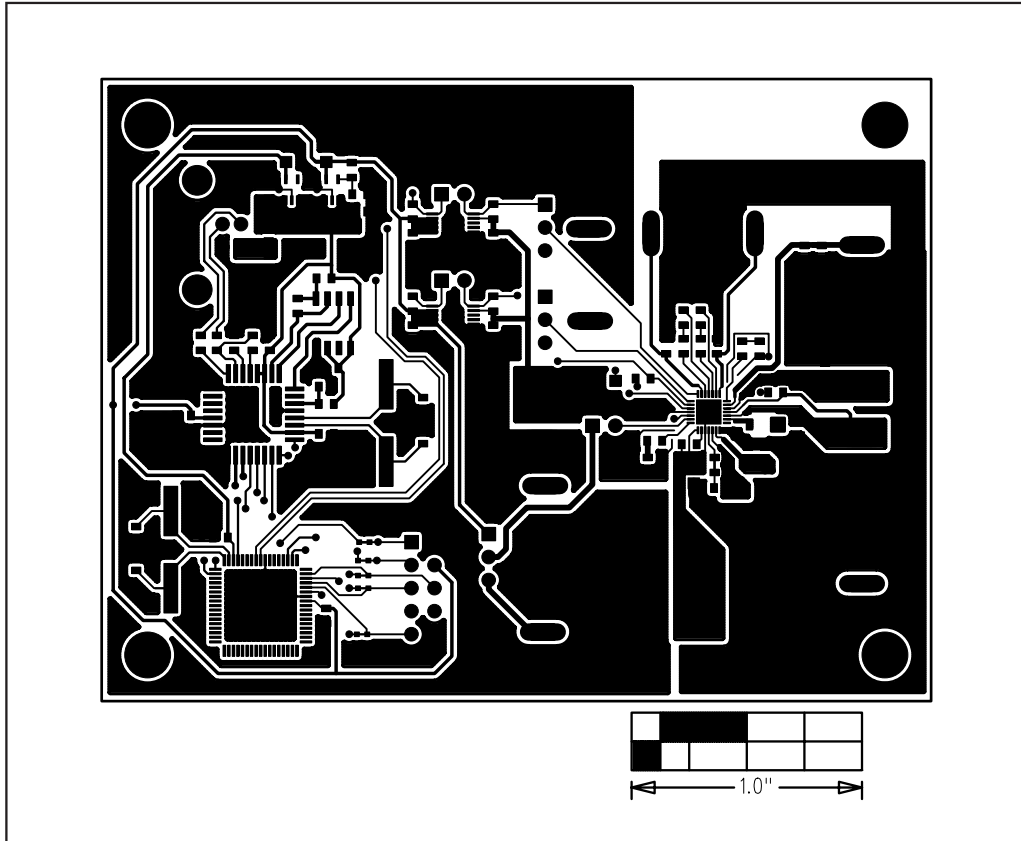

Figure 6. MAX17065 EV Kit PCB Layout—Component Side

MAX17065 Evaluation Kit

Evaluates: MAX17065

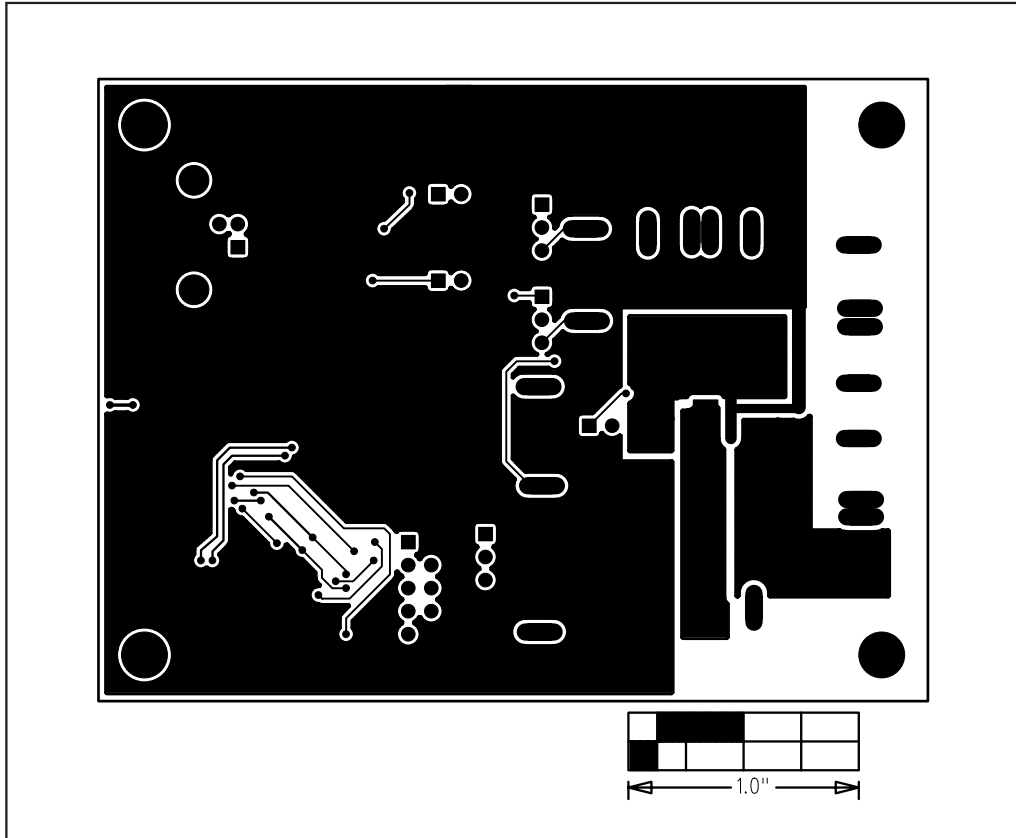

Figure 7. MAX17065 EV Kit PCB Layout—Solder Side

Maxim cannot assume responsibility for use of any circuitry other than circuitry entirely embodied in a Maxim product. No circuit patent licenses are implied. Maxim reserves the right to change the circuitry and specifications without notice at any time.

10 **Maxim Integrated Products, 120 San Gabriel Drive, Sunnyvale, CA 94086 408-737-7600**

© 2008 Maxim Integrated Products

MAXIM is a registered trademark of Maxim Integrated Products, Inc.