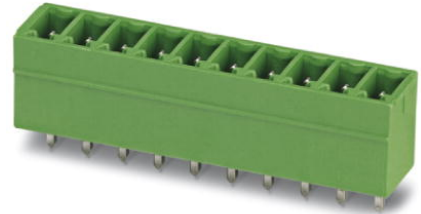

MCV 1,5/13-G-3,81

Order No.: 1803536

The figure shows a 10-position version of the product

<http://eshop.phoenixcontact.de/phoenix/treeViewClick.do?UID=1803536>Header, Nominal current: 8 A, Nom. voltage: 160 V, Pitch: 3.81 mm,
Number of positions: 13, Color: green, Assembly: Soldering

Commercial data

EAN	4017918045845
Pack	50 pcs.
Customs tariff	85366990
Weight/Piece	0.0037 KG
Catalog page information	Page 175 (CC-2009)

Product notes

WEEE/RoHS-compliant since:
01/01/2003

<http://www.download.phoenixcontact.com>
Please note that the data given here has been taken from the online catalog. For comprehensive information and data, please refer to the user documentation. The General Terms and Conditions of Use apply to Internet downloads.

Technical data

Dimensions / positions

Length	7.25 mm
Pitch	3.81 mm
Dimension a	45.72 mm
Number of positions	13
Pin dimensions	0,8 x 0,8 mm

Hole diameter	1.2 mm
Technical data	
Insulating material group	IIIa
Rated surge voltage (III/3)	2.5 kV
Rated surge voltage (III/2)	2.5 kV
Rated surge voltage (II/2)	2.5 kV
Rated voltage (III/2)	160 V
Rated voltage (II/2)	250 V
Connection in acc. with standard	EN-VDE
Nominal current I_N	8 A
Nominal voltage U_N	160 V
Maximum load current	8 A
Insulating material	PBT
Inflammability class acc. to UL 94	V0

Certificates / Approvals



Certification CB, CSA, CUL, GOST, UL, VDE-PZI

CSA

Nominal voltage U_N	300 V
Nominal current I_N	8 A

CUL

Nominal voltage U_N	300 V
Nominal current I_N	8 A

UL

Nominal voltage U_N	300 V
Nominal current I_N	8 A

Accessories

Item	Designation	Description
Marking		
1051993	B-STIFT	Marker pen, for manual labeling of unprinted Zack strips, smear-proof and waterproof, line thickness 0.5 mm
0804109	SK 3,81/2,8:FORTL.ZAHLEN	Marker card, printed horizontally, self-adhesive, 10-section marker strip, 14 identical decades marked 1-10, 11-20 etc. up to 91-(99)100, sufficient for 140 terminal blocks
0805056	SK 3,81/2,8:SO	Marker card, special printing, self-adhesive, labeled acc. to customer requirements, 14 identical marker strips per card, max. 25-position labeling per strip, color: White

Plug/Adapter

1734634	CP-MSTB	Keying profile, is inserted into the slot on the plug or inverted header, red insulating material
---------	---------	---

Additional products

Item	Designation	Description
General		
1851151	FK-MCP 1,5/13-ST-3,81	Plug component, Nominal current: 8 A, Nom. voltage: 160 V, Pitch: 3.81 mm, Number of positions: 13, Connection type: Spring-cage conn., Color: green
1850770	FRONT-MC 1,5/13-ST-3,81	Plug component, Nominal current: 8 A, Nom. voltage: 160 V, Pitch: 3.81 mm, Number of positions: 13, Connection type: Screw connection, Color: green
1862687	IMC 1,5/13-G-3,81	Header, Nominal current: 8 A, Nom. voltage: 160 V, Pitch: 3.81 mm, Number of positions: 13, Color: green, Assembly: Soldering
1875535	IMCV 1,5/13-G-3,81	Header, Nominal current: 8 A, Nom. voltage: 160 V, Pitch: 3.81 mm, Number of positions: 13, Color: green, Assembly: Soldering
1803688	MC 1,5/13-ST-3,81	Plug component, Nominal current: 8 A, Nom. voltage: 160 V, Pitch: 3.81 mm, Number of positions: 13, Connection type: Screw connection, Color: green
1852286	MCC 1/13-STZ-3,81	Plug component, Nominal current: 8 A, Nom. voltage: 160 V, Pitch: 3.81 mm, Number of positions: 13, Connection type: Crimp connection, Color: green
1827237	MCVR 1,5/13-ST-3,81	Plug component, Nominal current: 8 A, Nom. voltage: 160 V, Pitch: 3.81 mm, Number of positions: 13, Connection type: Screw connection, Color: green
1827088	MCVW 1,5/13-ST-3,81	Plug component, Nominal current: 8 A, Nom. voltage: 160 V, Pitch: 3.81 mm, Number of positions: 13, Connection type: Screw connection, Color: green

1897500	QC 0,5/13-ST-3,81	Plug component, Nominal current: 6 A, Nom. voltage: 320 V, Pitch: 3.81 mm, Number of positions: 13, Connection type: Insulation displacement connection QUICKON, Color: green
---------	-------------------	---

Diagrams/Drawings

Drilling plan/solder pad geometry

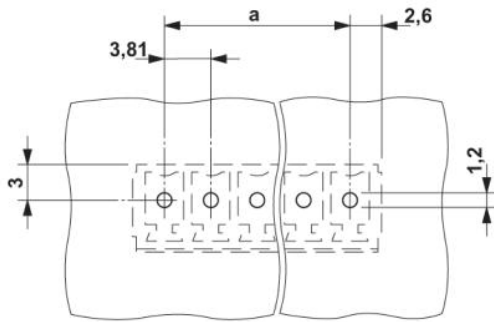

Dimensioned drawing

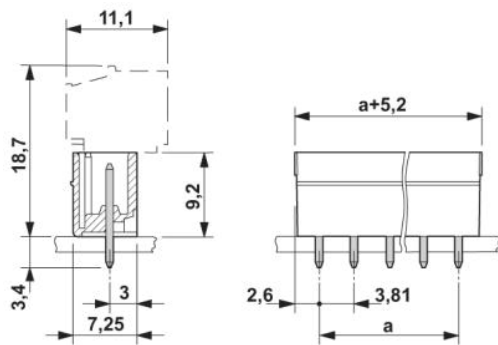

Address

PHOENIX CONTACT Inc., USA
586 Fulling Mill Road
Middletown, PA 17057, USA
Phone (800) 888-7388
Fax (717) 944-1625
<http://www.phoenixcon.com>



© 2010 Phoenix Contact
Technical modifications reserved;